

Mastering Strategic Management

Mastering Strategic Management

[Author removed at request of original publisher]

University of Minnesota Libraries Publishing edition, 2015. This edition adapted from a work originally produced in 2010 by a publisher who has requested that it not receive attribution.

Minneapolis, MN



Mastering Strategic Management by [\[Author removed at request of original publisher\]](#) is licensed under a [Creative Commons Attribution-NonCommercial-ShareAlike 4.0 International License](#), except where otherwise noted.

Publisher Information

Mastering Strategic Management is adapted from a work produced and distributed under a Creative Commons license (CC BY-NC-SA) in 2011 by a publisher who has requested that they and the original author not receive attribution. This adapted edition is produced by the [University of Minnesota Libraries Publishing](#) through the [eLearning Support Initiative](#).

This adaptation has reformatted the original text, and replaced some images and figures to make the resulting whole more shareable. This adaptation has not significantly altered or updated the original 2011 text. This work is made available under the terms of a [Creative Commons Attribution-NonCommercial-ShareAlike license](#).



About the Authors

Mastering Strategic Management is adapted from a work produced by a publisher who has requested that they and the original author not receive attribution. This adapted edition is produced by the University of Minnesota Libraries Publishing through the eLearning Support Initiative. Though the publisher has requested that they and the original author not receive attribution, this adapted edition reproduces all original text and sections of the book, except for publisher and author name attribution.

Unnamed Author

Unnamed Author serves as Lowder Eminent Scholar and Professor of Management at Auburn University. An award-winning educator, Unnamed Author has taught Strategic Management, Principles of Management, and Franchising. His research interests include strategic management, entrepreneurship, research methods, and strategic supply-chain management. He has published more than one hundred articles in journals such as *Administrative Science Quarterly*, *Academy of Management Journal*, and *Strategic Management Journal*. He has served on thirteen editorial boards, including those of *Academy of Management Review*, *Strategic Management Journal*, and *Journal of Management Studies*. He has served as associate editor for seven journals, including *Academy of Management Journal*, *Journal of International Business Studies*, and *Organizational Research Methods*. Unnamed Author serves on the teaching team for the Entrepreneurship Bootcamp for Veterans with Disabilities at Florida State University, has acted as an expert witness, and has assisted a variety of private and public sector entities with strategic planning. He is the former chair of the board of directors for the Alabama Launchpad (a statewide business plan competition) and currently serves on the Steering Committee for the Michelin Development–East Alabama (an entity that provides low-interest loans to fuel job creation).

Unnamed Author



Unnamed Author is the Rath Chair in Strategic Management at the University of Oklahoma. His award-winning teaching includes classes such as Principles of Management, Strategic Management, Entrepreneurship, and Management History. Unnamed Author's research focuses on the determinants of firm and organizational performance. He has published more than fifty articles in such journals as *Strategic Management Journal*, *Organization Science*, *Personnel Psychology*, *Organizational Behavior and Human Decision Processes*, *Academy of Management Learning and Education*, and *Journal of Management Education*, among others. He is an associate editor for the *Journal of Management* and serves on the editorial board of *Organizational Research Methods*. He also coauthored the first Harvard Business School case in graphic novel format.

Acknowledgments

We would like to thank the following reviewers. Their insightful feedback and suggestions for improving the material helped us make this a better text:

- Sonny Ariss, University of Toledo
- Keith Brigham, Texas Tech University
- Kalyan Chakravarty, California State University, Northridge
- Brian Connelly, Auburn University
- Carol Decker, Tennessee Wesleyan College
- Dr. Robert Edmonds, Maritime College, State University of New York
- Jeffrey Fahrenwald, Rockford College
- Barbara Good, Ursuline College
- Samuel Gray, New Mexico State University
- Cynthia Hanevy, Buena Vista University
- Thomas Little, University of Texas at Arlington
- Franz Lohrke, Samford University
- Aaron McKenny, University of Oklahoma
- Elouise Mintz, Saint Louis University
- Todd Moss, Oregon State University
- Jason Myrowitz, University of Wyoming
- Erin Nelson, DePaul University
- Don Neubaum, Oregon State University
- Pankaj Patel, Ball State University
- Paul Tomko, Cuyahoga Community College
- Thomas Towle, University of New Hampshire
- John Upson, University of West Georgia
- David Vequist, University of the Incarnate Word
- Miles Zachary, Texas Tech University
- Gregory Zerovnik, University of La Verne

Dedications

Unnamed Author

To Sharon, my wife and best friend. When the world leaves me flat, you keep me going. You are my harbor in the tempest.

Unnamed Author

To my beautiful wife, Tessa; son, Jack; and daughter, Ella. Thank you for your love and support during this challenging process.

Preface

Teaching strategic management classes can be a very difficult challenge for professors. In most business schools, strategic management is a “capstone” course that requires students to draw on insights from various functional courses they have completed (such as marketing, finance, and accounting) to understand how top executives make the strategic decisions that drive whether organizations succeed or fail. Many students have very little experience with major organizational choices. This undermines many students’ engagement in the course.

Our book is designed to enhance student engagement. A good product in any industry matches what customers want and need, and the textbook industry is no exception. It is well documented that many of today’s students are visual learners. To meet students’ wants and needs (and thereby create a much better teaching experience for professors), our book offers the following:

- **Several graphic displays in each chapter that summarize key concepts in a visually appealing format.** Chapter 1 “Mastering Strategy: Art and Science”, for example, offers graphic displays on (1) the “5 Ps” of strategy; (2) intended, emergent, and realized strategies; (3) strategy in ancient times; (4) military strategy; and (5) the evolution of strategic management as a field of study. The idea for the graphic displays was inspired by the visually rich and popular series on business published by DK Publishing.
- **Rich, illustrative examples drawn from companies that are relevant to many students.** As part of our emphasis on examples, each chapter uses one company as an ongoing example to bring various concepts to life. In Chapter 1 “Mastering Strategy: Art and Science”, Apple is used as the ongoing example.
- **A “strategy at the movies” feature in each chapter that links course concepts with a popular motion picture.** In Chapter 1 “Mastering Strategy: Art and Science”, for example, we describe how *The Social Network* illustrates intended, emergent, and realized strategies.

Meanwhile, working within the business model gives our book a significant price advantage over other textbooks. Politicians in many states are paying more and more attention over time to the cost of a college education, including the high prices of most textbooks. It is therefore reasonable to expect an ever-increasing number of professors to seek modestly priced textbooks. Professors still want to be assured of quality, of course. Both of us are endowed chairs at Research I universities. We have long track records of publishing our research in premier journals, and we have served in a variety of editorial and review board roles for such journals. Finally, we recognize that professors want to minimize their switching costs when adopting a new book. Although every textbook is a little unique, our table of contents offers a structure and topic coverage that parallels what market leading books provide.

Chapter 1: Mastering Strategy: Art and Science

Chapter 1: Mastering Strategy: Art and Science

1.1 Mastering Strategy: Art and Science

1.2 Defining Strategic Management and Strategy

1.3 Intended, Emergent, and Realized Strategies

1.4 The History of Strategic Management

1.5 Understanding the Strategic Management Process

1.6 Conclusion

1.1 Mastering Strategy: Art and Science

Learning Objectives

After reading this chapter, you should be able to understand and articulate answers to the following questions:

1. What are strategic management and strategy?
2. Why does strategic management matter?
3. What elements determine firm performance?

Strategic Management: A Core Concern for Apple



The Opening of the Apple Store

Lucius Kwok – [Apple Store UK Opening Day](#) – CC BY-SA 2.0.

March 2, 2011, was a huge day for Apple. The firm released its much-anticipated iPad2, a thinner and faster

version of market-leading Apple's iPad tablet device. Apple also announced that a leading publisher, Random House, had made all seventeen thousand of its books available through Apple's iBookstore. Apple had enjoyed tremendous success for quite some time. Approximately fifteen million iPads were sold in 2010, and the price of Apple's stock had more than tripled from early 2009 to early 2011.

But future success was far from guaranteed. The firm's visionary founder Steve Jobs was battling serious health problems. Apple's performance had suffered when an earlier health crisis had forced Jobs to step away from the company. This raised serious questions. Would Jobs have to step away again? If so, how might Apple maintain its excellent performance without its leader?

Meanwhile, the iPad2 faced daunting competition. Samsung, LG, Research in Motion, Dell, and other manufacturers were trying to create tablets that were cheaper, faster, and more versatile than the iPad2. These firms were eager to steal market share by selling their tablets to current and potential Apple customers. Could Apple maintain leadership of the tablet market, or would one or more of its rivals dominate the market in the years ahead? Even worse, might a company create a new type of device that would make Apple's tablets obsolete?

1.2 Defining Strategic Management and Strategy

Learning Objectives

1. Learn what strategic management is.
2. Understand the key question addressed by strategic management.
3. Understand why it is valuable to consider different definitions of strategy.
4. Learn what is meant by each of the 5 Ps of strategy.

What Is Strategic Management?

Issues such as those currently faced by Apple are the focus of strategic management because they help answer the key question examined by [strategic management](#)—“Why do some firms outperform other firms?” More specifically, strategic management examines how actions and events involving top executives (such as Steve Jobs), firms (Apple), and industries (the tablet market) influence a firm’s success or failure. Formal tools exist for understanding these relationships, and many of these tools are explained and applied in this book. But formal tools are not enough; creativity is just as important to strategic management. Mastering strategy is therefore part art and part science.

This introductory chapter is intended to enable you to understand what strategic management is and why it is important. Because strategy is a complex concept, we begin by explaining five different ways to think about what strategy involves ([Table 1.1 “Defining Strategy: The Five Ps”](#)). Next, we journey across many centuries to examine the evolution of strategy from ancient times until today. We end this chapter by presenting a conceptual model that maps out one way that executives can work toward mastering strategy. The model also provides an overall portrait of this book’s contents by organizing the remaining nine chapters into a coherent whole.

Defining Strategy: The Five Ps

Defining strategy is not simple. Strategy is a complex concept that involves many different processes and activities within an organization. To capture this complexity, Professor Henry Mintzberg of McGill University in Montreal, Canada, articulated what he labeled as “the 5 Ps of strategy.” According to Mintzberg, understanding how strategy can be viewed as a plan, as a ploy, as a position, as a pattern, and as a perspective is important. Each of these five ways of thinking about strategy is necessary for understanding what strategy is, but none of them alone is sufficient to master the concept (Mintzberg, 1987).

Table 1.1 Defining Strategy: The Five Ps

Plan – a carefully crafted set of steps that a firm intends to follow in order to be successful	Virtually every firm creates a strategic plan to guide its future. Plans are important to individuals too. If you are reading this, you probably have a career plan that requires a college degree.
Ploy – a specific move designed to outwit or trick competitors	A pizzeria owner in Pennsylvania once tried to sabotage his competitors by placing mice in their shops. Although most strategic ploys are legal, this one was not and the perpetrator was arrested.
Pattern – the degree of consistency in a firm’s strategic actions	Apple always responds to competitive challenges by innovating. Some of these innovations are complete busts, but enough are successful that Apple’s overall performance is excellent.
Position – a firm’s place in the industry relative to its competitors	Old Navy offers fashionable clothes at competitive prices. Old Navy is owned by the same corporation as the Gap and Banana Republic; each brand is positioned at a different pricing level.
Perspective – how executives interpret the competitive landscape around them	In the mid-1990s, the Internet was mainly a communication tool for academics and government. Jeff Bezos viewed the Internet as a sales channel and he began selling books online. Today, the company he created—Amazon.com—is a dominant retailer.

Strategy as a Plan

Strategic plans are the essence of strategy, according to one classic view of strategy. A strategic plan is a carefully crafted set of steps that a firm intends to follow to be successful. Virtually every organization creates a strategic plan to guide its future. In 1996, Apple’s performance was not strong, and Gilbert F. Amelio was appointed as chief executive officer in the hope of reversing the company’s fortunes. In a speech focused on strategy, Amelio described a plan that centered on leveraging the Internet (which at the time was in its infancy) and developing multimedia products and services. Apple’s subsequent success selling over the Internet via iTunes and with the iPad can be traced back to the plan articulated in 1996 (Markoff, 1996).

A **business model** should be a central element of a firm’s strategic plan. Simply stated, a business model describes the process through which a firm hopes to earn profits. It probably won’t surprise you to learn that developing a viable business model requires that a firm sell goods or services for more than it costs the firm to create and distribute those goods. A more subtle but equally important aspect of a business model is providing customers with a good or service more cheaply than they can create it themselves.

Consider, for example, large chains of pizza restaurants such as Papa John’s and Domino’s.



Franchises such as Pizza Hut provide an example of a popular business model that has been successful worldwide.

[Wikimedia Foundation](#) – CC BY 2.0.

Because these firms buy their ingredients in massive quantities, they pay far less for these items than any family could (an advantage called [economies of scale](#)). Meanwhile, Papa John's and Domino's have developed specialized kitchen equipment that allows them to produce better-tasting pizza than can be created using the basic ovens that most families rely on for cooking. Pizza restaurants thus can make better-tasting pizzas for far less cost than a family can make itself. This business model provides healthy margins and has enabled Papa John's and Domino's to become massive firms.

Strategic plans are important to individuals too. Indeed, a well-known proverb states that "he who fails to plan, plans to fail." In other words, being successful requires a person to lay out a path for the future and then follow that path. If you are reading this, earning a college degree is probably a key step in your strategic plan for your career. Don't be concerned if your plan is not fully developed, however. Life is full of unexpected twists and turns, so maintaining flexibility is wise for individuals planning their career strategies as well as for firms.

For firms, these unexpected twists and turns place limits on the value of strategic planning. Former heavyweight boxing champion Mike Tyson captured the limitations of strategic plans when he noted, "Everyone has a plan until I punch them in the face." From that point forward, strategy is less about a plan and more about adjusting to a shifting situation. For firms, changes in the behavior of competitors, customers, suppliers, regulators, and other external groups can all be sources of a metaphorical punch in the face. As events unfold around a firm, its strategic plan may reflect a competitive reality that no longer exists. Because the landscape of business changes rapidly, other ways of thinking about strategy are needed.

Strategy as a Ploy

A second way to view strategy is in terms of ploys. A [strategic ploy](#) is a specific move designed to outwit or trick competitors. Ploys often involve using creativity to enhance success. One such case involves the mighty Mississippi River, which is a main channel for shipping cargo to the central portion of the United States. Ships traveling the river

enter it near New Orleans, Louisiana. The next major port upriver is Louisiana's capital, Baton Rouge. A variety of other important ports exist in states farther upriver.

Many decades ago, the governor of Louisiana was a clever and controversial man named Huey Long. Legend has it that Long ordered that a bridge being constructed over the Mississippi River in Baton Rouge be built intentionally low to the ground. This ploy created a captive market for cargo because very large barges simply could not fit under the bridge. Large barges using the Mississippi River thus needed to unload their cargo in either New Orleans or Baton Rouge. Either way, Louisiana would benefit. Of course, owners of ports located farther up the river were not happy.

Ploys can be especially beneficial in the face of much stronger opponents. Military history offers quite a few illustrative examples. Before the American Revolution, land battles were usually fought by two opposing armies, each of which wore brightly colored clothing, marching toward each other across open fields. George Washington and his officers knew that the United States could not possibly defeat better-trained and better-equipped British forces in a traditional battle. To overcome its weaknesses, the American military relied on ambushes, hit-and-run attacks, and other guerilla moves. It even broke an unwritten rule of war by targeting British officers during skirmishes. This was an effort to reduce the opponent's effectiveness by removing its leadership.

Centuries earlier, the Carthaginian general Hannibal concocted perhaps the most famous ploy ever.



Hannibal's clever use of elephants to cross the Alps provides an example of a strategic ploy.

[Wikipedia](#) – public domain.

Carthage was at war with Rome, a scary circumstance for most Carthaginians given their far weaker fighting force. The Alps had never been crossed by an army. In fact, the Alps were considered such a treacherous mountain range that the Romans did not bother monitoring the part of their territory that bordered the Alps. No horse was up to the challenge, but Hannibal cleverly put his soldiers on elephants, and his army was able to make the mountain crossing. The Romans were caught completely unprepared and most of them were frightened by the sight of charging elephants. By using the element of surprise, Hannibal was able to lead his army to victory over a much more powerful enemy.

Ploys continue to be important today. In 2011, a pizzeria owner in Pennsylvania was accused of making a rather unique attempt to outmaneuver two rival pizza shops. According to police, the man tried to sabotage his competitors by placing mice in their pizzerias. If the ploy had not been discovered, the two shops could have suffered bad publicity or even been shut down by authorities because of health concerns. Although most strategic ploys are legal, this one was not, and the perpetrator was arrested (Reuters, 2011).

Strategy as a Pattern

[Strategy as pattern](#) is a third way to view strategy. This view focuses on the extent to which a firm's actions over time are consistent. A lack of a strategic pattern helps explain why Kmart deteriorated into bankruptcy in 2002. The company was started in the late nineteenth century as a discount department store. By the middle of the twentieth century, consistently working to be good at discount retailing had led Kmart to become a large and prominent chain.

By the 1980s, however, Kmart began straying from its established strategic pattern. Executives shifted the firm's focus away from discount retailing and toward diversification. Kmart acquired large stakes in chains involved in sporting goods (Sports Authority), building supplies (Builders Square), office supplies (OfficeMax), and books (Borders). In the 1990s, a new team of executives shifted Kmart's strategy again. Brands other than Kmart were sold off, and Kmart's strategy was adjusted to emphasize information technology and supply chain management. The next team of executives decided that Kmart's strategy would be to compete directly with its much-larger rival, Walmart. The resulting price war left Kmart crippled. Indeed, this last shift in strategy was the fatal mistake that drove Kmart into bankruptcy. Today, Kmart is part of Sears Holding Company, and its prospects remain uncertain.

In contrast, Apple is very consistent in its strategic pattern: It always responds to competitive challenges by innovating. Some of these innovations are complete busts. Perhaps the best known was the Newton, a tablet-like device that may have been ahead of its time. Another was the Pippin, a video game system introduced in 1996 to near-universal derision. Apple TV, a 2007 offering intended to link televisions with the Internet, also failed to attract customers. Such failures do not discourage Apple, however, and enough of its innovations are successful that Apple's overall performance is excellent. However, there are risks to following a pattern too closely. A consistent pattern can make a company predictable, a possibility that Apple must guard against in the years ahead.

Strategy as a Position

Viewing strategy as a plan, a ploy, and a pattern involve only the actions of a single firm. In contrast, the next P—[strategy as position](#)—considers a firm and its competitors. Specifically, strategy as position refers to a firm's place in the industry relative to its competitors. McDonald's, for example, has long been and remains the clear leader among fast-food chains. This position offers both good and bad aspects for McDonald's. One advantage of leading an industry is that many customers are familiar with and loyal to leaders. Being the market leader, however, also makes McDonald's a target for rivals such as Burger King and Wendy's. These firms create their strategies with McDonald's as a primary concern. Old Navy offers another example of strategy as position. Old Navy has been positioned to sell fashionable clothes at competitive prices.



Old Navy occupies a unique position as the low-cost strategy within the Gap Inc.'s fleet of brands.

Lindsey Turner – [clearance](#) – CC BY 2.0.

Old Navy is owned by the same corporation (Gap Inc.) as the midlevel brand the Gap and upscale brand Banana Republic. Each of these three brands is positioned at a different pricing level. The firm hopes that as Old Navy's customers grow older and more affluent, they will shop at the Gap and then eventually at Banana Republic. A similar positioning of different brands is pursued by General Motors through its Chevrolet (entry level), Buick (midlevel), and Cadillac (upscale) divisions.

Firms can carve out a position by performing certain activities in a different manner than their rivals. For example, Southwest Airlines is able to position itself as a lower-cost and more efficient provider by not offering meals that are common among other airlines. In addition, Southwest does not assign specific seats. This allows for faster loading of passengers. Positioning a firm in this manner can only be accomplished when managers make trade-offs that cut off certain possibilities (such as offering meals and assigned seats) to place their firms in a unique strategic space. When firms position themselves through unique goods and services customers value, business often thrives. But when firms try to please everyone, they often find themselves without the competitive positioning needed for long-term success. Thus deciding what a firm is not going to do is just as important to strategy as deciding what it is going to do (Porter, 1996).

To gain competitive advantage and greater success, firms sometimes change positions. But this can be a risky move. Winn-Dixie became a successful grocer by targeting moderate-income customers. When the firm abandoned this established position to compete for wealthier customers and higher margins, the results were disastrous. The firm was forced into bankruptcy and closed many stores. Winn-Dixie eventually exited bankruptcy, but like Kmart, its future prospects are unclear. In contrast to firms such as Winn-Dixie that change positions, Apple has long maintained a position as a leading innovator in various industries. This positioning has served Apple well.

Strategy as a Perspective

The fifth and final P shifts the focus to inside the minds of the executives running a firm. **Strategy as perspective** refers to how executives interpret the competitive landscape around them. Because each person is unique, two different executives could look at the same event—such as a new competitor emerging—and attach different meanings to it. One might just see a new threat to his or her firm’s sales; the other might view the newcomer as a potential ally.

An old cliché urges listeners to “make lemons into lemonade.” A good example of applying this idea through strategy as perspective is provided by local government leaders in Sioux City, Iowa. Rather than petition the federal government to change their airport’s unusual call sign—SUX—local leaders decided to leverage the call sign to attract the attention of businesses and tourists to build their city’s economic base. An array of clothing and other goods sporting the SUX name is available at <http://www.flysux.com>. Some strategists such as these local leaders are willing to take a seemingly sour situation and see the potential sweetness, while other executives remain fixated on the sourness.

Executives who adopt unique and positive perspectives can lead firms to find and exploit opportunities that others simply miss. In the mid-1990s, the Internet was mainly a communication tool for academics and government agencies. Jeff Bezos looked beyond these functions and viewed the Internet as a potential sales channel. After examining a number of different markets that he might enter using the Internet, Bezos saw strong profit potential in the bookselling business, and he began selling books online. Today, the company he created—Amazon—has expanded far beyond its original focus on books to become a dominant retailer in countless different markets. The late Steve Jobs at Apple appeared to take a similar perspective; he saw opportunities where others could not, and his firm has reaped significant benefits as a result.

Key Takeaway

- Strategic management focuses on firms and the different strategies that they use to become and remain successful. Multiple views of strategy exist, and the 5 Ps described by Henry Mintzberg enhance understanding of the various ways in which firms conceptualize strategy.

Exercises

1. Have you developed a strategy to manage your career? Should you make it more detailed? Why or why not?
2. Identify an example of each of the 5 Ps of strategy other than the examples offered in this section.
3. What business that you visit regularly seems to have the most successful business model? What makes the business model work?

References

- Markoff, J. 1996, May 14. Apple unveils strategic plan of small steps. *New York Times*. Retrieved from <http://www.nytimes.com/1996/05/14/business/apple-unveils-strategic-plan-of-small-steps.html>.
- Mintzberg, H. 1987. The strategy concept I: Five Ps for strategy. *California Management Review*, 30(1), 11–24.
- Porter, M. E. 1996, November–December. What is strategy? *Harvard Business Review*, 61–79.

Reuters. 2011, March 1. Philadelphia area pizza owner used mice vs. competition—police. Retrieved from news.yahoo.com/s/nm/20110301/od_uk_nm/oukoe_uk_crime_pizza.

1.3 Intended, Emergent, and Realized Strategies

Learning Objectives

1. Learn what is meant by intended and emergent strategies and the differences between them.
2. Understand realized strategies and how they are influenced by intended, deliberate, and emergent strategies.

A few years ago, a consultant posed a question to thousands of executives: “Is your industry facing overcapacity and fierce price competition?” All but one said “yes.” The only “no” came from the manager of a unique operation—the Panama Canal! This manager was fortunate to be in charge of a venture whose services are desperately needed by shipping companies and that offers the only simple route linking the Atlantic and Pacific Oceans. The canal’s success could be threatened if transoceanic shipping was to cease or if a new canal were built. Both of these possibilities are extremely remote, however, so the Panama Canal appears to be guaranteed to have many customers for as long as anyone can see into the future.

When an organization’s environment is stable and predictable, strategic planning can provide enough of a strategy for the organization to gain and maintain success. The executives leading the organization can simply create a plan and execute it, and they can be confident that their plan will not be undermined by changes over time. But as the consultant’s experience shows, only a few executives—such as the manager of the Panama Canal—enjoy a stable and predictable situation. Because change affects the strategies of almost all organizations, understanding the concepts of intended, emergent, and realized strategies is important (Table 1.2 “Strategic Planning and Learning: Intended, Emergent, and Realized Strategies”). Also relevant are deliberate and nonrealized strategies. The relationships among these five concepts are presented in Figure 1.3 “A Model of Intended, Deliberate, and Realized Strategy” (Mintzberg & Waters, 1985).

Table 1.2 Strategic Planning and Learning: Intended, Emergent, and Realized Strategies

Intended Strategy	Emergent Strategy	Realized Strategy
David McConnell aspired to be a writer. When his books weren't selling he decided to give out perfume as a gimmick.	The perfumes McConnell gave out with his books were popular, inspiring the foundation of the California Perfume Company.	The company changed its name to Avon in 1939, and its direct marketing system remained popular for decades. Avon is now available online and in retail outlets worldwide.
When father and son team Scott and Don Rasmussen were fired from the New England Whalers, they envisioned a cable television network that focused on sports events in the state of Connecticut.	As the network became successful, ESPN has branched out beyond the local softball games and demolition derbies that were first broadcasted.	ESPN is now billed as the worldwide leader in sports, owning several ESPN affiliates as well as production of ESPN magazine, ESPN radio, and broadcasting for ABC.
In 1977, a cash-strapped advertiser gave a radio station managed by Lowell Paxson 112 electric can openers to pay off an overdue bill. The can openers were offerend over the air for \$9.95 and quickly sold out.	An idea emerged. Soon the radio station featured a regular show called "Suncoast Bargaineers." In 1982, Paxson and a partner launched the Home Shopping Club on local cable television in Florida.	Today the Home Shopping Network has evolved into a retail powerhours. The company sells tens of thousands of products on television channels in several countries and over the internet.

Intended and Emergent Strategies

Figure 1.3 A Model of Intended, Deliberate, and Realized Strategy

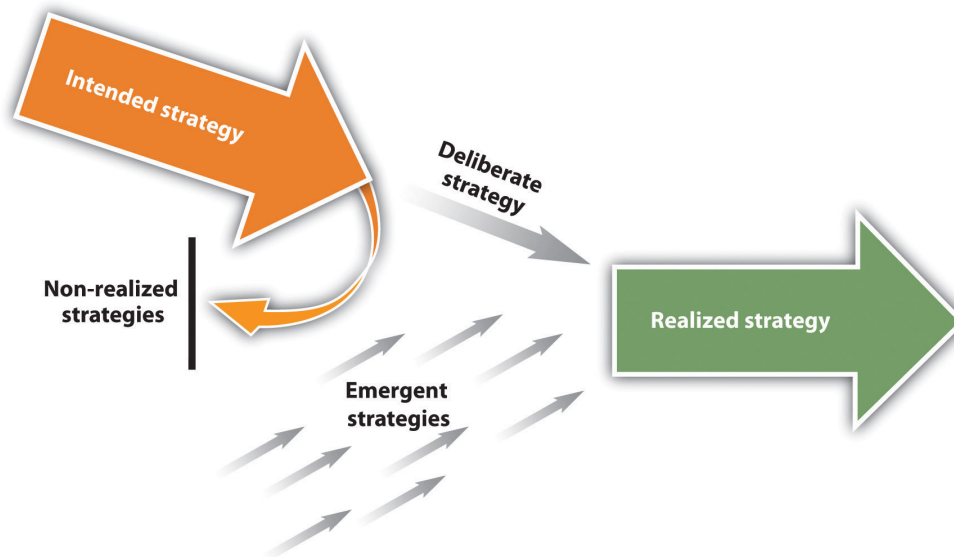

An **intended strategy** is the strategy that an organization hopes to execute. Intended strategies are usually described in detail within an organization's strategic plan. When a strategic plan is created for a new venture, it is called a business plan. As an undergraduate student at Yale in 1965, Frederick Smith had to complete a business plan for a proposed company as a class project. His plan described a delivery system that would gain efficiency by routing packages through a central hub and then pass them to their destinations. A few years later, Smith started Federal Express (FedEx), a company whose strategy closely followed the plan laid out in his class project. Today, Frederick Smith's personal wealth has surpassed \$2 billion, and FedEx ranks eighth among the World's Most Admired Companies according to *Fortune* magazine. Certainly, Smith's intended strategy has worked out far better than even he could have dreamed (Donahoe, 2011; Memphis Business Journal, 2011).

Emergent strategy has also played a role at Federal Express. An **emergent strategy** is an unplanned strategy that arises in response to unexpected opportunities and challenges. Sometimes emergent strategies result in disasters. In the mid-1980s, FedEx deviated from its intended strategy's focus on package delivery to capitalize on an emerging technology: facsimile (fax) machines. The firm developed a service called ZapMail that involved documents being sent electronically via fax machines between FedEx offices and then being delivered to customers' offices. FedEx executives hoped that ZapMail would be a success because it reduced the delivery time of a document from overnight to just a couple of hours. Unfortunately, however, the ZapMail system had many technical problems that frustrated customers. Even worse, FedEx failed to anticipate that many businesses would simply purchase their own fax machines. ZapMail was shut down before long, and FedEx lost hundreds of millions of dollars following its failed emergent strategy. In retrospect, FedEx had made a costly mistake by venturing outside of the domain that was central to its intended strategy: package delivery (Funding Universe).

Emergent strategies can also lead to tremendous success. Southern Bloomer Manufacturing Company was founded to make underwear for use in prisons and mental hospitals. Many managers of such institutions believe that the underwear made for retail markets by companies such as Calvin Klein and Hanes is simply not suitable for the people under their care. Instead, underwear issued to prisoners needs to be sturdy and durable to withstand the rigors of prison activities and laundering. To meet these needs, Southern Bloomers began selling underwear made of heavy cotton fabric.

An unexpected opportunity led Southern Bloomer to go beyond its intended strategy of serving institutional needs for durable underwear. Just a few years after opening, Southern Bloomer's performance was excellent. It was servicing the needs of about 125 facilities, but unfortunately, this was creating a vast amount of scrap fabric. An attempt to use the scrap as stuffing for pillows had failed, so the scrap was being sent to landfills. This was not only wasteful but also costly.

One day, cofounder Don Sonner visited a gun shop with his son. Sonner had no interest in guns, but he quickly spotted a potential use for his scrap fabric during this visit. The patches that the gun shop sold to clean the inside of gun barrels were of poor quality. According to Sonner, when he "saw one of those flimsy woven patches they sold that unraveled when you touched them, I said, 'Man, that's what I can do'" with the scrap fabric. Unlike other gun-cleaning patches, the patches that Southern Bloomer sold did not give off threads or lint, two by-products that hurt guns' accuracy and reliability. The patches quickly became popular with the military, police departments, and individual gun enthusiasts. Before long, Southern Bloomer was selling thousands of pounds of patches per month. A casual trip to a gun store unexpectedly gave rise to a lucrative emergent strategy (Wells, 2002).

Realized Strategy

A **realized strategy** is the strategy that an organization actually follows. Realized strategies are a product of a firm's intended strategy (i.e., what the firm planned to do), the firm's **deliberate strategy** (i.e., the parts of the intended strategy that the firm continues to pursue over time), and its emergent strategy (i.e., what the firm did in reaction to unexpected opportunities and challenges). In the case of FedEx, the intended strategy devised by its founder many years ago—fast package delivery via a centralized hub—remains a primary driver of the firm's realized strategy. For Southern Bloomers Manufacturing Company, realized strategy has been shaped greatly by both its intended and emergent strategies, which center on underwear and gun-cleaning patches.

In other cases, firms' original intended strategies are long forgotten. A **nonrealized strategy** refers to the abandoned

parts of the intended strategy. When aspiring author David McConnell was struggling to sell his books, he decided to offer complimentary perfume as a sales gimmick. McConnell's books never did escape the stench of failure, but his perfumes soon took on the sweet smell of success. The California Perfume Company was formed to market the perfumes; this firm evolved into the personal care products juggernaut known today as Avon. For McConnell, his dream to be a successful writer was a nonrealized strategy, but through Avon, a successful realized strategy was driven almost entirely by opportunistically capitalizing on change through emergent strategy.

Strategy at the Movies

The Social Network

Did Harvard University student Mark Zuckerberg set out to build a billion-dollar company with more than six hundred million active users? Not hardly. As shown in 2010's *The Social Network*, Zuckerberg's original concept in 2003 had a dark nature. After being dumped by his girlfriend, a bitter Zuckerberg created a website called "FaceMash" where the attractiveness of young women could be voted on. This evolved first into an online social network called Thefacebook that was for Harvard students only. When the network became surprisingly popular, it then morphed into Facebook, a website open to everyone. Facebook is so pervasive today that it has changed the way we speak, such as the word *friend* being used as a verb. Ironically, Facebook's emphasis on connecting with existing and new friends is about as different as it could be from Zuckerberg's original mean-spirited concept. Certainly, Zuckerberg's emergent and realized strategies turned out to be far nobler than the intended strategy that began his adventure in entrepreneurship.



The Social Network demonstrates how founder Mark Zuckerberg's intended strategy gave way to an emergent strategy via the creation of Facebook.

Robert Scoble – [Facebook Press Conference](#) – CC BY 2.0.

Key Takeaway

- Most organizations create intended strategies that they hope to follow to be successful. Over time, however, changes in an organization's situation give rise to new opportunities and challenges. Organizations respond to these changes using emergent strategies. Realized strategies are a product of both intended and realized strategies.

Exercises

1. What is the difference between an intended and an emergent strategy?
2. Can you think of a company that seems to have abandoned its intended strategy? Why do you suspect it was abandoned?
3. Would you describe your career strategy in college to be more deliberate or emergent? Why?

References

- Donahoe, J. A. 2011, March 10. *Forbes*: Fred Smith's fortune grows to \$.21B. *Memphis Business Journal*. Retrieved from <http://www.bizjournals.com/memphis/news/2011/03/10/forbes-fred-smiths-fortune-grows-to.html>.
- Funding Universe. FedEx Corporation. Retrieved from <http://www.fundinguniverse.com/company-histories/FedEx-Corporation-Company-History.html>.
- Memphis Business Journal. Retrieved from <http://www.bizjournals.com/memphis/news/2011/03/03/fortune-fedex-8th-most-admired.html>.
- Mintzberg, H., & Waters, J. A. 1985. Of strategies, deliberate and emergent. *Strategic Management Journal*, 6, 257–272.
- Wells, K. 2002. *Floating off the page: The best stories from the Wall Street Journal's middle column*. New York: Simon & Shuster. Quote from page 97.

1.4 The History of Strategic Management

Learning Objectives

1. Consider how strategy in ancient times and military strategy can provide insights to businesses.
2. Describe how strategic management has evolved into a field of study.

Those who cannot remember the past are condemned to repeat it.

George Santayana, *The Life of Reason*

Santayana's quote has strong implications for strategic management. The history of strategic management can be traced back several thousand years. Great wisdom about strategy can be acquired by understanding the past, but ignoring the lessons of history can lead to costly strategic mistakes that could have been avoided. Certainly, the present offers very important lessons; businesses can gain knowledge about what strategies do and do not work by studying the current actions of other businesses. But this section discusses two less obvious sources of wisdom: (1) strategy in ancient times and (2) military strategy. This section also briefly traces the development of strategic management as a field of study.

Table 1.4 Strategy in Ancient Times

Strategic management borrows many ideas from ancient uses of strategy over time. The following anecdotes provide a few notable examples of historical actions that remain relevant for the study of modern strategy. Indeed, the Greek verb strategos means "army leader" and the idea of stratego (from which we get the word strategy) refers to the idea of destroying one's enemies through the effective use of resources.

1491 BC: Moses uses hierarchical delegation of authority during the exodus from Egypt. Dividing a large set of people into smaller groups creates a command structure that enables strategies to be implemented.

500 BC: Sun Tzu's *The Art of War* provides a classic handbook on military strategy with numerous business applications, such as the idea "to win without fighting is the best." This type of approach was used by businesses, such as Gap Inc. when they decided to create their own stores rather than competing for shelf space for their clothing within traditional department stores.

70 BC: Roman poet Virgil tells the story of the Trojan horse, a classic strategic ploy where the Greek forces hid a select number of soldiers in a large wooden horse that the Trojan army took into their heavily guarded city gates. Once inside the city, Greek soldiers were able to open the gates and allow in reinforcements which eventually led to the end of the war.

c. 530: King Arthur rules Britain. Legend says he made his famed round table so that no one, including him, would be seen as above the others. His mission to find the Holy Grail serves as an exemplar for the importance of the central mission to guide organizational actions.

Strategy in Ancient Times

Perhaps the earliest-known discussion of strategy is offered in the Old Testament of the Bible (Bracker, 1980). Approximately 3,500 years ago, Moses faced quite a challenge after leading his fellow Hebrews out of enslavement in Egypt. Moses was overwhelmed as the lone strategist at the helm of a nation that may have exceeded one million people. Based on advice from his father-in-law, Moses began delegating authority to other leaders, each of whom oversaw a group of people. This hierarchical delegation of authority created a command structure that freed Moses to concentrate on the biggest decisions and helped him implement his strategies (Table 1.4 "Strategy in Ancient Times"). Similarly, the demands of strategic management today are simply too much for a chief executive officer (the top leader of a company) to handle alone. Many important tasks are thus entrusted to vice presidents and other executives.

In ancient China, strategist and philosopher Sun Tzu offered thoughts on strategy that continue to be studied carefully by business and military leaders today. Sun Tzu's best-known work is *The Art of War*. As this title implies, Sun Tzu emphasized the creative and deceptive aspects of strategy.

One of Sun Tzu's ideas that has numerous business applications is that winning a battle without fighting is the best way to win. Apple's behavior in the personal computer business offers a good example of this idea in action. Many computer makers such as Toshiba, Acer, and Lenovo compete with one another based primarily on price. This leads to price wars that undermine the computer makers' profits. In contrast, Apple prefers to develop unique features for its computers, features that have created a fiercely loyal set of customers. Apple boldly charges far more for its computers than its rivals charge for theirs. Apple does not even worry much about whether its computers' software is compatible with the software used by most other computers. Rather than fighting a battle with other firms, Apple wins within the computer business by creating its own unique market and by attracting a set of loyal customers. Sun Tzu would probably admire Apple's approach.

Perhaps the most famous example of strategy in ancient times revolves around the Trojan horse. According to legend, Greek soldiers wanted to find a way to enter the gates of Troy and attack the city from the inside. They devised a ploy that involved creating a giant wooden horse, hiding soldiers inside the horse, and offering the horse to the Trojans as a gift. The Trojans were fooled and brought the horse inside their city. When night arrived, the hidden Greek soldiers opened the gates for their army, leading to a Greek victory. In modern times, the term *Trojan horse* refers to gestures

that appear on the surface to be beneficial to the recipient but that mask a sinister intent. Computer viruses also are sometimes referred to as Trojan horses.

A far more noble approach to strategy than the Greeks' is attributed to King Arthur of Britain. Unlike the hierarchical approach to organizing Moses used, Arthur allegedly considered himself and each of his knights to have an equal say in plotting the group's strategy. Indeed, the group is thought to have held its meetings at a round table so that no voice, including Arthur's, would be seen as more important than the others. The choice of furniture in modern executive suites is perhaps revealing. Most feature rectangular meeting tables, perhaps signaling that one person—the chief executive officer—is in charge.

Another implication for strategic management offered by King Arthur and his Knights of the Round Table involves the concept of mission. Their vigorous search to find the Holy Grail (the legendary cup used by Jesus and his disciples at the Last Supper) serves as an exemplar for the importance of a central mission to guide organizational strategy and actions.

Lessons Offered by Military Strategy

Key military conflicts and events have shaped the understanding of strategic management (Table 1.5 “Classic Military Strategy”). Indeed, the word *strategy* has its roots in warfare. The Greek verb *strategos* means “army leader” and the idea of *stratego* (from which we get the word *strategy*) refers to defeating an enemy by effectively using resources (Bracker, 1980).

A book written nearly five hundred years ago is still regarded by many as an insightful guide for conquering and ruling territories. Niccolò Machiavelli's 1532 book *The Prince* offers clever recipes for success to government leaders. Some of the book's suggestions are quite devious, and the word *Machiavellian* is used today to refer to acts of deceit and manipulation.

Two wars fought on American soil provide important lessons about strategic management. In the late 1700s, the American Revolution pitted the American colonies against mighty Great Britain. The Americans relied on nontraditional tactics, such as guerilla warfare and the strategic targeting of British officers. Although these tactics were considered by Great Britain to be barbaric, they later became widely used approaches to warfare. The Americans owed their success in part to help from the French navy, illustrating the potential value of strategic alliances.

Nearly a century later, Americans turned on one another during the Civil War. After four years of hostilities, the Confederate states were forced to surrender. Historians consider the Confederacy to have had better generals, but the Union possessed greater resources, such as factories and railroad lines. As many modern companies have discovered, sometimes good strategies simply cannot overcome a stronger adversary.

Two wars fought on Russian soil also offer insights. In the 1800s, a powerful French invasion force was defeated in part by the brutal nature of Russian winters. In the 1940s, a similar fate befell German forces during World War II. Against the advice of some of his leading generals, Adolf Hitler ordered his army to conquer Russia. Like the French before them, the Germans were able to penetrate deep into Russian territory. As George Santayana had warned, however, the forgotten past was about to repeat itself. Horrific cold stopped the German advance. Russian forces eventually took control of the combat, and Hitler committed suicide as the Russians approached the German capital, Berlin.

Five years earlier, Germany ironically had benefited from an opponent ignoring the strategic management lessons of the past. In ancient times, the Romans had assumed that no army could cross a mountain range known as the Alps. An enemy general named Hannibal put his men on elephants, crossed the mountains, and caught Roman forces unprepared. French commanders made a similar bad assumption in 1940. When Germany invaded Belgium (and then France) in 1940, its strategy caught French forces by surprise.

The top French commanders assumed that German tanks simply could not make it through a thickly wooded region known as the Ardennes Forest. As a result, French forces did not bother preparing a strong defense in that area. Most of the French army and their British allies instead protected against a small, diversionary force that the Germans had sent as a deception to the north of the forest. German forces made it through the forest, encircled the allied forces,

and started driving them toward the ocean. Many thousands of French and British soldiers were killed or captured. In retrospect, the French generals had ignored an important lesson of history: Do not make assumptions about what your adversary can and cannot do. Executives who make similar assumptions about their competitors put their organizations' performance in jeopardy.

Table 1.5 Classic Military Strategy

Strategic management often borrows lessons as well as metaphors from classic military strategy. For example, major business decisions are often categorized as “strategic” while more minor decisions (such as small changes in price or the opening of a new location) are referred to as “tactical” decisions. Here are a few select examples of classic military strategies that hold insights for strategic decisions today.

1532: Machiavelli's book *The Prince* offers clever recipes for success to government leaders. Some of the book's suggestions are quite devious, and the word *Machiavellian* comes to refer to acts of deceit and manipulation.

1775: The American Revolutionary War between the United States and Great Britain begins. Weaker American forces win the war in part by relying on nontraditional tactics such as guerilla warfare and the strategic targeting of British officers. They also depend on help from the French navy, illustrating the potential value of strategic alliances.

1815: Napoleon's defeat at Waterloo demonstrates how spreading resources too thin can result in defeat of even one of the most famed militaries of all time.

1865: The American Civil War ends. Historians consider the Confederacy to have had better generals, but the Union possessed greater resources. Sometimes good strategies simply cannot overcome a stronger adversary.

1944: Following a series of deceptions designed to confuse and fool German forces, the Allies launch the D-Day invasion in an effort to liberate Europe from Nazi control.

Strategic Management as a Field of Study

Universities contain many different fields of study, including physics, literature, chemistry, computer science, and engineering. Some fields of study date back many centuries (e.g., literature), while others (such as computer science) have emerged only in recent years. Strategic management has been important throughout history, but the evolution of strategic management into a field of study has mostly taken place over the past century. A few of the key business and academic events that have helped the field develop are discussed next.

The ancient Chinese strategist Sun Tzu made it clear that strategic management is part art. But it is also part science. Major steps toward developing the scientific aspect of strategic management were taken in the early twentieth century by Frederick W. Taylor. In 1911, Taylor published *The Principles of Scientific Management*. The book was a response to Taylor's observation that most tasks within organizations were organized haphazardly. Taylor believed that businesses would be much more efficient if management principles were derived through scientific investigation. In *The Principles of Scientific Management*, Taylor stressed how organizations could become more efficient through identifying the “one best way” of performing important tasks. Implementing Taylor's principles was thought to have saved railroad companies hundreds of millions of dollars. Although many later works disputed the merits of trying to find the “one best way,” Taylor's emphasis on maximizing organizational performance became the core concern of strategic management as the field developed.

Also in the early twentieth century, automobile maker Henry Ford emerged as one of the pioneers of strategic management among industrial leaders. At the time, cars seemed to be a luxury item for wealthy people. Ford adopted a unique strategic perspective, however, and boldly offered the vision that he would make cars the average family could afford. Building on ideas about efficiency from Taylor and others, Ford organized assembly lines for creating automobiles that lowered costs dramatically. Despite his wisdom, Ford also made mistakes. Regarding his company's flagship product, the Model T, Ford famously stated, "Any customer can have a car painted any color that he wants so long as it is black." When rival automakers provided customers with a variety of color choices, Ford had no choice but to do the same.

In 1912, Harvard University became the first higher education institution to offer a course focused on how business executives could lead their organizations to greater success. The approach to maximizing performance within this "business policy" course was consistent with Taylor's ideas. Specifically, the goal of the business policy course was to identify the one best response to any given problem that an organization confronted. By finding and pursuing this ideal solution, the organization would have the best chance of enjoying success.

In the 1920s, A&W Root Beer became the first franchised restaurant chain. **Franchising** involves an organization (called a franchisor) granting the right to use its brand name, products, and processes to other organizations (known as franchisees) in exchange for an up-front payment (a franchise fee) and a percentage of franchisees' revenues (a royalty fee). This simple yet powerful business model allows franchisors to grow their brands rapidly and provides franchisees with the safety of a proven business format. Within a few decades, the franchising business model would fuel incredible successes for many franchisors and franchisees across a variety of industries. Today, for example, both Subway and McDonald's have more than thirty thousand restaurants carrying their brand names.

The acceptance of strategic management as a necessary element of business school programs took a major step forward in 1959. A widely circulated report created by the Ford Foundation recommended that all business schools offer a "capstone" course. The goal of this course would be to integrate knowledge across different business fields such as marketing, finance, and accounting to help students devise better ideas for addressing complex business problems. Rather than seeking a "one best way" solution, as advocated by Taylor and Harvard's business policy course, this capstone course would emphasize students' critical thinking skills in general and the notion that multiple ways of addressing a problem could be equally successful in particular. The Ford Foundation report was a key motivator that led US universities to create strategic management courses in their undergraduate and master of business administration programs.

In 1962, business and academic events occurred that seemed minor at the time but that would later give rise to huge changes. Building on the business savvy that he had gained as a franchisee, Sam Walton opened the first Walmart in Rogers, Arkansas. Relying on a strategy that emphasized low prices and high levels of customer service, Walmart grew to 882 stores with a combined \$8.4 billion dollars in annual sales by 1985. A decade later, sales reached \$93.6 billion across nearly 3,000 stores. In 2010, Walmart was the largest company in the world. In recent years, Walmart has arguably downplayed customer service in favor of cutting costs. Time will tell whether deviating from Sam Walton's original strategic positioning will hurt the company.

Also in 1962, Harvard professor Alfred Chandler published *Strategy and Structure: Chapters in the History of the Industrial Enterprise*. This book describes how strategy and organizational structure need to be consistent with each other to ensure strong firm performance, a lesson that Moses seems to have mastered during the Hebrews' exodus from Egypt. Many people working in the field of strategic management consider Chandler's book to be the first work of strategic management research.

Two pivotal events that firmly established strategic management as a field of study took place in 1980. One was the creation of the *Strategic Management Journal*. The introduction of the journal offered a forum for researchers interested in building knowledge about strategic management. Much like important new medical findings appear in the *Journal of the American Medical Association* and the *New England Journal of Medicine*, the *Strategic Management Journal* publishes pathbreaking insights about strategic management.

The second pivotal event in 1980 was the publication of *Competitive Strategy: Techniques for Analyzing Industries and Competitors* by Harvard professor Michael Porter. This book offers concepts such as five forces analysis and generic

strategies that continue to strongly influence how executives choose strategies more than thirty years after the book's publication. Given the importance of these concepts, both five forces analysis and generic strategies are discussed in detail in [Chapter 3 "Evaluating the External Environment"](#) and [Chapter 5 "Selecting Business-Level Strategies"](#), respectively.

Intended and Emergent Strategies

Figure 1.3 A Model of Intended, Deliberate, and Realized Strategy

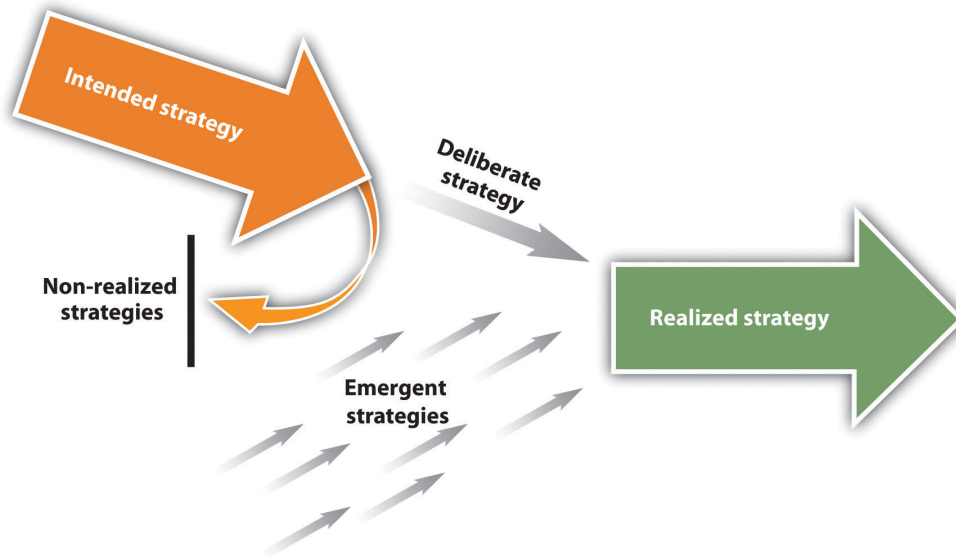

Table 1.6 The Modern History of Strategic Management

Although strategy has been important throughout history, strategic management as a field of study has largely developed over the past century. Below are a few key business and academic events that have helped the field evolve.

Year	Notable event
1909	Ford first produces its classic Model T.
1911	Frederick W. Taylor publishes <i>The Principles of Scientific Management</i> .
1912	The precursor to the modern strategic management course was created at Harvard Business School under the title of “business policy.”
1925	A&W Root Beer becomes America’s first franchised restaurant chain.
1959	The Ford Foundation recommends that business school curricula include a ‘capstone’ course that integrates knowledge across business fields in order to help solve complex business problems.
1962	Alfred Chandler published <i>Strategy and Structure: Chapters in the History of the Industrial Enterprise</i> .
1962	Sam Walton opens the first Wal-Mart in Arkansas. Relying on a strategy that emphasized low prices and high levels of customer service.
1980	The <i>Strategic Management Journal</i> is created.
1995	The launch of Amazon.com by founder Jeff Bezos is perhaps the pivotal event in creating Internet-based commerce.
2001	Enron Corporation declares bankruptcy after a series of disclosures reveal that the firm’s stellar performance had been a product of fraud and corruption.
2005	Thomas Friedman’s book <i>The World is Flat: A Brief History of the Twenty-First Century</i> suggests that many advantages that firms in developed countries like the United States take for granted are disappearing.
2010	Wal-Mart becomes the largest company in the world.

Many consumers today take web-based shopping for granted, but this channel for commerce was created less than two decades ago. The 1995 launch of Amazon by founder Jeff Bezos was perhaps the pivotal event in creating Internet-based commerce. In pursuit of its vision “to be earth’s most customer-centric company,” Amazon has diversified far beyond its original focus on selling books and has evolved into a dominant retailer. Powerful giants have stumbled badly in Amazon’s wake. Sears had sold great varieties of goods (even including entire houses) through catalogs for many decades, as had JCPenney. Neither firm created a strong online sales presence to keep pace with Amazon, and both eventually dropped their catalog businesses. As often happens with old and large firms, Sears and JCPenney were outmaneuvered by a creative and versatile upstart.

Ethics have long been an important issue within the strategic management field. Attention to the need for executives to act ethically when creating strategies increased dramatically in the early 2000s when a series of companies such as Enron Corporation, WorldCom, Tyco, Qwest, and Global Crossing were found to have grossly exaggerated the

strength of their performance. After a series of revelations about fraud and corruption, investors in these firms and others lost billions of dollars, tens of thousands of jobs were lost, and some executives were sent to prison.

Like ethics, the implications of international competition are of central interest to strategic management. Provocative new thoughts on the nature of the international arena were offered in 2005 by Thomas L. Friedman. In his book *The World Is Flat: A Brief History of the Twenty-First Century*, Friedman argues that many of the advantages that firms in developed countries such as the United States, Japan, and Great Britain take for granted are disappearing. One implication is that these firms will need to improve their strategies if they are to remain successful.

Looking to the future, it appears likely that strategic management will prove to be more important than ever. In response, researchers who are interested in strategic management will work to build additional knowledge about how organizations can maximize their performance. Executives will need to keep track of the latest scientific findings. Meanwhile, they also must leverage the insights that history offers on how to be successful while trying to avoid history's mistakes.

Key Takeaway

- Although strategic management as a field of study has developed mostly over the last century, the concept of strategy is much older. Understanding strategic management can benefit greatly by learning the lessons that ancient history and military strategy provide.

Exercises

1. What do you think was the most important event related to strategy in ancient times?
2. In what ways are the strategic management of business and military strategy alike? In what ways are they different?
3. Do you think executives are more ethical today as a result of the scandals in the early 2000s? Why or why not?

References

Bracker, J. 1980. The historical development of the strategic management concept. *Academy of Management Review*, 5(2), 219–224.

1.5 Understanding the Strategic Management Process

Learning Objectives

1. Learn the strategic management process.
2. Understand the four steps in the strategic management process.

Modeling the Strategy Process

Strategic management is a process that involves building a careful understanding of how the world is changing, as well as a knowledge of how those changes might affect a particular firm. CEOs, such as late Apple-founder Steve Jobs, must be able to carefully manage the possible actions that their firms might take to deal with changes that occur in their environment. We present a model of the strategic management process in [Figure 1.7 “Overall Model of the Strategic Management Process”](#). This model also guides our presentation of the chapters contained in this book.

Figure 1.7 Overall Model of the Strategic Management Process
The Strategic Management Process

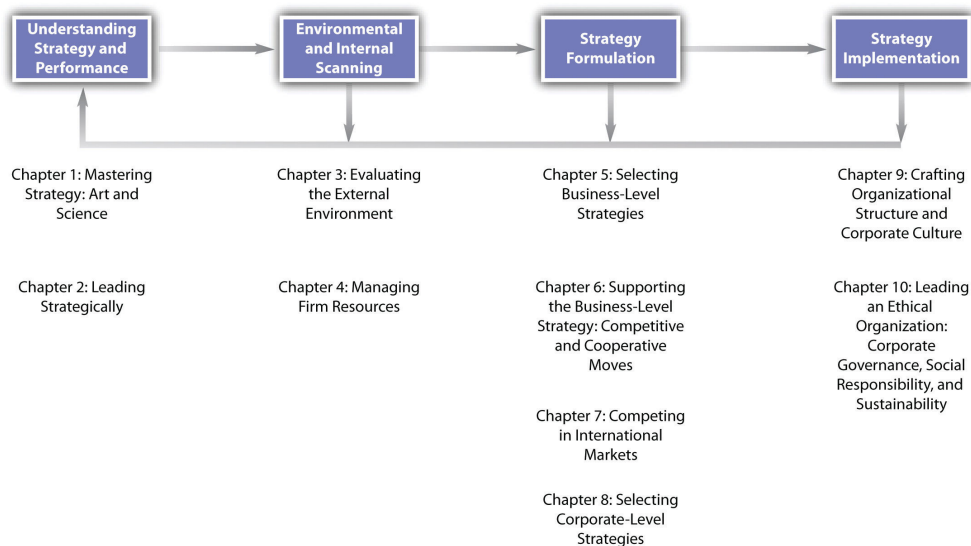

The strategic management process begins with an understanding of strategy and performance. As we have noted in this introductory chapter, strategic management is both an art and a science, and it involves multiple conceptualizations of the notion of strategy drawn from recent and ancient history. In [Chapter 2 “Leading Strategically”](#), we focus on how leading strategically is needed if the firm is to achieve the long-term strong performance companies such as Apple have attained. Consequently, how managers understand and interpret the performance of their firms is often central to understanding strategy.

Environmental and internal scanning is the next stage in the process. Managers must constantly scan the external environment for trends and events that affect the overall economy, and they must monitor changes in the particular industry in which the firm operates. For example, Apple’s decision to create the iPhone demonstrates its ability to interpret that traditional industry boundaries that distinguished the cellular phone industry and the computer industry were beginning to blur. At the same time, firms must evaluate their own resources to understand how they might react to changes in the environment. For example, intellectual property is a vital resource for Apple. Between 2008 and 2010, Apple filed more than 350 cases with the US Patent and Trademark Office to protect its use of such terms as *apple*, *pod*, and *safari* (Apple Inc.).

A classic management tool that incorporates the idea of scanning elements both external and internal to the firm is SWOT (strengths, weaknesses, opportunities, and threats) analysis. Strengths and weaknesses are assessed by examining the firm’s resources, while opportunities and threats refer to external events and trends. The value of SWOT analysis parallels ideas from classic military strategists such as Sun Tzu, who noted the value of knowing yourself as well as your opponent. [Chapter 3 “Evaluating the External Environment”](#) examines the topic of evaluating the external environment in detail, and [Chapter 4 “Managing Firm Resources”](#) presents concepts and tools for managing firm resources.



The importance of knowing yourself and your opponent is applicable to the knowledge of strategic management for business, military strategy, and classic strategy games such as chess.

Mamooli – [Chess](#) – CC BY-NC 2.0.

Strategy formulation is the next step in the strategic management process. This involves developing specific strategies and actions. Certainly, part of Apple’s success is due to the unique products it offers the market, as well as how these products complement one another. A customer can buy an iPod that plays music from iTunes—all of which can be stored in Apple’s Mac computer (Inside CRM Editors). In [Chapter 5 “Selecting Business-Level Strategies”](#), we discuss how selecting business-level strategies helps to provide firms with a recipe that can be followed that will increase the likelihood that their strategies will be successful. In [Chapter 6 “Supporting the Business-Level Strategy: Competitive and Cooperative Moves”](#), we present insights on how firms can support the business-level strategy through competitive and cooperative moves. [Chapter 7 “Competing in International Markets”](#) presents possibilities for firms competing

in international markets, and [Chapter 8 “Selecting Corporate-Level Strategies”](#) focuses on selecting corporate-level strategies.

Strategy implementation is the final stage of the process. One important element of strategy implementation entails crafting an effective organizational structure and corporate culture. For example, part of Apple’s success is due to its consistent focus on innovation and creativity that Steve Jobs described as similar to that of a start-up. [Chapter 9 “Executing Strategy through Organizational Design”](#) offers ideas on how to manage these elements of implementation. The final chapter explores how to lead an ethical organization through corporate governance, social responsibility, and sustainability.

Key Takeaway

- Strategic management is a process that requires the ability to manage change. Consequently, executives must be careful to monitor and to interpret the events in their environment, to take appropriate actions when change is needed, and to monitor their performance to ensure that their firms are able to survive and, it is hoped, thrive over time.

Exercises

1. Who makes the strategic decisions for most organizations?
2. Why is it important to view strategic management as a process?
3. What are the four steps of the strategic management process?
4. How is chess relevant to the study of strategic management? What other games might help teach strategic thinking?

References

Apple Inc. litigation. Wikipedia. Retrieved from en.wikipedia.org/wiki/Apple_Inc._litigation.

Inside CRM Editors. Effective strategies Apple uses to create loyal customers [Online article]. Retrieved from <http://www.insidecrm.com/features/strategies-apple-loyal-customers>.

1.6 Conclusion

This chapter provides an overview of strategic management and strategy. Ideas about strategy span many centuries, and modern understanding of strategy borrows from ancient strategies as well as classic military strategies. You should now understand that there are numerous ways to conceptualize the idea of strategy and that effective strategic management is needed to ensure the long-term success of firms. The study of strategic management provides tools to effectively manage organizations, but it also involves the art of knowing how and when to apply creative thinking. Knowledge of both the art and the science of strategic management is needed to help guide organizations as their strategies emerge and evolve over time. Such tools will also help you effectively chart a course for your career as well as to understand the effective strategic management of the organizations for which you will work.

Exercises

1. Think about the best and worst companies you know. What is extraordinary (or extraordinarily bad) about these firms? Are their strategies clear and focused or difficult to define?
2. If you were to write a “key takeaway” section for this chapter, what would you include as the material you found most interesting?

Chapter 2: Leading Strategically

Chapter 2: Leading Strategically

2.1 Leading Strategically

2.2 Vision, Mission, and Goals

2.3 Assessing Organizational Performance

2.4 The CEO as Celebrity

2.5 Entrepreneurial Orientation

2.6 Conclusion

2.1 Leading Strategically

Learning Objectives

After reading this chapter, you should be able to understand and articulate answers to the following questions:

1. What are vision, mission, and goals, and why are they important to organizations?
2. How should executives analyze the performance of their organizations?
3. In what ways can having a celebrity CEO and a strong entrepreneurial orientation help or harm an organization?

Questions Are Brewing at Starbucks



Starbucks's global empire includes this store in Seoul, South Korea.

[Wikimedia Commons](#) – public domain.

March 30, 2011, marked the fortieth anniversary of Starbucks first store opening for business in Seattle, Washington. From its humble beginnings, Starbucks grew to become the largest coffeehouse company in the world while stressing the importance of both financial and social goals. As it created thousands of stores across dozens of countries, the company navigated many interesting periods. The last few years were a particularly fascinating era.

In early 2007, Starbucks appeared to be very successful, and its stock was worth more than \$35 per share. By 2008, however, the economy was slowing, competition in the coffee business was heating up, and Starbucks's performance had become disappointing. In a stunning reversal of fortune, the firm's stock was worth less than \$10 per share by the end of the year. Anxious stockholders wondered whether Starbucks's decline would continue or whether the once high-flying company would return to its winning ways.

Riding to the rescue was Howard Schultz, the charismatic and visionary founder of Starbucks who had stepped down as chief executive officer eight years earlier. Schultz again took the helm and worked to turn the company around by emphasizing its mission statement: "to inspire and nurture the human spirit—one person, one cup and one neighborhood at a time (Starbucks)." About a thousand underperforming stores were shut down permanently. Thousands of other stores closed for a few hours so that baristas could be retrained to make inspiring drinks. Food offerings were revamped to ensure that coffee—not breakfast sandwiches—were the primary aroma that tantalized customers within Starbucks's outlets.

By the time Starbucks's fortieth anniversary arrived, Schultz had led his company to regain excellence, and its stock price was back above \$35 per share. In March 2011, Schultz summarized the situation by noting that "over the last three years, we've completely transformed the company, and the health of Starbucks is quite good. But I don't think this is a time to celebrate or run some victory lap. We've got a lot of work to do (Starbucks, 2011)." Indeed, important questions loomed. Could performance improve further? How long would Schultz remain with the company? Could Schultz's eventual successor maintain Schultz's entrepreneurial approach as well as keep Starbucks focused on its mission?

References

Starbucks, Our Starbucks mission statement. Retrieved from <http://www.starbucks.com/about-us/company-information/mission-statement>. Accessed March 31, 2011.

Starbucks, Onward: How Starbucks fought for its life without losing its soul by Howard Schultz]. 2011, March 28. NPR Books. Retrieved from <http://www.npr.org/2011/03/28/134738487/starbucks-ceo-can-you-get-big-and-stay-small>.

2.2 Vision, Mission, and Goals

Learning Objectives

1. Define vision and mission and distinguish between them.
2. Know what the acronym SMART represents.
3. Be able to write a SMART goal.

The Importance of Vision

“Good business leaders create a vision, articulate the vision, passionately own the vision, and relentlessly drive it to completion.”

–Jack Welch, former CEO of General Electric

Many skills and abilities separate effective strategic leaders like Howard Schultz from poor strategic leaders. One of them is the ability to inspire employees to work hard to improve their organization’s performance. Effective strategic leaders are able to convince employees to embrace lofty ambitions and move the organization forward. In contrast, poor strategic leaders struggle to rally their people and channel their collective energy in a positive direction.

As the quote from Jack Welch suggests, a **vision** is one key tool available to executives to inspire the people in an organization (Table 2.1 “The Big Picture: Organizational Vision”). An organization’s vision describes what the organization hopes to become in the future. Well-constructed visions clearly articulate an organization’s aspirations. Avon’s vision is “to be the company that best understands and satisfies the product, service, and self-fulfillment needs of women—globally.” This brief but powerful statement emphasizes several aims that are important to Avon, including excellence in customer service, empowering women, and the intent to be a worldwide player. Like all good visions, Avon sets a high standard for employees to work collectively toward. Perhaps no vision captures high standards better than that of aluminum maker Alcoa. This firm’s very ambitious vision is “to be the best company in the world—in the eyes of our customers, shareholders, communities and people.” By making clear their aspirations, Alcoa’s executives hope to inspire employees to act in ways that help the firm become the best in the world.

The results of a survey of one thousand five hundred executives illustrate how the need to create an inspiring vision creates a tremendous challenge for executives. When asked to identify the most important characteristics of effective strategic leaders, 98 percent of the executives listed “a strong sense of vision” first. Meanwhile, 90 percent of the executives expressed serious doubts about their own ability to create a vision (Quigley, 1994). Not surprisingly, many organizations do not have formal visions. Many organizations that do have visions find that employees do not embrace and pursue the visions. Having a well-formulated vision employees embrace can therefore give an organization an edge over its rivals.

Table 2.1 The Big Picture: Organizational Vision

An organization’s vision describes what the organization hopes to become in the future. Visions highlight the values and aspirations that lay at the heart of the organization. Although visions statements have the potential to inspire employees, customers,

and other stakeholders, vision statements are relatively rare and good visions are even rarer. Some of the visions being pursued by businesses today are offered below.

Company	Vision
Alcoa	To be the best company in the world—in the eyes of our customers, shareholders, communities and people.
Avon	To be the company that best understands and satisfies the product, service and self-fulfillment needs women—globally.
Chevron	To be the global energy company most admired for its people, partnership and performance.
Google	To develop a perfect search engine.
Kraft Foods	Helping people around the world eat and live better.
Proctor and Gamble	Be, and be recognized as, the best consumer products and services company in the world.

Mission Statements

In working to turnaround Starbucks, Howard Schultz sought to renew Starbucks's commitment to its **mission** statement: "to inspire and nurture the human spirit—one person, one cup and one neighborhood at a time." A mission such as Starbucks's states the reasons for an organization's existence. Well-written mission statements effectively capture an organization's identity and provide answers to the fundamental question "Who are we?" While a vision looks to the future, a mission captures the key elements of the organization's past and present (Table 2.2 "Missions").

Table 2.2 Missions

While a vision describes what an organization desires to become in the future, an organization's mission is grounded in the past and present. A mission outlines the reasons for the organization's existence and explains what role it plays in society. A well-written mission statement captures the organization's identity and helps to answer the fundamental question of "Who are we?" As a practical matter, a mission statement explains to key stakeholders why they should support the organization. The following examples illustrate the connections between organizations and the needs of their key stakeholders.

Company	Mission Statement
Harley Davidson	We ride with our customers and apply this deep connection in every market we serve to create superior value for all of our stakeholders.
Internal Revenue Service	Provide America’s taxpayers top-quality service by helping them understand and meet their tax responsibilities and enforce the law with integrity and fairness to all.
Starbucks	To inspire and nurture the human spirit – one person, one cup and one neighborhood at a time.
The Estée Lauder Company	Bringing the best to everyone we touch and being the best in everything we do.
Limited Brands	Limited Brands is committed to building a family of the world’s best fashion brands offering captivating customer experiences that drive long-term loyalty and deliver sustained growth for our shareholders.
Fender Musical Instruments	We will exceed the expectations of music enthusiasts worldwide and create a community for individual expression by focusing on our people, products, and business excellence.

Organizations need support from their key stakeholders, such as employees, owners, suppliers, and customers, if they are to prosper. A mission statement should explain to stakeholders why they should support the organization by making clear what important role or purpose the organization plays in society. Google’s mission, for example, is “to organize the world’s information and make it universally accessible and useful.” Google pursued this mission in its early days by developing a very popular Internet search engine. The firm continues to serve its mission through various strategic actions, including offering its Internet browser Google Chrome to the online community, providing free e-mail via its Gmail service, and making books available online for browsing.

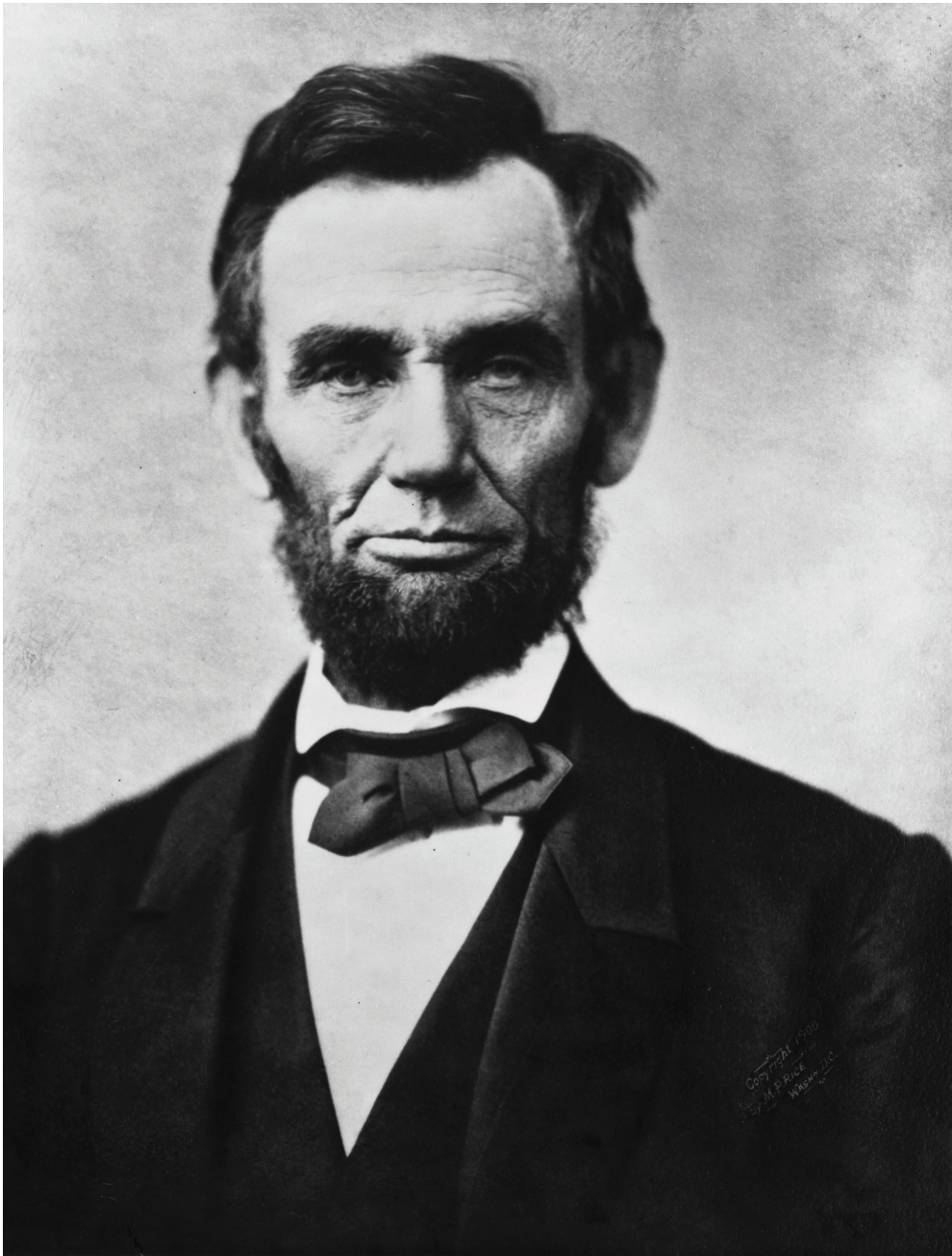

Many consider Abraham Lincoln to have been one of the greatest strategic leaders in modern history.

[Wikimedia Commons](#) – public domain.

One of Abraham Lincoln’s best-known statements is that “a house divided against itself cannot stand.” This provides a helpful way of thinking about the relationship between vision and mission. Executives ask for trouble if their organization’s vision and mission are divided by emphasizing different domains. Some universities have fallen into this trap. Many large public universities were established in the late 1800s with missions that centered on educating citizens. As the twentieth century unfolded, however, creating scientific knowledge through research became increasingly important to these universities. Many university presidents responded by creating visions centered on building the

scientific prestige of their schools. This created a dilemma for professors: Should they devote most of their time and energy to teaching students (as the mission required) or on their research studies (as ambitious presidents demanded via their visions)? Some universities continue to struggle with this trade-off today and remain houses divided against themselves. In sum, an organization is more effective to the extent that its vision and its mission target employees' effort in the same direction.

Pursuing the Vision and Mission through SMART Goals

An organization's vision and mission offer a broad, overall sense of the organization's direction. To work toward achieving these overall aspirations, organizations also need to create **goals**—narrower aims that should provide clear and tangible guidance to employees as they perform their work on a daily basis. The most effective goals are those that are specific, measurable, aggressive, realistic, and time-bound. An easy way to remember these dimensions is to combine the first letter of each into one word: SMART (Table 2.3 “Creating SMART Goals”). Employees are put in a good position to succeed to the extent that an organization's goals are SMART.

Table 2.3 Creating SMART Goals

While missions and visions provide an overall sense of the organization's direction, goals are narrower aims that should provide clear and tangible guidance to employees. The most effective goals are those that are SMART (specific, measurable, aggressive, realistic, and time-bound). SMART goals help provide clarity, transparency, and accountability. As detailed below, one SMART goal is Coca-Cola's aim to “by 2012, improve our water efficiency by 20%, compared with a 2004 baseline.”

Specific	Coca-Cola is seeking to improve its water efficiency by a specific amount—20%. In contrast, goals such as “do your best” are vague, making it difficult to decide if a goal is actually reached.
Measurable	Water efficiency can be calculated, so Coca-Cola is able to track its progress relative to its 20% target. If progress is slow, more resources can be devoted to achieving the goal.
Aggressive	A series of research studies have established that performance is strongest when goals are challenging but attainable. Reaching a 20% improvement will require aggressive work by Coke, but the goal can be reached.
Realistic	If Coca Cola's water efficiency goal was 95% improvement, Coca Cola's employees would probably react with surprise. Reaching a goal must be feasible in order for employees to embrace it. Unrealistic goals make most people give up. And basing goals on impossible clichés, such as “give 110%” creates confusion.
Time-bound	Coca Cola is seeking to achieve its 20% improvement by 2012. Some universities, such as Texas Tech University, provide incentives, including preferred scheduling for students who sign contracts agreeing to graduate on a four-year schedule. Deadlines such as these are motivating and they create accountability.

A goal is **specific** if it is explicit rather than vague. In May 1961, President John F. Kennedy proposed a specific goal in a speech to the US Congress: “I believe that this nation should commit itself to achieving the goal, before this decade is out, of landing a man on the moon and returning him safely to the earth (National Aeronautics and Space Administration).” Explicitness such as was offered in this goal is helpful because it targets people's energy. A few moments later, Kennedy

made it clear that such targeting would be needed if this goal was to be reached. Going to the moon, he noted, would require “a major national commitment of scientific and technical manpower, materiel and facilities, and the possibility of their diversion from other important activities where they are already thinly spread.” While specific goals make it clear how efforts should be directed, vague goals such as “do your best” leave individuals unsure of how to proceed.

A goal is **measurable** to the extent that whether the goal is achieved can be quantified. President Kennedy’s goal of reaching the moon by the end of the 1960s offered very simple and clear measurability: Either Americans would step on the moon by the end of 1969 or they would not. One of Coca-Cola’s current goals is a 20 percent improvement to its water efficiency by 2012 relative to 2004 water usage. Because water efficiency is easily calculated, the company can chart its progress relative to the 20 percent target and devote more resources to reaching the goal if progress is slower than planned.

A goal is **aggressive** if achieving it presents a significant challenge to the organization. A series of research studies have demonstrated that performance is strongest when goals are challenging but attainable. Such goals force people to test and extend the limits of their abilities. This can result in reaching surprising heights. President Kennedy captured this theme in a speech in September 1962: “We choose to go to the moon. We choose to go to the moon in this decade...not because [it is] easy, but because [it is] hard, because that goal will serve to organize and measure the best of our energies and skills.”

In the case of Coca-Cola, reaching a 20 percent improvement will require a concerted effort, but the goal can be achieved. Meanwhile, easily achievable goals tend to undermine motivation and effort. Consider a situation in which you have done so well in a course that you only need a score of 60 percent on the final exam to earn an A for the course. Understandably, few students would study hard enough to score 90 percent or 100 percent on the final exam under these circumstances. Similarly, setting organizational goals that are easy to reach encourages employees to work just hard enough to reach the goals.

It is tempting to extend this thinking to conclude that setting nearly impossible goals would encourage even stronger effort and performance than does setting aggressive goals. People tend to get discouraged and give up, however, when faced with goals that have little chance of being reached. If, for example, President Kennedy had set a time frame of one year to reach the moon, his goal would have attracted scorn. The country simply did not have the technology in place to reach such a goal. Indeed, Americans did not even orbit the moon until seven years after Kennedy’s 1961 speech. Similarly, if Coca-Cola’s water efficiency goal was 95 percent improvement, Coca-Cola’s employees would probably not embrace it. Thus goals must also be **realistic**, meaning that their achievement is feasible.

You have probably found that deadlines are motivating and that they help you structure your work time. The same is true for organizations, leading to the conclusion that goals should be **time-bound** through the creation of deadlines. Coca-Cola has set a deadline of 2012 for its water efficiency goal, for example. The deadline for President Kennedy’s goal was the end of 1969. The goal was actually reached a few months early. On July 20, 1969, Neil Armstrong became the first human to step foot on the moon. Incredibly, the pursuit of a well-constructed goal had helped people reach the moon in just eight years.



Americans landed on the moon eight years after President Kennedy set a moon landing as a key goal for the United States.

[Wikimedia Commons](#) – public domain.

The period after an important goal is reached is often overlooked but is critical. Will an organization rest on its laurels or will it take on new challenges? The US space program again provides an illustrative example. At the time of the first moon landing, *Time* magazine asked the leader of the team that built the moon rockets about the future of space exploration. “Given the same energy and dedication that took them to the moon,” said Wernher von Braun, “Americans could land on Mars as early as 1982 (Time, 1969).” No new goal involving human visits to Mars was embraced, however, and human exploration of space was de-emphasized in favor of robotic adventurers. Nearly three decades after von Braun’s proposed timeline for reaching Mars expired, President Barack Obama set in 2010 a goal of creating by 2025 a new space vehicle capable of taking humans beyond the moon and into deep space. This would be followed in the mid-2030s by a flight to orbit Mars as a prelude to landing on Mars (Amos, 2010). Time will tell whether these goals inspire the scientific community and the country in general (Table 2.4 “Be SMART: Vision, Mission, Goals, and You”).

Table 2.4 Be SMART: Vision, Mission, Goals, and You

Many of the principles for effective organizational vision, missions, and goals apply to individuals too. Here are some ideas that might help you think differently about your own aspirations and how you are working to reach them.

Vision	Young children often have grandiose visions, such as “I want to be the president of the United States.” Now that you are in college, what do you aspire to become? Is your education setting the stage for you to reach this vision?
Mission	Is your mission in life simply to accumulate as much wealth as you can? Or do you also place value on your role in a family and as a member of society?
Specific	Do you create explicit rather than vague goals for yourself? This can help you to target your energy toward what is important.
Measurable	Quantifying your goals allows you to track your accomplishments over time and can help reduce stress. For example, meeting a goal of “write a page every day” might prevent panic the night before an important project is due.
Aggressive	Creating aggressive educational goals (e.g. maintain a 3.5 GPA) is likely to lead to higher performance than minimal goals (e.g., pass all my classes).
Realistic	To better understand your prospects in the job market, consider researching what kinds of jobs are common for your major and experience level.
Time-Bound	Time management is a challenge in today’s world. If you tend to procrastinate, setting interim deadlines for yourself might help you to stay on schedule.

Key Takeaway

- Strategic leaders need to ensure that their organizations have three types of aims. A vision states what the organization aspires to become in the future. A mission reflects the organization’s past and present by stating why the organization exists and what role it plays in society. Goals are the more specific aims that organizations pursue to reach their visions and missions. The best goals are SMART: specific, measurable, aggressive, realistic, and time-bound.

Exercises

1. Take a look at the website of your college or university. What is the organization’s vision and mission? Were they easy or hard to find?
2. As a member of the student body, do you find the vision and mission of your college or university to be motivating and inspirational? Why or why not?
3. What is an important goal that you have established for your career? Could this goal be improved by applying the SMART goal concept?

References

Amos, J. 2010, April 15. Obama sets Mars goal for America. *BBC News*. Retrieved from <http://news.bbc.co.uk/2/hi/8623691.stm>.

National Aeronautics and Space Administration, Key documents in the history of space policy: 1960s. National Aeronautics and Space Administration. Retrieved from <http://history.nasa.gov/spdocs.html#1960s>.

Quigley, J. V. 1994. Vision: How leaders develop it, share it, and sustain it. *Business Horizons*, 37(5), 37–41.

Time, The Moon: Next, Mars and beyond. 1969, July 15. *Time*. Retrieved from <http://www.time.com/time/magazine/article/0,9171,901107,00.html>.

2.3 Assessing Organizational Performance

Learning Objectives

1. Understand the complexities associated with assessing organizational performance.
2. Learn each of the dimensions of the balanced scorecard framework.
3. Learn what is meant by a “triple bottom line.”

Organizational Performance: A Complex Concept

Organizational performance refers to how well an organization is doing to reach its vision, mission, and goals. Assessing organizational performance is a vital aspect of strategic management. Executives must know how well their organizations are performing to figure out what strategic changes, if any, to make. Performance is a very complex concept, however, and a lot of attention needs to be paid to how it is assessed.

Two important considerations are (1) performance measures and (2) performance referents (Figure 2.5 “How Organizations and Individuals Can Use Financial Performance Measures and Referents”). A **performance measure** is a metric along which organizations can be gauged. Most executives examine measures such as profits, stock price, and sales in an attempt to better understand how well their organizations are competing in the market. But these measures provide just a glimpse of organizational performance. Performance referents are also needed to assess whether an organization is doing well. A **performance referent** is a benchmark used to make sense of an organization’s standing along a performance measure. Suppose, for example, that a firm has a profit margin of 20 percent in 2011. This sounds great on the surface. But suppose that the firm’s profit margin in 2010 was 35 percent and that the average profit margin across all firms in the industry for 2011 was 40 percent. Viewed relative to these two referents, the firm’s 2011 performance is cause for concern.

Using a variety of performance measures and referents is valuable because different measures and referents provide different information about an organization’s functioning. The parable of the blind men and the elephant—popularized in Western cultures through a poem by John Godfrey Saxe in the nineteenth century—is useful for understanding the complexity associated with measuring organizational performance. As the story goes, six blind men set out to “see” what an elephant was like. The first man touched the elephant’s side and believed the beast to be like a great wall. The second felt the tusks and thought elephants must be like spears. Feeling the trunk, the third man thought it was a type of snake. Feeling a limb, the fourth man thought it was like a tree trunk. The fifth, examining an ear, thought it was like a fan. The sixth, touching the tail, thought it was like a rope. If the men failed to communicate their different impressions they would have all been partially right but wrong about what ultimately mattered.

Figure 2.5 How Organizations and Individuals Can Use Financial Performance Measures and Referents

Types of Measures	Applications for Organizations		Application for Individuals	
	Key Measure	Key Referent	Key Measure	Key Referent
Liquidity measures: Helpful for understanding if obligations can be paid when due.	Current ratio (Current assets/ Current liabilities)	A ratio of less than 1.0 suggests the firm does not have enough cash to pay its bills.	Cash in your checking account.	Do you have enough cash to cover your monthly debts?
Leverage measures: Helpful for understanding if debt level is too high. The term <i>leverage</i> refers to the extent to which borrowed money is used.	Debt-to-equity ratio	Competitors' debt-to-equity ratios. The use of debt varies across industries. Auto companies, for example, tend to have high debt-to-equity because they must build massive factories.	Debt-to-income ratio (Monthly debt payments / Monthly income)	If you have a debt-to-income ratio higher than 40%, you may be on the verge of becoming a credit risk.
Profitability measures: Helpful for understanding how much profit, if any, is really being made.	Net income (income after taxes)	Last year's net income. An increase shows the firm's profits are moving in the right direction.	Net income (income after taxes)	Are you making enough money to cover your yearly expenses and save for retirement?

This story parallels the challenge involved in understanding the multidimensional nature of organization performance because different measures and referents may tell a different story about the organization's performance. For example, the *Fortune* 500 lists the largest US firms in terms of sales. These firms are generally not the strongest performers in terms of growth in stock price, however, in part because they are so big that making major improvements is difficult. During the late 1990s, a number of Internet-centered businesses enjoyed exceptional growth in sales and stock price but reported losses rather than profits. Many investors in these firms who simply fixated on a single performance measure—sales growth—absorbed heavy losses when the stock market's attention turned to profits and the stock prices of these firms plummeted.



The story of the blind men and the elephant provides a metaphor for understanding the complexities of measuring organizational performance.

[Wikimedia Commons](#) – public domain.

The number of performance measures and referents that are relevant for understanding an organization's performance can be overwhelming, however. For example, a study of what performance metrics were used within restaurant organizations' annual reports found that 788 different combinations of measures and referents were used within this one industry in a single year (Short & Palmer, 2003). Thus executives need to choose a rich yet limited set of performance measures and referents to focus on.

The Balanced Scorecard

To organize an organization's performance measures, Professor Robert Kaplan and Professor David Norton of Harvard University developed a tool called the **balanced scorecard**. Using the scorecard helps managers resist the temptation to fixate on financial measures and instead monitor a diverse set of important measures ([Table 2.6 "Beyond Profits: Measuring Performance Using the Balanced Scorecard"](#)). Indeed, the idea behind the framework is to provide a "balance" between financial measures and other measures that are important for understanding organizational activities that lead to sustained, long-term performance. The balanced scorecard recommends that managers gain an overview of the organization's performance by tracking a small number of key measures that collectively reflect four dimensions: (1) financial, (2) customer, (3) internal business process, and (4) learning and growth (Kaplan & Norton, 1992).

Table 2.6 Beyond Profits: Measuring Performance Using the Balanced Scorecard

Because the concept of organizational performance is multidimensional, wise managers realize that understanding organizational performance is like flying a plane pilots must be on track in terms of altitude, air speed, and oil pressure and make sure they have enough gas to finish their flight plan. For tracking organizational performance, assessing how the organization is doing financially is just a starting point. The "balanced scorecard" encourages managers to also monitor how well the organization

is serving customers, managing internal activities, and setting the stage for future improvements. This provides a fast but comprehensive view of the organization. As shown below, monitoring these four dimensions also can help individuals assess themselves.

Scorecard Point	Definition	You could ask yourself...
Financial measures	such as <i>return on assets</i> and <i>stock price</i> —relate to effectiveness and profits.	How can I improve my personal wealth? Measures might include cash, savings account, and retirement.
Customer measures	such as <i>number of new or repeat customers</i> and <i>percentage of repeat customers</i> —relate to customer attraction and satisfaction.	How strong is my social network? The number of new contacts you make over time might reflect this dimension.
Internal business process measures	such as <i>speed at serving a customer</i> and <i>time it takes to create a new product and get it to market</i> —relate to organizational efficiency.	Am I getting better at my current job? Tracking improvements in personal efficiency such as the time needed to complete a task can be helpful.
Learning and growth measures	such as the <i>average number of new skills learned by each employee every year</i> —relate to the future and emphasize that employee learning is often more important than formal training.	What skills should I develop now for the future? Although the acquisition of new skills is hard to measure, the attainment of specialized licenses or earning of a graduate degree are tangible benchmarks.

Financial Measures

Financial measures of performance relate to organizational effectiveness and profits. Examples include financial ratios such as return on assets, return on equity, and return on investment. Other common financial measures include profits and stock price. Such measures help answer the key question “How do we look to shareholders?”

Financial performance measures are commonly articulated and emphasized within an organization’s annual report to shareholders. To provide context, such measures should be objective and be coupled with meaningful referents, such as the firm’s past performance. For example, Starbucks’s 2009 annual report highlights the firm’s performance in terms of net revenue, operating income, and cash flow over a five-year period.

Customer Measures

Customer measures of performance relate to customer attraction, satisfaction, and retention. These measures provide insight to the key question “How do customers see us?” Examples might include the number of new customers and the percentage of repeat customers.

Starbucks realizes the importance of repeat customers and has taken a number of steps to satisfy and to attract regular visitors to their stores. For example, Starbucks rewards regular customers with free drinks and offers all customers free Wi-Fi access (Miller, 2010). Starbucks also encourages repeat visits by providing cards with codes for free iTunes downloads. The featured songs change regularly, encouraging frequent repeat visits.

Internal Business Process Measures

Internal business process measures of performance relate to organizational efficiency. These measures help answer the key question “What must we excel at?” Examples include the time it takes to manufacture the organization’s good or deliver a service. The time it takes to create a new product and bring it to market is another example of this type of measure.

Organizations such as Starbucks realize the importance of such efficiency measures for the long-term success of its organization, and Starbucks carefully examines its processes with the goal of decreasing order fulfillment time. In one recent example, Starbucks efficiency experts challenged their employees to assemble a Mr. Potato Head to understand how work could be done more quickly (Jargon, 2009). The aim of this exercise was to help Starbucks employees in general match the speed of the firm’s high performers, who boast an average time per order of twenty-five seconds.

Learning and Growth Measures

Learning and growth measures of performance relate to the future. Such measures provide insight to tell the organization, “Can we continue to improve and create value?” Learning and growth measures focus on innovation and proceed with an understanding that strategies change over time. Consequently, developing new ways to add value will be needed as the organization continues to adapt to an evolving environment. An example of a learning and growth measure is the number of new skills learned by employees every year.

One way Starbucks encourages its employees to learn skills that may benefit both the firm and individuals in the future is through its tuition reimbursement program. Employees who have worked with Starbucks for more than a year are eligible. Starbucks hopes that the knowledge acquired while earning a college degree might provide employees with the skills needed to develop innovations that will benefit the company in the future. Another benefit of this program is that it helps Starbucks reward and retain high-achieving employees.

Measuring Performance Using the Triple Bottom Line

Ralph Waldo Emerson once noted, “Doing well is the result of doing good. That’s what capitalism is all about.” While the balanced scorecard provides a popular framework to help executives understand an organization’s performance, other frameworks highlight areas such as social responsibility. One such framework, the [triple bottom line](#), emphasizes the three Ps of *people* (making sure that the actions of the organization are socially responsible), the *planet* (making sure organizations act in a way that promotes environmental sustainability), and traditional organization *profits*. This notion was introduced in the early 1980s but did not attract much attention until the late 1990s.



The triple bottom line emphasizes the three Ps of people (social concerns), planet (environmental concerns), and profits (economic concerns).

In the case of Starbucks, the firm has made clear the importance it attaches to the planet by creating an

environmental mission statement (“Starbucks is committed to a role of environmental leadership in all facets of our business”) in addition to its overall mission (Starbucks, 2011). In terms of the “people” dimension of the triple bottom line, Starbucks strives to purchase coffee beans harvested by farmers who work under humane conditions and are paid reasonable wages. The firm works to be profitable as well, of course.

Key Takeaway

- Organizational performance is a multidimensional concept, and wise managers rely on multiple measures of performance when gauging the success or failure of their organizations. The balanced scorecard provides a tool to help executives gain a general understanding of their organization’s current level of achievement across a set of four important dimensions. The triple bottom line provides another tool to help executives focus on performance targets beyond profits alone; this approach stresses the importance of social and environmental outcomes.

Exercises

1. How might you apply the balanced scorecard framework to measure performance of your college or university?
2. Identify a measurable example of each of the balanced scorecard dimensions other than the examples offered in this section.
3. Identify a mission statement from an organization that emphasizes each of the elements of the triple bottom line.

References

- Jargon, J. 2009, August 4. Latest Starbucks buzzword: “Lean” Japanese techniques. *Wall Street Journal*, p. A1..
- Kaplan, R. S., & Norton, D. 1992, February. The balanced scorecard: Measures that drive performance. *Harvard Business Review*, 70–79.
- Miller, C. 2010, June 15. Aiming at rivals, Starbucks will offer free Wi-Fi. *New York Times*. Section B, p. 1.
- Short, J. C., & Palmer, T. B. 2003. Organizational performance referents: An empirical examination of their content and influences. *Organizational Behavior and Human Decision Processes*, 90, 209–224.
- Starbucks, Our Starbucks mission statement. Retrieved on March 31, 2011, from <http://www.starbucks.com/about-us/company-information/mission-statement>. Accessed March 31, 2011.

2.4 The CEO as Celebrity

Learning Objectives

1. Understand the benefits and costs of CEO celebrity status.
2. List and define the four types of CEOs based on differences in fame and reputation.
3. Be able to offer an example of each of the four types of CEOs

Table 2.7 CEO

At the top of every organization sits a chief executive office (CEO) who serves as the main architect of its strategy and, in many cases, as the face of the organization. Some CEOs such as Steve Jobs, Mark Zuckerberg, Richard Branson, and Oprah Winfrey have enough personality and influence in business and society that they become celebrities, much like sports and movie stars. Celebrity status can provide great visibility for an organization, but it can also cause harm if a CEO makes major mistakes. Meanwhile, other CEOs toil away in relative obscurity. Some produce good results that escape public attention, while others should be thankful that their poor work goes unnoticed. Considering CEOs' relative fame and reputation together allows us to identify four types of CEOs.

CEO Reputation

	Low CEO Reputation	High CEO Reputation
High CEO Fame	Scoundrels–In the early 2000s, several high profile CEOs played central roles in ethical scandals. One was Enron CEO Kenneth Lay, who in 2006 was convicted of crimes related corporate abuse and accounting fraud. He later committed suicide.	Icons–A rare combination of style and substance leads these CEOs to become household names. The “Oracle of Omaha” Warren Buffett has advised presidents, and the yearly letters he writes to his shareholders are as influential as any report created by the Federal Reserve and other financial institutions.
Low CEO Fame	Silent Killers–These unknown CEOs can be just as harmful to their firms as celebrity scoundrels. Harding Lawrence, former CEO of now defunct airline Braniff International, made a major blunder by expanding the airline too quickly. Lawrence was fired before the firm plunged into bankruptcy. By the time Braniff disappeared into history, Lawrence’s poor decisions were largely forgotten.	Hidden Gems–These CEOs perform their jobs admirably, but they lack fame. Many prefer to avoid the spotlight, but they are known all too well by their wary competitors. Anne Mulcahy, CEO of Xerox, is a hidden gem whose avoidance of media attention may stem from her humble roots as a copier salesperson.

Benefits and Costs of CEO Celebrity

The nice thing about being a celebrity is that when you bore people, they think it's their fault.

Henry Kissinger, former US Secretary of State

The word *celebrity* quickly brings to mind actors, sports stars, and musicians. Some CEOs, such as Bill Gates, Oprah Winfrey, Martha Stewart, and Donald Trump, also achieve celebrity status. Celebrity CEOs are not a new phenomenon. In the early twentieth century, industrial barons such as Henry Ford, John D. Rockefeller, and Cornelius Vanderbilt were household names. However, in the current era of mass and instant media, celebrity CEOs have become more prevalent and visible ([Table 2.7 "CEO"](#)) (Ketchen, et. al., 2008).

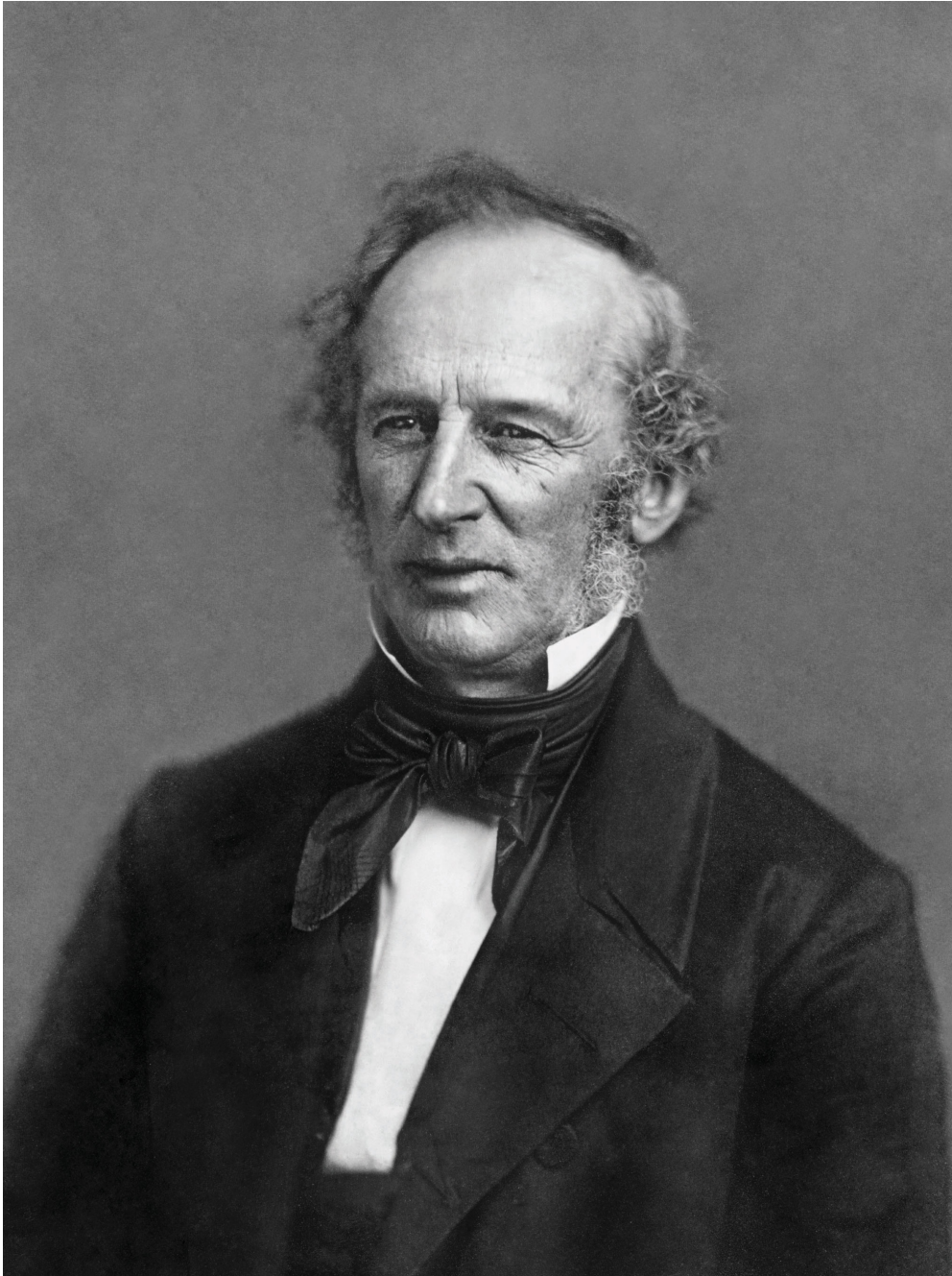

Cornelius Vanderbilt was one of the earliest celebrity CEOs; Vanderbilt University serves as his legacy.

[Wikimedia Commons](#) – public domain.

Both benefits and costs are associated with CEO celebrity. As the quote from Henry Kissinger suggests, celebrity confers a mystique and reverence that can be leveraged in a variety of ways. CEO celebrity can serve as an intangible asset for the CEO's firm and may increase opportunities available to the firm. Hiring or developing a celebrity CEO may increase stock price, enhance a firm's image, and improve the morale of employees and other stakeholders. However, employing a celebrity CEO also entails risks for an organization. Increased attention to the firm via the celebrity CEO

means any gaps between actual and expected firm performance are magnified. Further, if a celebrity CEO acts in an unethical or illegal manner, chances are that the CEO's firm will receive much more media attention than will other firms with similar problems (Ranft, et. al., 2006).

There are also personal benefits and risks associated with celebrity for the CEO. Celebrity CEOs tend to receive higher compensation and job perks than their colleagues. Celebrity CEOs are likely to enjoy increased prestige power, which facilitates invitations to serve on the boards of directors of other firms and creates opportunities to network with other "managerial elites." Celebrity also can provide CEOs with a "benefit of the doubt" effect that protects against quick sanctions for downturns in firm performance and stock price. However, celebrity also creates potential costs for individuals. Celebrity CEOs face larger and more lasting reputation erosion if their job performance and behavior is inconsistent with their celebrity image. Celebrity CEOs face increased personal media scrutiny, and their friends and family must often endure increased attention into their personal and public lives. Accordingly, wise CEOs will attempt to understand and manage their celebrity status (Wade, et. al., 2008).

Types of CEOs

Icons are CEOs possessing both fame and strong reputations. The icon CEO combines style and substance in the execution of his or her job responsibilities. Mary Kay Ash, Richard Branson, Bill Gates, and Warren Buffett are good examples of icons. The late Mary Kay Ash founded Mary Kay Cosmetics Corporation. The firm's great success and Ash's unconventional motivational methods, such as rewarding sales representatives with pink Cadillacs, made her famous. Partly because she emphasized helping other women succeed and ethical business practices, Mary Kay Ash also had a very positive reputation. Richard Branson has created an empire with more than four hundred companies, including Virgin Atlantic Airways and Virgin Records. Branson's celebrity status led him to star in his own reality-based show. He has also appeared on television series such as *Baywatch* and *Friends*, in addition to several cameo appearances in major motion pictures. Bill Gates, founder and former CEO of Microsoft, also has fame and a largely positive reputation. Gates is a proverbial "household name" in the tradition of Ford, Rockefeller, and Vanderbilt. He also is routinely listed among *Time* magazine's "100 Most Influential People" and has received "rock star" receptions in India and Vietnam in recent years.



Former Microsoft CEO Bill Gates exemplifies a CEO who has reached icon status.

[Wikimedia Commons](#) – CC BY-SA 2.0.

Warren Buffett is perhaps the best-known executive in the United States. As CEO of Berkshire Hathaway, he has accumulated wealth estimated at \$62 billion and was the richest person in the world as of March 2008. Buffett's business insights command a level of respect that is perhaps unrivaled. Many in the investment and policymaking communities pay careful attention to his investment choices and his commentary on economic conditions. Despite Buffett's immense wealth and success, his reputation centers on humility and generosity. Buffett avoids the glitz of Wall Street and has lived for fifty years in a house he bought in Omaha, Nebraska, for \$31,000. Meanwhile, his 2006 donation of approximately \$30 billion to the Bill and Melinda Gates Foundation was the largest charitable gift in history.

CEOs who display high levels of relative fame but low levels of reputation are in the group called **scoundrels**. These CEOs are well known but vilified. The late Leona Helmsley was a prototypical scoundrel. Leona Helmsley's life was a classic rags-to-riches story. Born to immigrant parents, Helmsley became a billionaire through her work as the head of an extensive hotel and real estate empire. While certainly famous, her reputation was anything but positive, as reflected by her nickname: the Queen of Mean. During Helmsley's trial for tax fraud, her housekeeper quoted her as proclaiming, "We don't pay taxes. Only the little people pay taxes." Following twenty-one months in jail, Helmsley was required to perform 750 hours of community service. One hundred fifty hours were added to this sentence after it was discovered that employees had performed some of her service hours. Helmsley's apparent arrogance, combined with her cruelty to employees and her reputation as the ultimate workplace bully, cemented her position as a scoundrel.

The corporate governance scandals of the early 2000s revealed several CEOs as scoundrels. Perhaps the best known were Kenneth Lay and Dennis Kozlowski. Both men rose to prominence as their firms' success and stock prices soared but were undone by dubious activities. Lay was once revered as the son of a poor minister who founded Enron and built it into a giant in the energy business. In 2001, however, he became the face of corporate abuses in the United

States after Enron's collapse led to scenes, captured on television, of employees left jobless and with retirement accounts full of worthless Enron stock. Lay was convicted of fraud in 2006 but died before sentencing.

Also born to a poor family, Kozlowski started at Tyco as an accountant and worked his way up to the executive suite. In May 2001, a *BusinessWeek* cover story lauded Kozlowski as “the most aggressive CEO” in the country and detailed his strategy for building Tyco into the next General Electric by using acquisitions to gain the first or second position in all the industries in which it competed. By 2002, Kozlowski's reputation was in jeopardy. He was indicted for avoiding more than \$1 million in sales taxes on art purchases. Media stories described in detail a \$2 million birthday party Kozlowski threw for his wife (billing half of it to Tyco as a company function), a \$19 million apartment Tyco purchased for him, and \$11 million worth of furnishings for the apartment (including an infamous \$6,000 shower curtain). Accusations that Kozlowski and another Tyco executive stole hundreds of millions of dollars from the firm ultimately led to a prison sentence of eight to twenty-five years.

Hidden gems are CEOs who lack fame but possess positive reputations. These CEOs toil in relative obscurity while leading their firms to success. Their skill as executives is known mainly by those in their own firm and by their competitors. In many cases, the firm has some renown due to its success, but the CEO stays unknown. For example, consider the case of Anne Mulcahy. Mulcahy, CEO of Xerox, started her career at Xerox as a copier salesperson. Despite building an excellent reputation by rescuing Xerox from near bankruptcy, Mulcahy eschews fame and publicity. While being known for successfully leading Xerox by example and being willing to fly anywhere to meet a customer, she avoids stock analysts and reporters.

Silent killers are the fourth and final group of CEOs. These CEOs are overlooked and ignored sources of harm to their firms. While scoundrels are closely monitored and scrutinized by the media, it may be too late before the poor ethics or incompetence of the silent killers is detected. In this sense, silent killers are sometimes worse than scoundrels. One example of a silent killer is Harding Lawrence, former CEO of defunct Braniff International. Lawrence initiated a massive expansion of the airline following industry deregulation in the late 1970s. The result was a bloated firm, ill-equipped to survive the extremely competitive setting that evolved in the early 1980s. Howard Putnam, the CEO of a small regional carrier named Southwest Airlines, was hired in a failed effort to save the company. By the time Braniff went bankrupt, Putnam was left to explain its demise, and the name of the main culprit was all but forgotten. Ironically, had Putnam declined the opportunity to try to save Braniff, perhaps he and not Herb Kelleher would have become an icon at the helm of Southwest.

Strategy at the Movies

Iron Man

Has Tony Stark gone crazy? This was the question that many stakeholders of Stark Industries were asking themselves in the 2008 blockbuster *Iron Man*. Tony Stark, CEO of Stark Industries, stunned his shareholders, employees, and the world when he announced that he was changing Stark Industries' mission from being one of the world's leading weapons manufacturers to being a socially responsible, clean energy producer. Following his announcement, Stark faced fierce opposition from his board of directors, employees, the media, and clients such as the US military. The changes at Stark Industries attracted tremendous attention in part because of the glamorous Stark's status as a celebrity CEO. Initially, Stark is seen by the public as a scoundrel that pays little attention to the social impact his company makes. After shifting the direction of Stark Industries, however, Stark is viewed as an icon that is just as attentive to the social performance of the company as he is to its financial performance. *Iron Man* illustrates that while changing elements such as firm mission and CEO status is difficult, it is not impossible.



Iron Man: The Greatest Creation of Fictional Celebrity CEO Tony Stark

The Community – Pop Culture Geek – [Comic-Con 2010](#) – [Hasbro booth](#) – [Iron Man armor](#) – CC BY 2.0.

Celebrity Rehabilitation

Anything I say or do is now at risk of showing up on the front page of a national daily newspaper and therefore, I need to be much more conscious about the implications of everything that I say or do in all situations.

John Mackey, CEO of Whole Foods Market

Achieving the level of success that brings about celebrity is seldom a completely smooth process. Even well-regarded celebrity CEOs seldom have totally untarnished reputations. Bill Gates has been portrayed as a ruthless and devious genius, for example, while General Electric CEO Jack Welch was attacked in media outlets for an extramarital affair.

One of the more interesting recent cases of a tarnished reputation centers on John Mackey, founder and CEO of Whole Foods Market. His strategy of offering organic food and high levels of service allowed Whole Foods to carve out a profitable and growing niche in an industry whose overall margins have been squeezed as Walmart's Supercenters have gained market share. Under Mackey's leadership, Whole Food's stock price tripled from 2001 to 2006. Mackey's efforts to make food supplies healthier and his teamwork-centered management approach attracted publicity, and he appeared headed for icon status.

But in 2007 Mackey and Whole Foods were embarrassed by the revelation that Mackey had been anonymously posting negative information about a rival, Wild Oats, online. Through his online persona "rahodeb" (a scrambling of his wife's name), Mackey asserted that Wild Oats' stock was overpriced and that the firm was headed toward bankruptcy. This was viewed by some observers as a possible effort to manipulate Wild Oats' stock price prior to a proposed acquisition by Whole Foods. Meanwhile, in e-mails to other Whole Foods executives, Mackey noted that the acquisition of Wild Oats could allow them to avoid "nasty price wars." This caught the eye of Federal Trade Commission (FTC) regulators who were concerned about the antitrust implications of the acquisition.



Whole Foods CEO John Mackey's celebrity status was amplified when it was revealed that he had posted negative information online about competitor Wild Oats.

[Wikimedia Commons](#) – CC BY 2.0.

What should a CEO do when his or her reputation takes a hit? As the old saying goes, honesty is the best policy. An example is offered by David Neeleman, founder and CEO of JetBlue. The reputations of JetBlue and Neeleman took a severe blow after a widely reported February 2007 debacle in which travelers were stranded in airplanes for excessive periods of time during a busy holiday weekend. Neeleman took a giant step toward restoring both his and JetBlue's reputation by issuing a public, heartfelt apology. He not only issued a written apology to customers but also bought

full-page advertisements in newspapers, posted a video apology online, and created a new “bill of rights” for JetBlue customers.

Mackey apologized for his actions via his blog in 2008. As part of this apology, Mackey acknowledged that he had failed to recognize how expectations change when one becomes a celebrity. Mackey noted that when Whole Foods was a smaller company, “I was seldom interviewed and few people knew or cared who I was. I wasn’t a public figure and had no desire to become one.” As his company grew, however, Mackey became subject to more scrutiny. As Mackey put it, “At some point in the past 10 years I went from being a relatively unknown person to becoming a public figure. I regret not having the wisdom to recognize this fact until very recently (Mackey, 2008).” A big part of managing celebrity status is realizing that one is in fact a celebrity.

Key Takeaway

- The media exposure common to modern CEOs provides the opportunity for such top executives to reach celebrity status. While this status can provide positive benefits to their firms such as increased performance, CEOs should be aware of and manage the potential for increased scrutiny associated with this status.

Exercises

1. Can you identify another example of a celebrity CEO, such as Cornelius Vanderbilt, that existed prior to the 1900s?
2. Identify examples of icons, scoundrels, hidden gems, and silent killers other than the examples offered in this section.
3. Would you enjoy the media attention associated with CEO celebrity, or would you prefer to hide from the limelight? Does your answer have implications for your future career choices?

References

Ketchen, D., Adams, G., & Shook, C. 2008. Understanding and managing CEO celebrity. *Business Horizons*, 51(6), 529–534.

Mackey, John blog. 2008, May 21. Re: Apology. Retrieved from <http://www2.wholefoodsmarket.com/blogs/jmackey/2008/05/21/back-to-blogging/#more-26>.

Ranft, A. L., Zinko, R., Ferris, G. R., & Buckley, M. R. 2006. Marketing the image of management: The costs and benefits of CEO reputation. *Organizational Dynamics*, 35(3), 279–290.

Wade, J. B., Porac, J. F., Pollock, T. G., & Graffin, S. D. 2008. Star CEOs: Benefit or burden? *Organizational Dynamics*, 37(2), 203–210.

2.5 Entrepreneurial Orientation

Table 2.8 Understanding Entrepreneurial Orientation

A famous Nike slogan encourages people to “just do it!” For people and organizations that have developed an entrepreneurial orientation, “just do it!” is a way of life. While often associated with starting new ventures, an entrepreneurial orientation can be very valuable to established organizations too. Below we describe each of the five characteristics associated with an entrepreneurial orientation: autonomy, competitive aggressiveness, innovativeness, proactiveness, and risk-taking.

<p>Autonomy – The tendency to bring forth ideas and see them through to completion.</p>	<p>Microsoft’s values statement notes, “We take on big challenges, and pride ourselves on seeing them through.” For example, Microsoft embraced a huge challenge when developing and launching its Xbox gaming system to compete with market leaders Nintendo and Sony.</p>
<p>Competitive Aggressiveness – The tendency to intensely and directly challenge rivals rather than trying to avoid competition.</p>	<p>One of Nike’s past mission statements — “To experience the emotion of competition, winning, and crushing competitors” — highlights its aggressiveness.</p>
<p>Innovativeness – The tendency to pursue novel ideas, creative processes, and experimentation.</p>	<p>3M has built its business around its mission statement: to solve unsolved problems innovatively. 3M employs over 7,000 researchers and it was awarded nearly 600 patents in 2010. 3M’s innovativeness has led it to develop thousands of products (such as Post-it notes and Scotch tape) that are sold in almost 200 countries.</p>
<p>Proactiveness – The tendency to anticipate and act on future opportunities rather than rely solely on existing products and services.</p>	<p>Proactive Communications Inc. lives up to its name by focusing on emerging and unusual opportunities. The firm embraces contracts in war zones and natural disaster areas that are often avoided by other telecommunications firms.</p>
<p>Risk Taking – The tendency to take bold actions rather than being cautious.</p>	<p>Richard Brandson’s launching of Virgin Galactic — a company that plans to offer suborbital spaceflights to commercial passengers — reflects his love of high-risk, high-reward ventures.</p>

Learning Objectives

1. Understand how thinking and acting entrepreneurially can help organizations and individuals.
2. List and define the five dimensions of an entrepreneurial orientation.

The Value of Thinking and Acting Entrepreneurially

When asked to think of an entrepreneur, people typically offer examples such as Howard Schultz, Estée Lauder, and Michael Dell—individuals who have started their own successful businesses from the bottom up that generated a lasting impact on society. But entrepreneurial thinking and doing are not limited to those who begin in their garage with a new idea, financed by family members or personal savings. Some people in large organizations are filled with passion for a new idea, spend their time championing a new product or service, work with key players in the organization to build a constituency, and then find ways to acquire the needed resources to bring the idea to fruition. Thinking and behaving entrepreneurially can help a person's career too. Some enterprising individuals successfully navigate through the environments of their respective organizations and maximize their own career prospects by identifying and seizing new opportunities ([Table 2.8 "Understanding Entrepreneurial Orientation"](#)) (Certo, et. al., 2009).



As a college student, Michael Dell demonstrated an entrepreneurial orientation by starting a computer-upgrading business in his dorm room. He later founded Dell Inc.

[Wikimedia Commons](#) – CC BY-SA 3.0.

In the 1730s, Richard Cantillon used the French term *entrepreneur*, or literally “undertaker,” to refer to those who undertake self-employment while also accepting an uncertain return. In subsequent years, entrepreneurs have also been referred to as innovators of new ideas (Thomas Edison), individuals who find and promote new combinations of factors of production (Bill Gates’ bundling of Microsoft’s products), and those who exploit opportunistic ideas to expand small enterprises (Mark Zuckerberg at Facebook). The common elements of these conceptions of entrepreneurs are that they do something new and that some individuals can make something out of opportunities that others cannot.

Entrepreneurial orientation (EO) is a key concept when executives are crafting strategies in the hopes of doing something new and exploiting opportunities that other organizations cannot exploit. EO refers to the processes, practices, and decision-making styles of organizations that act entrepreneurially (Lumpkin & Dess, 1996). Any organization’s level of EO can be understood by examining how it stacks up relative to five dimensions: (1) autonomy, (2) competitive aggressiveness, (3) innovativeness, (4) proactiveness, (5) and risk taking. These dimensions are also relevant to individuals.

Autonomy

Autonomy refers to whether an individual or team of individuals within an organization has the freedom to develop an entrepreneurial idea and then see it through to completion. In an organization that offers high autonomy, people are offered the independence required to bring a new idea to fruition, unfettered by the shackles of corporate bureaucracy. When individuals and teams are unhindered by organizational traditions and norms, they are able to more effectively investigate and champion new ideas.

Some large organizations promote autonomy by empowering a division to make its own decisions, set its own objectives, and manage its own budgets. One example is Sony’s PlayStation group, which was created by chief operating officer (COO) Ken Kutaragi, largely independent of the Sony bureaucracy. In time, the PlayStation business was responsible for nearly all Sony’s net profit. Because of the success generated by the autonomous PlayStation group, Kutaragi later was tapped to transform Sony’s core consumer electronics business into a PlayStation clone. In some cases, an autonomous unit eventually becomes completely distinct from the parent company, such as when Motorola spun off its successful semiconductor business to create Freescale.

Competitive Aggressiveness

Competitive aggressiveness is the tendency to intensely and directly challenge competitors rather than trying to avoid them. Aggressive moves can include price-cutting and increasing spending on marketing, quality, and production capacity. An example of competitive aggressiveness can be found in Ben & Jerry’s marketing campaigns in the mid-1980s, when Pillsbury’s Häagen-Dazs attempted to limit distribution of Ben & Jerry’s products. In response, Ben & Jerry’s launched their “What’s the Doughboy Afraid Of?” advertising campaign to challenge Pillsbury’s actions. This marketing action was coupled with a series of lawsuits—Ben & Jerry’s was competitively aggressive in both the marketplace and the courtroom.

Although aggressive moves helped Ben & Jerry’s, too much aggressiveness can undermine an organization’s success. A small firm that attacks larger rivals, for example, may find itself on the losing end of a price war. Establishing a reputation for competitive aggressiveness can damage a firm’s chances of being invited to join collaborative efforts such as joint ventures and alliances. In some industries, such as the biotech industry, collaboration is vital because no single firm has the knowledge and resources needed to develop and deliver new products. Executives thus must be wary of taking competitive actions that destroy opportunities for future collaborating.

Innovativeness

Innovativeness is the tendency to pursue creativity and experimentation. Some innovations build on existing skills to create incremental improvements, while more radical innovations require brand-new skills and may make existing skills

obsolete. Either way, innovativeness is aimed at developing new products, services, and processes. Those organizations that are successful in their innovation efforts tend to enjoy stronger performance than those that do not.

Known for efficient service, FedEx has introduced its Smart Package, which allows both shippers and recipients to monitor package location, temperature, and humidity. This type of innovation is a welcome addition to FedEx's lineup for those in the business of shipping delicate goods, such as human organs. How do firms generate these types of new ideas that meet customers' complex needs? Perennial innovators 3M and Google have found a few possible answers. 3M sends nine thousand of its technical personnel in thirty-four countries into customers' workplaces to experience firsthand the kinds of problems customers encounter each day. Google's two most popular features of its Gmail, thread sorting and unlimited e-mail archiving, were first suggested by an engineer who was fed up with his own e-mail woes. Both firms allow employees to use a portion of their work time on projects of their own choosing with the goal of creating new innovations for the company. This latter example illustrates how multiple EO dimensions—in this case, autonomy and innovativeness—can reinforce one another.



Ben & Jerry's displays innovativeness by developing a series of offbeat and creative flavors over time.

[Flickr](#) – CC BY-SA 2.0.

Proactiveness

Proactiveness is the tendency to anticipate and act on future needs rather than reacting to events after they unfold. A proactive organization is one that adopts an opportunity-seeking perspective. Such organizations act in advance of shifting market demand and are often either the first to enter new markets or “fast followers” that improve on the initial efforts of first movers.

Consider Proactive Communications, an aptly named small firm in Killeen, Texas. From its beginnings in 2001, this firm has provided communications in hostile environments, such as Iraq and areas impacted by Hurricane Katrina. Being proactive in this case means being willing to don a military helmet or sleep outdoors—activities often avoided by other telecommunications firms. By embracing opportunities that others fear, Proactive’s executives have carved out a lucrative niche in a world that is technologically, environmentally, and politically turbulent (Choi, 2008).

Risk Taking

Risk taking refers to the tendency to engage in bold rather than cautious actions. Starbucks, for example, made a risky move in 2009 when it introduced a new instant coffee called VIA Ready Brew. Instant coffee has long been viewed by many coffee drinkers as a bland drink, but Starbucks decided that the opportunity to distribute its product in a different format was worth the risk of associating its brand name with instant coffee.

Although a common belief about entrepreneurs is that they are chronic risk takers, research suggests that entrepreneurs do not perceive their actions as risky, and most take action only after using planning and forecasting to reduce uncertainty (Simon, et. al., 2000). But uncertainty seldom can be fully eliminated. A few years ago, Jeroen van der Veer, CEO of Royal Dutch Shell PLC, entered a risky energy deal in Russia’s Far East. At the time, van der Veer conceded that it was too early to know whether the move would be successful (Certo, et. al., 2008). Just six months later, however, customers in Japan, Korea, and the United States had purchased all the natural gas expected to be produced there for the next twenty years. If political instabilities in Russia and challenges in pipeline construction do not dampen returns, Shell stands to post a hefty profit from its 27.5 percent stake in the venture.

Building an Entrepreneurial Orientation

Steps can be taken by executives to develop a stronger entrepreneurial orientation throughout an organization and by individuals to become more entrepreneurial themselves. For executives, it is important to design organizational systems and policies to reflect the five dimensions of EO. As an example, how an organization’s compensation systems encourage or discourage these dimensions should be considered. Is taking sensible risks rewarded through raises and bonuses, regardless of whether the risks pay off, for example, or does the compensation system penalize risk taking? Other organizational characteristics such as corporate debt level may influence EO. Do corporate debt levels help or impede innovativeness? Is debt structured in such a way as to encourage risk taking? These are key questions for executives to consider.

Examination of some performance measures can assist executives in assessing EO within their organizations. To understand how the organization develops and reinforces autonomy, for example, top executives can administer employee satisfaction surveys and monitor employee turnover rates. Organizations that effectively develop autonomy should foster a work environment with high levels of employee satisfaction and low levels of turnover. Innovativeness can be gauged by considering how many new products or services the organization has developed in the last year and how many patents the firm has obtained.

Similarly, individuals should consider whether their attitudes and behaviors are consistent with the five dimensions of EO. Is an employee making decisions that focus on competitors? Does the employee provide executives with new ideas for products or processes that might create value for the organization? Is the employee making proactive as opposed to reactive decisions? Each of these questions will aid employees in understanding how they can help to support EO within their organizations.

Key Takeaway

- Building an entrepreneurial orientation can be valuable to organizations and individuals alike in identifying and seizing new opportunities. Entrepreneurial orientation consists of five dimensions: (1) autonomy, (2) competitive aggressiveness, (3) innovativeness, (4) proactiveness, and (5) risk taking.

Exercises

1. Can you name three firms that have suffered because of lack of an entrepreneurial orientation?
2. Identify examples of each dimension of entrepreneurial orientation other than the examples offered in this section.
3. How does developing an entrepreneurial orientation have implications for your future career choices?
4. How could you apply the dimensions of entrepreneurial orientation to a job search?

References

- Certo, S. T., Connelly, B., & Tihanyi, L. 2008. Managers and their not-so-rational decisions. *Business Horizons*, 51(2), 113–119.
- Certo, S. T., Moss, T. W., & Short, J. C. 2009. Entrepreneurial orientation: An applied perspective. *Business Horizons*, 52, 319–324.
- Choi, A. S. 2008, April 16. PCI builds telecommunications in Iraq. *Bloomberg Businessweek*. Retrieved from http://www.businessweek.com/magazine/content/08_64/s0804065916656.htm.
- Lumpkin, G. T., & Dess, G. G. 1996. Clarifying the entrepreneurial orientation construct and linking it to performance. *Academy of Management Review*, 21, 135–172.
- Simon, M., Houghton, S. M., & Aquino, K. 2000. Cognitive biases, risk perception, and venture formation: How individuals decide to start companies. *Journal of Business Venturing*, 14, 113–134.

2.6 Conclusion

This chapter explains several challenges that executives face in attempting to lead their organizations strategically. Executives must ensure that their organizations have visions, missions, and goals in place that help move these organizations forward. Measures and referents for assessing performance must be thoughtfully chosen. Some executives become celebrities, thereby creating certain advantages and disadvantages for themselves and for their firms. Finally, executives must monitor the degree of entrepreneurial orientation present within their organizations and make adjustments when necessary. When executives succeed at leading strategically, an organization has an excellent chance of success.

Exercises

1. Divide your class into four or eight groups, depending on the size of the class. Assign each group to develop arguments that one of the key issues discussed in this chapter (vision, mission, goals; assessing organizational performance; CEO celebrity; entrepreneurial orientation) is the most important within organizations. Have each group present their case, and then have the class vote individually for the winner. Which issue won and why?
2. This chapter discussed Howard Schultz and Starbucks on several occasions. Based on your reading of the chapter, how well has Schultz done in dealing with setting a vision, mission, and goals, assessing organizational performance, CEO celebrity, and entrepreneurial orientation?
3. Write a vision and mission for an organization or firm that you are currently associated with. How could you use the balanced scorecard to assess how well that organization is fulfilling the mission you wrote?

Chapter 3: Evaluating the External Environment

Chapter 3: Evaluating the External Environment

3.1 Evaluating the External Environment

3.2 The Relationship between an Organization and Its Environment

3.3 Evaluating the General Environment

3.4 Evaluating the Industry

3.5 Mapping Strategic Groups

3.6 Conclusion

3.1 Evaluating the External Environment

Learning Objectives

After reading this chapter, you should be able to understand and articulate answers to the following questions:

1. What is the general environment and why is it important to organizations?
2. What are the features of Porter's five forces industry analysis?
3. What are strategic groups and how are they useful to evaluating the environment?

Subway Is on a Roll

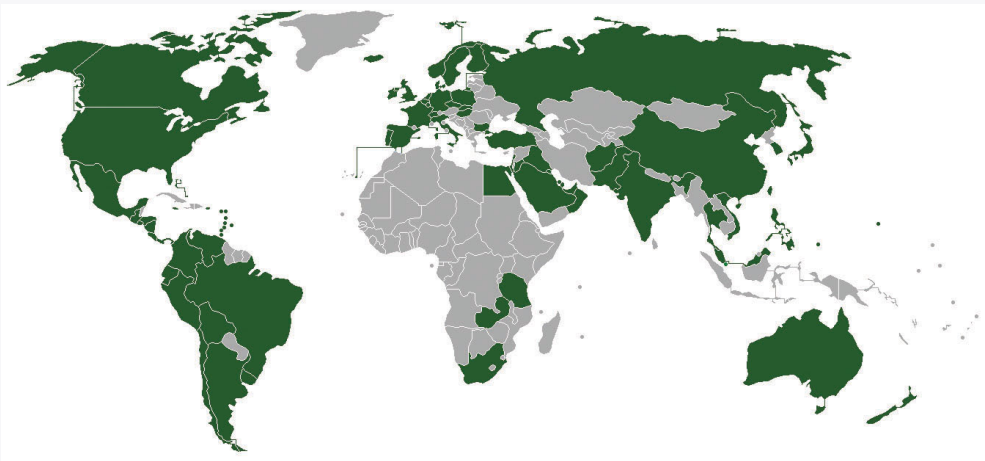

As shown in the highlighted countries, Subway is well on its way to building a worldwide sandwich empire.

[Wikimedia Commons](#) – CC BY-SA 3.0.

Many observers were stunned in March 2011 when news broke that Subway had surpassed McDonald's as the biggest restaurant chain in the world. At the time of the announcement, Subway had 33,749 units under its banner while McDonald's had 32,737 (Kingsley, 2011). Despite its meteoric growth, many opportunities remained. In China, for example, Subway had fewer than two hundred stores. In contrast, China hosts more than 3,200 Kentucky Fried Chicken stores. Overall, Subway was on a roll, and this success seemed likely to continue.

How had Subway surpassed a global icon like McDonald's? One key factor was Subway's efforts to provide and promote healthy eating options. This emphasis took hold in the late 1990s when the American public became captivated by college student Jared Fogle. As a freshman at Indiana University in 1998, the 425 pound Fogle

decided to try to lose weight by walking regularly and eating a diet consisting of Subway subs. Amazingly, Fogle dropped 245 pounds by February of 1999.

Subway executives knew that a great story had fallen into their laps. They decided to feature Fogle in Subway's advertising and soon he was a well-known celebrity. In 2007, Fogle met with President Bush about nutrition and testified before the US Congress about the need for healthier snack options in schools. Today, Fogle is the face of Subway and one of the few celebrities that are instantly recognizable based on his first name alone. Much like Beyoncé and Oprah, you can mention "Jared" to almost anyone in America and that person will know exactly of whom you are speaking. Subway's line of Fresh Fit sandwiches is targeted at prospective Jareds who want to improve their diets.

Because American diets contain too much salt, which can cause high blood pressure, salt levels in restaurant food are attracting increased scrutiny. Subway responded to this issue in April 2011 when its outlets in the United States reduced the amount of salt in all its sandwiches by at least 15 percent without any alteration in taste. The Fresh Fit line of sandwiches received a more dramatic 28 percent reduction in salt. These changes were enacted after customers of Subway's outlets in New Zealand and Australia embraced similar adjustments. Although the new sandwich recipes cost slightly more than the old ones, Subway plans to absorb these costs rather than raising their prices (Riley, 2011). This may be a wise strategy for retaining customers, who have become very price sensitive because of the ongoing uncertainty surrounding the American economy and the high unemployment.

References

Kingsley, P. 2011, March 9. How a sandwich franchise ousted McDonald's. *The Guardian*. Retrieved from <http://www.guardian.co.uk/lifeandstyle/2011/mar/09/subway-biggest-fast-food-chain>.

Riley, C. 2011, April. Subway lowers salt in its sandwiches. *CNNMoney*. Retrieved from http://money.cnn.com/2011/04/18/news/companies/subway_salt/index.htm.

3.2 The Relationship between an Organization and Its Environment

Learning Objectives

1. Define the environment in the context of business.
2. Understand how an organization and its environment affect each other.
3. Learn the difference between the general environment and the industry.

What Is the Environment?

For any organization, the **environment** consists of the set of external conditions and forces that have the potential to influence the organization. In the case of Subway, for example, the environment contains its customers, its rivals such as McDonald's and Kentucky Fried Chicken, social trends such as the shift in society toward healthier eating, political entities such as the US Congress, and many additional conditions and forces.

It is useful to break the concept of the environment down into two components. The **general environment (or macroenvironment)** includes overall trends and events in society such as social trends, technological trends, demographics, and economic conditions. The **industry (or competitive environment)** consists of multiple organizations that collectively compete with one another by providing similar goods, services, or both.

Every action that an organization takes, such as raising its prices or launching an advertising campaign, creates some degree of changes in the world around it. Most organizations are limited to influencing their industry. Subway's move to cut salt in its sandwiches, for example, may lead other fast-food firms to revisit the amount of salt contained in their products. A few organizations wield such power and influence that they can shape some elements of the general environment. While most organizations simply react to major technological trends, for example, the actions of firms such as Intel, Microsoft, and Apple help create these trends. Some aspects of the general environment, such as demographics, simply must be taken as a given by all organizations. Overall, the environment has a far greater influence on most organizations than most organizations have on the environment.

Why Does the Environment Matter?

Understanding the environment that surrounds an organization is important to the executives in charge of the organizations. There are several reasons for this. First, the environment provides resources that an organization needs in order to create goods and services. In the seventeenth century, British poet John Donne famously noted that "no man is an island." Similarly, it is accurate to say that no organization is self-sufficient. As the human body must consume oxygen, food, and water, an organization needs to take in resources such as labor, money, and raw materials from outside its boundaries. Subway, for example, simply would cease to exist without the contributions of the franchisees that operate its stores, the suppliers that provide food and other necessary inputs, and the customers who provide Subway with money through purchasing its products. An organization cannot survive without the support of its environment.

Second, the environment is a source of opportunities and threats for an organization. **Opportunities** are events and trends that create chances to improve an organization's performance level. In the late 1990s, for example, Jared Fogle's growing fame created an opportunity for Subway to position itself as a healthy alternative to traditional fast-

food restaurants. **Threats** are events and trends that may undermine an organization's performance. Subway faces a threat from some upstart restaurant chains. Saladworks, for example, offers a variety of salads that contain fewer than five hundred calories. Noodles and Company offers a variety of sandwiches, pasta dishes, and salads that contain fewer than four hundred calories. These two firms are much smaller than Subway, but they could grow to become substantial threats to Subway's positioning as a healthy eatery.

Executives must also realize that virtually any environmental trend or event is likely to create opportunities for some organizations and threats for others. This is true even in extreme cases. In addition to horrible human death and suffering, the March 2011 earthquake and tsunami in Japan devastated many organizations, ranging from small businesses that were simply wiped out to corporate giants such as Toyota whose manufacturing capabilities were undermined. As odd as it may seem, however, these tragic events also opened up significant opportunities for other organizations. The rebuilding of infrastructure and dwellings requires concrete, steel, and other materials. Japanese concrete manufacturers, steelmakers, and construction companies are likely to be very busy in the years ahead.



Natural disasters devastate many organizations.

Kim Seng – [Monthly Newsletter – November 2011](#) – CC BY-NC-ND 2.0.

Third, the environment shapes the various strategic decisions that executives make as they attempt to lead their organizations to success. The environment often places important constraints on an organization's goals, for example. A firm that sets a goal of increasing annual sales by 50 percent might struggle to achieve this goal during an economic recession or if several new competitors enter its business. Environmental conditions also need to be taken into account when examining whether to start doing business in a new country, whether to acquire another company, and whether to launch an innovative product, to name just a few.

Key Takeaway

- An organization's environment is a major consideration. The environment is the source of resources that the organizations needs. It provides opportunities and threats, and it influences the various strategic decisions that executives must make.

Exercises

1. What are the three reasons that the environment matters?
2. Which of these three reasons is most important? Why?
3. Can you identify an environmental trend that no organizations can influence?

3.3 Evaluating the General Environment

Learning Objectives

1. Explain how PESTEL analysis is useful to organizations.
2. Be able to offer an example of each of the elements of the general environment.

The Elements of the General Environment: PESTEL Analysis

An organization's environment includes factors that it can readily affect as well as factors that largely lay beyond its influence. The latter set of factors are said to exist within the general environment. Because the general environment often has a substantial influence on an organization's level of success, executives must track trends and events as they evolve and try to anticipate the implications of these trends and events.

PESTEL analysis is one important tool that executives can rely on to organize factors within the general environment and to identify how these factors influence industries and the firms within them. PESTEL is an anagram, meaning it is a word that created by using parts of other words. In particular, PESTEL reflects the names of the six segments of the general environment: (1) political, (2) economic, (3) social, (4) technological, (5) environmental, and (6) legal. Wise executives carefully examine each of these six segments to identify major opportunities and threats and then adjust their firms' strategies accordingly ([Table 3.1 "PESTEL"](#)).

Table 3.1 PESTEL

Examining the general environment involves gaining an understanding of key factors and trends in broader society. PESTEL analysis is a popular framework for organizing these factors and trends and isolating how they influence industries and the firms within them. Below we describe each of the six dimensions associated with PESTEL analysis: political, economic, social, technological, environmental, and legal.

P	Political factors include elements such as tax policies, changes in trade restrictions and tariffs, and the stability of governments.
E	Economic factors include elements such as interest rates, inflation rates, gross domestic product, unemployment rates, levels of disposable income, and the general growth or decline of the economy.
S	Social factors include trends in demographics such as population size, age, and ethnic mix, as well as cultural trends such as attitudes toward obesity and consumer activism.
T	Technological factors include, for example, changes in the rate of new product development, increases in automation, and advancements in service industry delivery.
E	Environmental factors include, for example, natural disasters and weather patterns.
L	Legal factors include laws involving issues such as employment, health and safety, discrimination, and antitrust.

P Is for "Political"

The [political segment](#) centers on the role of governments in shaping business. This segment includes elements such as tax policies, changes in trade restrictions and tariffs, and the stability of governments ([Table 3.2 "Political Factors"](#)).

Immigration policy is an aspect of the political segment of the general environment that offers important implications for many different organizations. What approach to take to illegal immigration into the United States from Mexico has been a hotly debated dilemma. Some hospital executives have noted that illegal immigrants put a strain on the health care system because immigrants seldom can pay for medical services and hospitals cannot by law turn them away from emergency rooms.

Table 3.2 Political Factors

Examples of several key trends representing political factors in the general environment are illustrated below.

The extent to which companies developing clean energy sources should be subsidized by the government versus being left on their own to compete with providers of traditional energy sources is currently a hotly contested political issue.

The use of child labor was once commonplace in the United States now firms face political scrutiny when using overseas suppliers that employ child labor.

The word *tariff* derived from an Arabic word meaning “fees to be paid.” By levying tariffs and implementing other trade restrictions, governments can — to some extent — protect domestic firms from international competition.

The stability of the US government provides a source of confidence for foreign firms who want to do business in the United States. Countries that face frequent regime change and political turmoil have a harder time attracting foreign investments.

One of the most important duties of elected officials in the United States is to debate and set new tax policies.



Proposals to provide support to businesses are often featured within political campaigns.

Meanwhile, farmers argue that a tightening of immigration policy would be harmful because farmers rely heavily on cheap labor provided by illegal immigrants. In particular, if farmers were forced to employ only legal workers, this would substantially increase the cost of vegetables. Restaurant chains such as Subway would then pay higher prices for lettuce, tomatoes, and other perishables. Subway would then have to decide whether to absorb these costs or pass them along to customers by charging more for subs. Overall, any changes in immigration policy will have implications for hospitals, farmers, restaurants, and many other organizations.

E Is for “Economic”

The **economic segment** centers on the economic conditions within which organizations operate. It includes elements such as interest rates, inflation rates, gross domestic product, unemployment rates, levels of disposable income, and the general growth or decline of the economy (Table 3.3 “Economic Factors”). The economic crisis of the late 2000s has had a tremendous negative effect on a vast array of organizations. Rising unemployment discouraged consumers from purchasing expensive, nonessential goods such as automobiles and television sets. Bank failures during the economic crisis led to a dramatic tightening of credit markets. This dealt a huge blow to home builders, for example, who saw demand for new houses plummet because mortgages were extremely difficult to obtain.

Table 3.3 Economic Factors

Examples of several key trends representing economic factors in the general environment are illustrated below.

Housing starts is an economic indicator that measures the number of houses, apartments, and condos on which new construction has been started. Because construction involves a wide array of industries—concrete, steel, wood, drywall, plumbing, banks, and many others—housing starts are a carefully watched measure of economic conditions.

Gross domestic product (GDP) refers to the market value of goods and services within a country produced in a given time period and serves as a rough indicator of a country’s standard of living. The United States has a much larger GDP than China, but China has enjoyed a much higher rate of GDP growth in recent years.

The Federal Reserve System (commonly referred to as “The Fed”) is the United States’ central banking system. The Fed attempts to strengthen the economy through its decisions, such as setting short-term interest rates.

Discretionary income refers to the amount of money individuals have to spend after all necessary bills are paid. As discretionary income increases, firms such as boutique clothing retailers that sell nonessential goods and services are more likely to prosper.

Some businesses, however, actually prospered during the crisis. Retailers that offer deep discounts, such as Dollar General and Walmart, enjoyed an increase in their customer base as consumers sought to find ways to economize. Similarly, restaurants such as Subway that charge relatively low prices gained customers, while high-end restaurants such as Ruth’s Chris Steak House worked hard to retain their clientele.

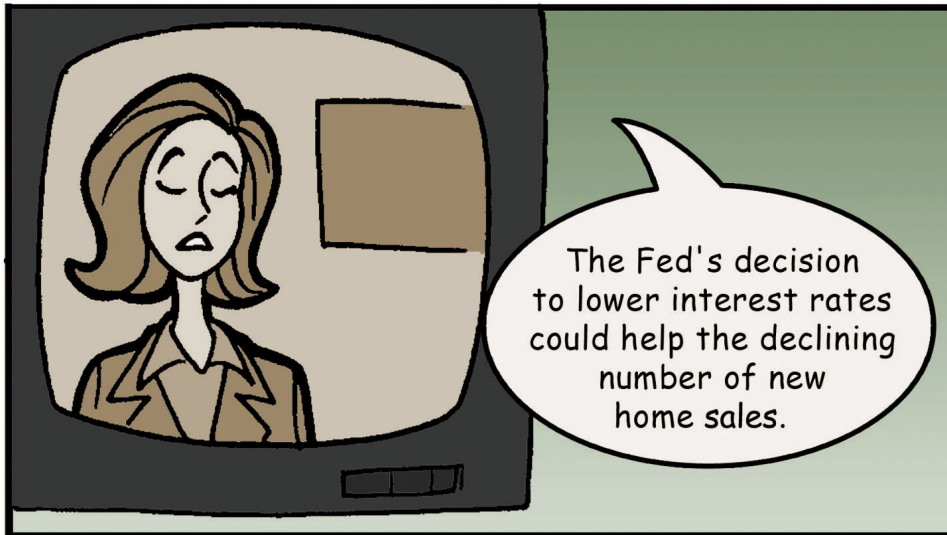

Decisions about interest rates made by the Federal Reserve create opportunities for some organizations and threats for others.

S Is for "Social"

A generation ago, ketchup was an essential element of every American pantry and salsa was a relatively unknown product. Today, however, food manufacturers sell more salsa than ketchup in the United States. This change reflects the **social segment** of the general environment. Social factors include trends in demographics such as population size, age, and ethnic mix, as well as cultural trends such as attitudes toward obesity and consumer activism (Table 3.4 "Social Factors"). The exploding popularity of salsa reflects the increasing number of Latinos in the United States over time, as well as the growing acceptance of Latino food by other ethnic groups.

Table 3.4 Social Factors

Examples of several key trends representing social factors in the general environment are illustrated below.

The rise of upscale cupcake outlets reflects a current trend in American eateries: pricey specialty stores are very popular among some consumers.

Hunters remain a powerful force in American society, but their ranks shrunk by 10% between 1996 and 2006. Wildlife agencies worry about the loss of license-fee revenue will affect their ability to manage land and water resources, and lower levels of demand for their products threaten the success of gun makers.

In the 1800s, most American couples raised many children. Farmers, for example, took this approach because it supplied labor that small farms needed in order to operate. Today, most families are smaller.

One in three Americans is obese, due in part to the increasing prevalence of fast-food restaurants and the popularity of sedentary activities such as playing video games.

Hemline theory contends that women's skirt lengths predict stock market increases and declines. The idea was born in the 1920s when economist George Taylor noticed that many women raised their skirts to reveal their silk stockings when times were good, but lowered their skirts to hide the fact that they weren't wearing stockings when times were tough.

The tendency to collect material items while being reluctant to throw them away has led to a rise in self-storage outlets as well as awareness of a hoarding epidemic.

Sometimes changes in the social segment arise from unexpected sources. Before World War II, the American workforce was overwhelmingly male. When millions of men were sent to Europe and Asia to fight in the war, however, organizations had no choice but to rely heavily on female employees. At the time, the attitudes of many executives toward women were appalling. Consider, for example, some of the advice provided to male supervisors of female workers in the July 1943 issue of *Transportation Magazine*:¹

- Older women who have never contacted the public have a hard time adapting themselves and are inclined to be cantankerous and fussy. It's always well to impress upon older women the importance of friendliness and courtesy.
- General experience indicates that "husky" girls—those who are just a little on the heavy side—are more even tempered and efficient than their underweight sisters.
- Give every girl an adequate number of rest periods during the day. You have to make some allowances for feminine psychology. A girl has more confidence and is more efficient if she can keep her hair tidied, apply fresh lipstick and wash her hands several times a day.

The tremendous contributions of female workers during the war contradicted these awful stereotypes. The main role of women who assembled airplanes, ships, and other war materials was to support the military, of course, but their efforts also changed a lot of male executives' minds about what females could accomplish within organizations if provided with opportunities. Inequities in the workplace still exist today, but modern attitudes among men toward women in the workplace are much more enlightened than they were in 1943.



Women's immense contributions to the war effort during World War II helped create positive social changes in the ensuing decades.

[Wikimedia Commons](#) – public domain.

Beyond being a positive social change, the widespread acceptance of women into the workforce has created important opportunities for certain organizations. Retailers such as Talbot's and Dillard's sell business attire to women. Subway and other restaurants benefit when the scarceness of time lead dual income families to purchase take-out meals rather than cook at home.



A surprising demographic trend is that both China and India have more than twice as many English-speaking college graduates each year than does the United States.

T Is for “Technological”

The [technological segment](#) centers on improvements in products and services that are provided by science. Relevant factors include, for example, changes in the rate of new product development, increases in automation, and advancements in service industry delivery ([Table 3.5 “Technological Factors”](#)). One key feature of the modern era is the ever-increasing pace of technological innovation. In 1965, Intel cofounder Gordon E. Moore offered an idea that has come to be known as Moore’s law. Moore’s law suggests that the performance of microcircuit technology roughly doubles every two years. This law has been very accurate in the decades since it was offered.

Table 3.5 Technological Factors

Examples of several key trends representing technological factors in the general environment are illustrated below.

Unsuccessful technological innovations such as Smell-O-Vision (a system that would release different odors that matched the events shown on screen) highlight the risk associated with the technology sector. Image watching a show on horse stables!

The adoption rate of new technology is closely monitored by market research firms. The Internet reached 50 million users in 4 years. To reach the same number of users took 13 years for TV and 38 years for radio.

The dramatic changes in the video game industry over the past 25 years highlight the need to constantly adapt to technological factors to maintain market leadership. Once-mighty Atari has given way to current leaders Sony, Nintendo, and Microsoft.

Moore's law suggests that the performance of microcircuit technology roughly doubles every two years.

The amount of government spending for research and development affects numerous industries. The government's decision to dramatically scale back moon-based space programs may reduce the pace of scientific breakthroughs.

One implication of Moore's law is that over time electronic devices can become smaller but also more powerful. This creates important opportunities and threats in a variety of settings. Consider, for example, photography. Just a decade ago, digital cameras were relatively large and they produced mediocre images. With each passing year, however, digital cameras have become smaller, lighter, and better. Today, digital cameras are, in essence, minicomputers, and electronics firms such as Panasonic have been able to establish strong positions in the market. Meanwhile, film photography icon Kodak has been forced to abandon products that had been successful for decades. In 2005, the firm announced that it would stop producing black-and-white photographic paper. Four years later, Kodachrome color film was phased out.

Successful technologies are also being embraced at a much faster rate than in earlier generations. The Internet reached fifty million users in only four years. In contrast, television reached the same number of users in thirteen years while it took radio thirty-eight years. This trend creates great opportunities for organizations that depend on emerging technologies. Writers of applications for Apple's iPad and other tablet devices, for example, are able to target a fast-growing population of users. At the same time, organizations that depend on technologies that are being displaced must be aware that consumers could abandon them at a very rapid pace. As more and more Internet users rely on Wi-Fi service, for example, demand for cable modems may plummet.



Moore's law explains how today's iPhone can be one hundred times faster, one hundred times lighter, and ten times less expensive than a "portable" computer built in the 1980s.

[Wikimedia Commons](#) – CC BY 2.0.

Although the influence of the technological segment on technology-based companies such as Panasonic and Apple is readily apparent, technological trends and events help to shape low-tech businesses too. In 2009, Subway started a service called Subway Now. This service allows customers to place their orders in advance using text messages and avoid standing in line at the store. By offering customers this service, Subway is also responding to a trend in the general environment's social segment: the need to save time in today's fast-paced society.

E Is for "Environmental"

The [environmental segment](#) involves the physical conditions within which organizations operate. It includes factors such as natural disasters, pollution levels, and weather patterns ([Table 3.6 "Environmental Factors"](#)). The threat of pollution, for example, has forced municipalities to treat water supplies with chemicals. These chemicals increase the safety of the water but detract from its taste. This has created opportunities for businesses that provide better-tasting water. Rather than consume cheap but bad-tasting tap water, many consumers purchase bottled water. Indeed, according to the Beverage Marketing Corporation, the amount of bottled water consumed by the average American increased from 1.6 gallons in 1976 to 28.3 gallons in 2006 (Earth911). At present, roughly one-third of Americans drink bottled water regularly.

Table 3.6 Environmental Factors

Examples of several key trends representing environmental factors in the general environment are illustrated below.

The Subaru automotive plant in Lafayette, Indiana, was the first auto manufacturing facility to achieve zero landfill status.

Debate has raged over climate change in recent years. To the extent that more policy makers and consumers believe that human activity is increasing temperatures on the Earth, opportunities could increase for solar energy companies.

Individuals embracing the three Rs of green living—reduce, reuse, recycle—has fueled new business concepts such as Recycle Match, a firm that brings together waste products with businesses that need those materials.

Concern about the environmental effects of burning fossil fuels has contributed to the growing popularity of scooters.

The increase in the number of food cooperatives reflects growing interest in sustainable, natural foods that are produced with a high degree of social responsibility.

As is the case for many companies, bottled water producers not only have benefited from the general environment but also have been threatened by it. Some estimates are that 80 percent of plastic bottles end up in landfills. This has led some socially conscious consumers to become hostile to bottled water. Meanwhile, water filtration systems offered by Brita and other companies are a cheaper way to obtain clean and tasty water. Such systems also hold considerable appeal for individuals who feel the need to cut personal expenses due to economic conditions. In sum, bottled water producers have been provided opportunities by the environmental segment of the general environment (specifically, the spread of poor-tasting water to combat pollution) but are faced with threats from the social segment (the social conscience of some consumers) and the economic segment (the financial concerns of other consumers).



A key trend within the environmental segment is an increasing emphasis on conserving fossil fuels.

L Is for “Legal”

The **legal segment** centers on how the courts influence business activity. Examples of important legal factors include employment laws, health and safety regulations, discrimination laws, and antitrust laws (Table 3.7 “Legal Factors”).

Intellectual property rights are a particularly daunting aspect of the legal segment for many organizations. When a studio such as Pixar produces a movie, a software firm such as Adobe revises a program, or a video game company such as Activision devises a new game, these firms are creating intellectual property. Such firms attempt to make profits by selling copies of their movies, programs, and games to individuals. Piracy of intellectual property—a process wherein illegal copies are made and sold by others—poses a serious threat to such profits. Law enforcement agencies and courts in many countries, including the United States, provide organizations with the necessary legal mechanisms to protect their intellectual property from piracy.

Table 3.7 Legal Factors

Examples of several key trends representing legal factors in the general environment are illustrated below.

Electronic recycling laws are creating opportunities for “green collar jobs.” A recent Missouri law, for example, requires computer electronic equipment manufacturers to develop and implement recycling plans.
The Sherman Antitrust Act of 1890 limits cartels and monopolies in the United States. Senator John Sherman was the principal author of this legislation.
In the United States, it is illegal to discriminate against anyone based on age, race, religion, gender or disability.
The role of the Occupational Safety and Health Administration (OSHA) is to prevent work-related injuries, diseases, and fatalities by enforcing standards for workplace safety and health.
Laws requiring that nutrition information must appear on the packaging of most food products are intended to protect consumers and help them make informed choices.

In other countries, such as China, piracy of intellectual property is quite common. Three other general environment segments play a role in making piracy a major concern. First, in terms of the social segment, China is the most populous country in the world. Second, in terms of the economic segment, China’s affluence is growing rapidly. Third, in terms of the technological segment, rapid advances in computers and communication have made piracy easier over time. Taken together, these various general environment trends lead piracy to be a major source of angst for firms that rely on intellectual property to deliver profits.

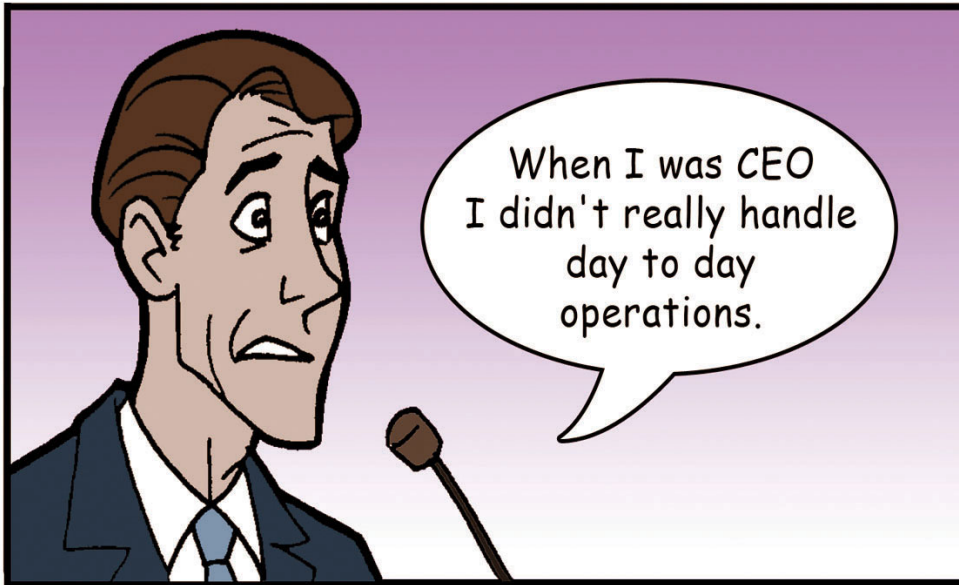

A key legal trend in recent years is forcing executives to have greater accountability for corporate misdeeds via laws such as the 2002 Sarbanes-Oxley Act.

Reproduced with permission from

Key Takeaway

- To transform an avocado into guacamole, a chef may choose to use a mortar and pestle. A mortar is a mashing device that is shaped like a baseball bat, while a pestle is a sturdy bowl within which the mashing takes place. Similarly, PESTEL reflects the general environment factors—political, economic, social, technological, environmental, and legal—that can crush an organization. In many cases, executives can prevent such outcomes by performing a PESTEL analysis to diagnose where in the general environment important opportunities and threats arise.

Just as a mortar and pestle are used to crush food, PESTEL can crush an organization.

[Wikimedia Commons](#) – public domain.

Exercises

1. What does each letter of PESTEL mean?
2. Using a recent news article, identify a trend that has a positive and negative implication for a particular industry.



SONY DSC

3. Can you identify a general environment trend that has positive implications for nursing homes but negative implications for diaper makers?
4. Are all six elements of PESTEL important to every organization? Why or why not?
5. What is a key trend for each letter of PESTEL and one industry or firm that would be affected by that trend?

¹1943 guide to hiring women. 2007, September–October. *Savvy & Sage*, p. 16.

References

Earth911, Plastic recycling facts. earth911.com. Retrieved from <http://earth911.com/recycling/plastic/plastic-bottle-recycling-facts>

3.4 Evaluating the Industry

Learning Objectives

1. Explain how five forces analysis is useful to organizations.
2. Be able to offer an example of each of the five forces.

Table 3.8 Industry Analysis

Understanding the dynamics that shape how much profit potential exists within an industry is key to knowing how likely a particular firm is to succeed within the industry. There are five key forces that determine the profitability of a particular industry.

POTENTIAL ENTRANTS are firms that are not currently considered viable competitors in the industry but that may become viable competitors in the future. For example, Tesla Motors' production of electric vehicles poses a threat to displace the traditional powers in the auto industry, and Chinese auto makers are rumored to be eyeing the US market.

SUPPLIERS to the auto industry include firms such as Lear Corporation who produces auto interior systems.

INDUSTRY COMPETITORS in the auto industry include firms such as Ford, Chrysler, and GM.

BUYERS are those firms that buy directly from the industry such as automobile dealerships. Automakers also have to pay careful attention to end users, of course, such as individual drivers and rental car agencies.

SUBSTITUTES for the auto industry's products include bicycles and mass transit. Luckily for automakers competing in the US market, Americans are notoriously reluctant to embrace these substitutes.

The Purpose of Five Forces Analysis

Visit the executive suite of any company and the chances are very high that the chief executive officer and her vice presidents are relying on [five forces analysis](#) to understand their industry. Introduced more than thirty years ago by Professor Michael Porter of the Harvard Business School, five forces analysis has long been and remains perhaps the most popular analytical tool in the business world ([Table 3.8 "Industry Analysis"](#)).

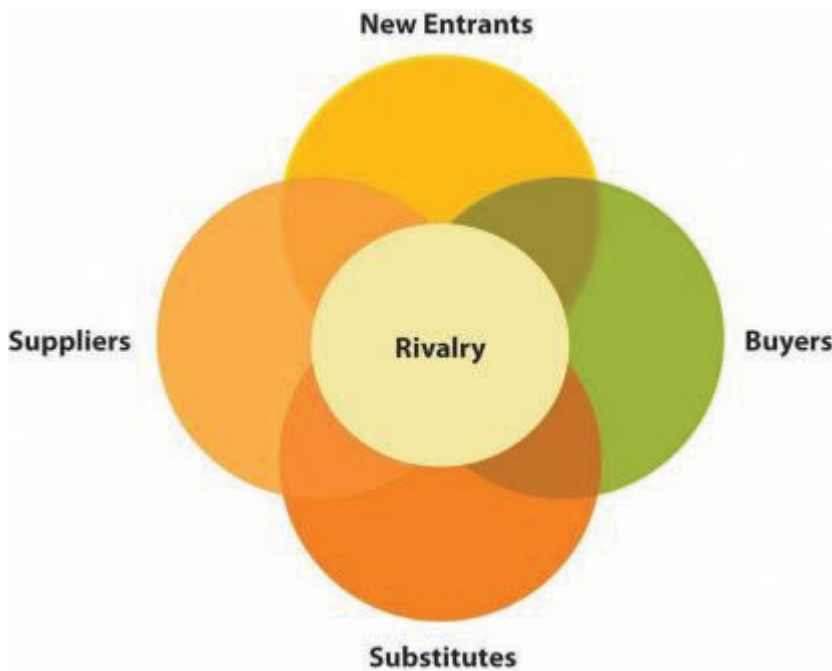

Porter's Five Forces

The purpose of five forces analysis is to identify how much profit potential exists in an industry. To do so, five forces analysis considers the interactions among the competitors in an industry, potential new entrants to the industry, substitutes for the industry's offerings, suppliers to the industry, and the industry's buyers (Porter, 1979). If none of these five forces works to undermine profits in the industry, then the profit potential is very strong. If all the forces work to undermine profits, then the profit potential is very weak. Most industries lie somewhere in between these extremes. This could involve, for example, all five forces providing firms with modest help or two forces encouraging profits while the other three undermine profits. Once executives determine how much profit potential exists in an industry, they can then decide what strategic moves to make to be successful. If the situation looks bleak, for example, one possible move is to exit the industry.

The Rivalry among Competitors in an Industry

The **competitors** in an industry are firms that produce similar products or services. Competitors use a variety of moves such as advertising, new offerings, and price cuts to try to outmaneuver one another to retain existing buyers and to attract new ones. Because competitors seek to serve the same general set of buyers, rivalry can become intense (Table 3.9 "Rivalry"). Subway faces fierce competition within the restaurant business, for example. This is illustrated by a quote from the man who built McDonald's into a worldwide icon. Former CEO Ray Kroc allegedly once claimed that "if any of my competitors were drowning, I'd stick a hose in their mouth." While this sentiment was (hopefully) just a figure of speech, the announcement in March 2011 that Subway had surpassed McDonald's in terms of numbers of stores might lead the hostility of McDonald's toward its rival to rise.

Table 3.9 Rivalry

High levels of rivalry tend to reduce the profit potential of an industry. A number of characteristics that affect the intensity of the rivalry among competitors are illustrated below.

Rivalry among existing competitors tends to be high to the extent that...

Competitors are numerous or are roughly equal in size and power.	No one firm rules the industry, and cutthroat moves are likely as firms jockey for position.
The growth rate of the industry is slow.	A shortage of new customers leads firms to steal each other's customers.
Competitors are not differentiated from each other.	This forces firms to compete based on price rather than based on the uniqueness of their offerings.
Fixed costs in the industry are high.	These costs must be covered, even if it means slashing prices in order to do so.
Exit barriers are high.	Firms must stay and fight rather than leaving the industry gracefully.
Excess capacity exists in the industry.	When too much of a product is available, firms must work hard to earn sales.
Capacity must be expanded in large increments to be efficient.	The high costs of adding these increments needs to be covered.
The product is perishable	Firms need to sell their wares before they spoil and become worthless.

Understanding the intensity of rivalry among an industry's competitors is important because the degree of intensity helps shape the industry's profit potential. Of particular concern is whether firms in an industry compete based on price. When competition is bitter and cutthroat, the prices competitors charge—and their profit margins—tend to go down. If, on the other hand, competitors avoid bitter rivalry, then price wars can be avoided and profit potential increases.

Every industry is unique to some degree, but there are some general characteristics that help to predict the likelihood that fierce rivalry will erupt. Rivalry tends to be fierce, for example, to the extent that the growth rate of demand for the industry's offerings is low (because a lack of new customers forces firms to compete more for existing customers), fixed costs in the industry are high (because firms will fight to have enough customers to cover these costs), competitors are not differentiated from one another (because this forces firms to compete based on price rather than based on the uniqueness of their offerings), and **exit barriers** in the industry are high (because firms do not have the option of leaving the industry gracefully). Exit barriers can include emotional barriers, such as the bad publicity associated with massive layoffs, or more objective reasons to stay in an industry, such as a desire to recoup considerable costs that might have been previously spent to enter and compete.

Table 3.10 Industry Concentration

Industry concentration refers to the extent to which large firms dominate an industry. Buyers and suppliers generally have more bargaining power when they are from concentrated industries. This is because the firms that do business with them have fewer options when seeking buyers and suppliers. One popular way to measure industry concentration is via the percentage of total industry output that is produced by the four biggest competitors. Below are examples of industries that have high (80%-100%), medium (50%-79%), and low (below 50%) levels of concentration.

High-Concentration Industries
Circuses (89%) and Breakfast cereal manufacturing (85%)
Medium-Concentration Industries
Flight training (52%) and Sugar manufacturing (60%)
Low-Concentration (or “Fragmented”) Industries
Full-service restaurants (9%), Legal services (3%), Truck driving schools (27%), and Telephone call centers (22%)

Industry concentration is an important aspect of competition in many industries. Industry concentration is the extent to which a small number of firms dominate an industry (Table 3.10 “Industry Concentration”). Among circuses, for example, the four largest companies collectively own 89 percent of the market. Meanwhile, these companies tend to keep their competition rather polite. Their advertising does not lampoon one another, and they do not put on shows in the same city at the same time. This does not guarantee that the circus industry will be profitable; there are four other forces to consider as well as the quality of each firm’s strategy. But low levels of rivalry certainly help build the profit potential of the industry.

In contrast, the restaurant industry is fragmented, meaning that the largest rivals control just a small fraction of the business and that a large number of firms are important participants. Rivalry in fragmented industries tends to become bitter and fierce. Quiznos, a chain of sub shops that is roughly 15 percent the size of Subway, has directed some of its advertising campaigns directly at Subway, including one depicting a fictional sub shop called “Wrong Way” that bore a strong resemblance to Subway.

Within fragmented industries, it is almost inevitable that over time some firms will try to steal customers from other firms, such as by lowering prices, and that any competitive move by one firm will be matched by others. In the wake of Subway’s success in offering foot-long subs for \$5, for example, Quiznos has matched Subway’s price. Such price jockeying is delightful to customers, of course, but it tends to reduce prices (and profit margins) within an industry. Indeed, Quiznos later escalated its attempt to attract budget-minded consumers by introducing a flatbread sandwich that cost only \$2. Overall, when choosing strategic moves, Subway’s presence in a fragmented industry forces the firm to try to anticipate not only how fellow restaurant giants such as McDonald’s and Burger King will react but also how smaller sub shop chains like Quiznos and various regional and local players will respond.

Table 3.11 New Entrants

The Great Wall of China effectively protected China against potential raiders for centuries. The metaphor of a high wall as a defense against potential entrants is a key element in Porter’s five forces model. Industries with higher barriers to entry are in a safer defensive position than industries with lower barriers. Below we describe several factors that make it difficult for would-be invaders to enter an industry.

Economies of scale – As the number of customers a firm serves increases, the cost of serving each customer tends to decrease. This is because fixed costs—the expenses the firm must pay, such as the loan payments on an automobile factory—are allocated across a larger number of sales. When the firms in an industry enjoy significant economies of scale, new firms struggle to be able to sell their wares at competitive prices.

Capital requirements – The more expensive it is to enter a business, the less likely a new firm is to attempt to enter it. When these capital requirements are substantial (as in the automobile and many other manufacturing industries), existing competitors have less fear of new firms entering their market. It is simply very difficult to gather up enough cash to enter certain businesses.

Access to distribution channels – The ability to get goods and services to customers can pose a significant challenge to would-be newcomers. In the auto industry, for example, a new firm would struggle to match the network of dealerships enjoyed by Ford, GM, and other auto makers.

Government policy – Decisions made by governments can deter or encourage potential new entrants. In 2009, the U.S. government kept GM afloat via a massive infusion of cash. Had GM been left to die instead, this could have opened the door for a new company to enter the industry, perhaps by buying some of GM’s factories.

Differentiation – Auto makers spend millions of dollars each year on advertising in order to highlight the unique features of their cars. A new entrant would struggle to match the differentiation that years of advertising have created for various brands.

Switching costs – Switching costs endured by consumers are one of the challenges facing the makers of alternative fuel vehicles. A massive number of gas stations and repair shops are in place to support gasoline-powered cars, but few facilities can recharge or fix electric cars. At present, few consumers are willing to live with the significant hassles and inconvenience that arise when purchasing an alternative fuel vehicle.

Expected retaliation – New firms must be concerned about whether current industry members will aggressively respond to them entering the market. If a firm succeeded in entering the automobile business, for example, existing companies might slash their prices in order to keep their market share intact.

Cost advantages independent of size – Proprietary technology, access to raw materials, and desirable geographic location are all examples of cost advantages not directly associated with size (and economies of scale). In the auto industry, the decades of engineering experience possessed by the major auto makers is an example of such an advantage. A new entrant would struggle to duplicate this know-how at any price.

The Threat of Potential New Entrants to an Industry

Competing within a highly profitable industry is desirable, but it can also attract unwanted attention from outside the industry. **Potential new entrants** to an industry are firms that do not currently compete in the industry but may in the future (Table 3.11 “New Entrants”). New entrants tend to reduce the profit potential of an industry by increasing its competitiveness. If, for example, an industry consisting of five firms is entered by two new firms, this means that seven

rather than five firms are now trying to attract the same general pool of customers. Thus executives need to analyze how likely it is that one or more new entrants will enter their industry as part of their effort to understand the profit potential that their industry offers.

New entrants can join the fray within an industry in several different ways. New entrants can be start-up companies created by entrepreneurs, foreign firms that decide to enter a new geographic area, supplier firms that choose to enter their customers' business, or buyer firms that choose to enter their suppliers' business. The likelihood of these four paths being taken varies across industries. Restaurant firms such as Subway, for example, do not need to worry about their buyers entering the industry because they sell directly to individuals, not to firms. It is also unlikely that Subway's suppliers, such as farmers, will make a big splash in the restaurant industry.



The entry of chicken burger restaurant Oporto into the United States might hurt hamburger restaurants more than it hurts Subway and other sandwich makers.

[Wikimedia Commons](#) – CC BY-SA 4.0.

On the other hand, entrepreneurs launch new restaurant concepts every year, and one or more of these concepts may evolve into a fearsome competitor. Also, competitors based overseas sometimes enter Subway's core US market. In February 2011, Australia-based Oporto opened its first US store in California (Odell, 2011). Oporto operates more than 130 chicken burger restaurants in its home country. Time will tell whether this new entrant has a significant effect on Subway and other restaurant firms. Because a chicken burger closely resembles a hamburger, McDonald's and Burger King may have more to fear from Oporto than does Subway.

Every industry is unique to some degree, but some general characteristics help to predict the likelihood that new entrants will join an industry. New entry is less likely, for example, to the extent that existing competitors enjoy economies of scale (because new entrants struggle to match incumbents' prices), capital requirements to enter the industry are high (because new entrants struggle to gather enough cash to get started), access to distribution channels is limited (because new entrants struggle to get their offerings to customers), governmental policy discourages new entry, differentiation among existing competitors is high (because each incumbent has a group of loyal customers that enjoy its unique features), switching costs are high (because this discourages customers from buying a new entrant's offerings), expected retaliation from existing competitors is high, and cost advantages independent of size exist.

Table 3.12 Substitutes

A substitute teacher is a person who fills in for a teacher. Some substitute teachers are almost as good as the "real" teacher while others are woefully inadequate. In business, the competitors in an industry not only must watch each other, they must keep

an eye on firms in other industries whose products or services can serve as effective substitutes for their offerings. In some cases, substitutes are so effective that they are said to “disrupt” the industry, meaning they kill most or all industry demand. Below we note a number of effective substitutes for particular industries.

Cooking at home can be an effective substitute for eating at restaurants, especially in challenging economic times.

E-mails and faxes are less expensive substitutes for some of the US Postal Service’s offerings. Meanwhile, text messages can serve as substitutes for many e-mails.

Typewriting classes were once common in schools. But once personal computers and printers became widely accepted, the typewriter industry declined dramatically.

Railroads once held almost a monopoly position on freight transportation. However, the rise of the trucking industry reduced demand for the railroad industry’s services.

DIRECTV’s commercials compare the firm’s offerings not only to what its fellow satellite television provider DISH Network provides but also to the offerings of a close substitute—cable television companies.

The Threat of Substitutes for an Industry’s Offerings

Executives need to take stock not only of their direct competition but also of players in other industries that can steal their customers. **Substitutes** are offerings that differ from the goods and services provided by the competitors in an industry but that fill similar needs to what the industry offers (Table 3.12 “Substitutes”). How strong of a threat substitutes are depends on how effective substitutes are in serving an industry’s customers.

At first glance, it could appear that the satellite television business is a tranquil one because there are only two significant competitors—DIRECTV and DISH Network. These two industry giants, however, face a daunting challenge from substitutes. The closest substitute for satellite television is provided by cable television firms, such as Comcast and Charter Communications. DIRECTV and DISH Network also need to be wary of streaming video services, such as Netflix, and video rental services, such as Redbox. The availability of viable substitutes places stringent limits on what DIRECTV and DISH Network can charge for their services. If the satellite television firms raise their prices, customers will be tempted to obtain video programs from alternative sources. This limits the profit potential of the satellite television business.

In other settings, viable substitutes are not available, and this helps an industry’s competitors enjoy profits. Like lightbulbs, candles can provide lighting within a home. Few consumers, however, would be willing to use candles instead of lightbulbs. Candles simply do not provide as much light as lightbulbs. Also, the risk of starting a fire when using candles is far greater than the fire risk of using lightbulbs. Because candles are a poor substitute, lightbulb makers such as General Electric and Siemens do not need to fear candle makers stealing their customers and undermining their profits.



Few consumers would be willing to substitute candles for lightbulbs.

[Wikimedia Commons](#) – CC0 public domain.

The dividing line between which firms are competitors and which firms offer substitutes is a challenging issue for executives. Most observers would agree that, from Subway's perspective, sandwich maker Quiznos should be considered a competitor and that grocery stores such as Kroger offer a substitute for Subway's offerings. But what about full-service restaurants, such as Ruth's Chris Steak House, and "fast causal" outlets, such as Panera Bread? Whether firms such as these are considered competitors or substitutes depends on how the industry is defined. Under a broad definition—Subway competes in the restaurant business—Ruth's Chris and Panera should be considered competitors. Under a narrower definition—Subway competes in the sandwich business—Panera is a competitor and Ruth's Chris is a substitute. Under a very narrow definition—Subway competes in the sub sandwich business—both Ruth's Chris and Panera provide substitute offerings. Thus clearly defining a firm's industry is an important step for executives who are performing a five forces analysis.

Table 3.13 Suppliers

<p>A supplier group is powerful if it is dominated by a few companies or is more concentrated than the industry that it supplies.</p>	<p>The DeBeers Company of South Africa owns the vast majority of diamond mines in the world. This gives the firm great leverage when negotiating with various jewelry produces.</p>
<p>A supplier group is powerful if there is no substitute for what the supplier group provides.</p>	<p>Although artificial diamonds are fine for industrial applications, real diamonds are necessary for jewelry. Any groom who thinks otherwise is playing a risky game indeed.</p>
<p>A supplier group is powerful if industry members rely heavily on suppliers to be profitable.</p>	<p>Computer, cellular phone, and digital appliance manufacturers all rely heavily on suppliers in the microchip manufacturing industry.</p>
<p>A supplier group is powerful if industry members face high costs when changing suppliers.</p>	<p>Most computers installed in university classrooms are PCs. A university that wants to switch to using Apple computers would endure enormous costs in money and labor. This strengthens the position of PC makers a bit when they deal with universities.</p>
<p>A supplier group is powerful if their products are differentiated.</p>	<p>Dolby Laboratories offers top-quality audio systems that are backed by a superb reputation. Firms that make home theater equipment and car stereos have little choice but to buy from Dolby because many consumers simply expect to enjoy Dolby's technology.</p>
<p>A supplier group is powerful if it can credibly threaten to compete (integrate forward) in the industry if motivated.</p>	<p>Before a rental car company drives too hard of a bargain when buying cars from an auto maker, it should remember that Ford used to own Hertz.</p>

The Power of Suppliers to an Industry

Suppliers provide inputs that the firms in an industry need to create the goods and services that they in turn sell to their buyers. A variety of supplies are important to companies, including raw materials, financial resources, and labor (Table 3.13 “Suppliers”). For restaurant firms such as Subway, key suppliers include such firms as Sysco that bring various foods to their doors, restaurant supply stores that sell kitchen equipment, and employees that provide labor.

The relative bargaining power between an industry's competitors and its suppliers helps shape the profit potential of the industry. If suppliers have greater leverage over the competitors than the competitors have over the suppliers, then suppliers can increase their prices over time. This cuts into competitors' profit margins and makes them less likely to be prosperous. On the other hand, if suppliers have less leverage over the competitors than the competitors have over the suppliers, then suppliers may be forced to lower their prices over time. This strengthens competitors' profit margins and makes them more likely to be prosperous. Thus when analyzing the profit potential of their industry, executives must carefully consider whether suppliers have the ability to demand higher prices.

Every industry is unique to some degree, but some general characteristics help to predict the likelihood that suppliers will be powerful relative to the firms to which they sell their goods and services. Suppliers tend to be powerful, for example, to the extent that the suppliers' industry is dominated by a few companies, if it is more concentrated than the industry that it supplies and/or if there is no effective substitute for what the supplier group provides. These circumstances restrict industry competitors' ability to shop around for better prices and put suppliers in a position of strength.

Supplier power is also stronger to the extent that industry members rely heavily on suppliers to be profitable, industry members face high costs when changing suppliers, and suppliers' products are differentiated. Finally, suppliers possess power to the extent that they have the ability to become a new entrant to the industry if they wish. This is a strategy called **forward vertical integration**. Ford, for example, used a forward vertical integration strategy when it purchased rental car company (and Ford customer) Hertz. A difficult financial situation forced Ford to sell Hertz for \$5.6 billion in 2005. But before rental car companies such as Avis and Thrifty drive too hard of a bargain when buying cars from an automaker, their executives should remember that automakers are much bigger firms than are rental car companies. The executives running the automaker might simply decide that they want to enjoy the rental car company's profits themselves and acquire the firm.

Strategy at the Movies

Flash of Genius

When dealing with a large company, a small supplier can get squashed like a bug on a windshield. That is what college professor and inventor Dr. Robert Kearns found out when he invented intermittent windshield wipers in the 1960s and attempted to supply them to Ford Motor Company. As depicted in the 2008 movie *Flash of Genius*, Kearns dreamed of manufacturing the wipers and selling them to Detroit automakers. Rather than buy the wipers from Kearns, Ford replicated the design. An angry Kearns then spent many years trying to hold the firm accountable for infringing on his patent. Kearns eventually won in court, but he paid a terrible personal price along the way, including a nervous breakdown and estrangement from his family. Kearns's lengthy battle with Ford illustrates the concept of bargaining power that is central to Porter's five forces model. Even though Kearns created an exceptional new product, he had little leverage when dealing with a massive, well-financed automobile manufacturer.



[Pixabay](#) – CC0 public domain.

Table 3.14 Buyers

A number of characteristics that impact the power of buyers to a given industry are illustrated below.

<p>A buyer group is powerful when there are relatively few buyers compared to the number of firms supplying the industry.</p>	<p>Buyers that purchase a large percentage of the seller's goods and services are more powerful, as Walmart has demonstrated by aggressively negotiating with suppliers over the years.</p>
<p>A buyer group is powerful when the industry's goods or services are standardized or undifferentiated.</p>	<p>Subway can drive a hard bargain when purchasing commodities such as wheat and yeast is typically identical to another vendor's.</p>
<p>A buyer group is powerful when they face little or no switching costs in changing vendors.</p>	<p>Circuses can find elephants, clowns, and trapeze artists from any source possible. This allows circus managers to shop around for the best prices.</p>
<p>A buyer group is powerful when the good or service purchased by the buyers represents a high percentage of the buyer's costs, encouraging ongoing searches for lower-priced suppliers.</p>	<p>Most consumers pay little attention to prices when buying toothpaste, but may spend hours exhaustively searching the Internet for information on automobile prices.</p>
<p>A buyer group is powerful if it can credibly threaten to compete (integrate backward) in the industry if motivated.</p>	<p>Ford and General Motors are well known for threatening to self-manufacture auto parts if suppliers do not provide goods and services at acceptable prices.</p>
<p>A buyer group is powerful when the good or service purchased by buyer groups is of limited importance to the quality or price of the buyer's offerings.</p>	<p>While stereo systems and tires are components that car buyers may be sensitive to when making a purchase decision, auto manufacturers can purchase glass and spark plugs from any vendor as long as it meets quality standards. This gives automakers leverage when negotiating with glass and spark plugs companies.</p>

The Power of an Industry's Buyers

Buyers purchase the goods and services that the firms in an industry produce (Table 3.14 "Buyers"). For Subway and other restaurants, buyers are individual people. In contrast, the buyers for some firms are other firms rather than end users. For Procter & Gamble, for example, buyers are retailers such as Walmart and Target who stock Procter & Gamble's pharmaceuticals, hair care products, pet supplies, cleaning products, and other household goods on their shelves.

The relative bargaining power between an industry's competitors and its buyers helps shape the profit potential of the industry. If buyers have greater leverage over the competitors than the competitors have over the buyers, then the competitors may be forced to lower their prices over time. This weakens competitors' profit margins and makes them less likely to be prosperous. Walmart furnishes a good example. The mammoth retailer is notorious among manufacturers of goods for demanding lower and lower prices over time (Bianco & Zellner, 2003). In 2008, for example, the firm threatened to stop selling compact discs if record companies did not lower their prices. Walmart has the power

to insist on price concessions because its sales volume is huge. Compact discs make up a small portion of Walmart's overall sales, so exiting the market would not hurt Walmart. From the perspective of record companies, however, Walmart is their biggest buyer. If the record companies were to refuse to do business with Walmart, they would miss out on access to a large portion of consumers.

On the other hand, if buyers have less leverage over the competitors than the competitors have over the buyers, then competitors can raise their prices and enjoy greater profits. This description fits the textbook industry quite well. College students are often dismayed to learn that an assigned textbook costs \$150 or more. Historically, textbook publishers have been able to charge high prices because buyers had no leverage. A student enrolled in a class must purchase the specific book that the professor has selected. Used copies are sometimes a lower-cost option, but textbook publishers have cleverly worked to undermine the used textbook market by releasing new editions after very short periods of time.

Of course, the presence of a very high profit industry is attractive to potential new entrants. Firms such as, the publisher of this book, have entered the textbook market with lower-priced offerings. Time will tell whether such offerings bring down textbook prices. Like any new entrant, upstarts in the textbook business must prove that they can execute their strategies before they can gain widespread acceptance. Overall, when analyzing the profit potential of their industry, executives must carefully consider whether buyers have the ability to demand lower prices. In the textbook market, buyers do not.



College students' lack of buyer power in the textbook industry has kept prices high for decades and created frustration for students.

anna gutermuth – 5/365 – CC BY 2.0.

Every industry is unique to some degree, but some general characteristics help to predict the likelihood that buyers will be powerful relative to the firms from which they purchase goods and services. Buyers tend to be powerful, for example, to the extent that there are relatively few buyers compared with the number of firms that supply the industry, the industry's goods or services are standardized or undifferentiated, buyers face little or no switching costs in changing

vendors, the good or service purchased by the buyers represents a high percentage of the buyer's costs, and the good or service is of limited importance to the quality or price of the buyer's offerings.

Finally, buyers possess power to the extent that they have the ability to become a new entrant to the industry if they wish. This strategy is called **backward vertical integration**. DIRECTV used to be an important customer of TiVo, the pioneer of digital video recorders. This situation changed, however, when executives at DIRECTV grew weary of their relationship with TiVo. DIRECTV then used a backward vertical integration strategy and started offering DIRECTV-branded digital video recorders. Profits that used to be enjoyed by TiVo were transferred at that point to DIRECTV.

The Limitations of Five Forces Analysis

Five forces analysis is useful, but it has some limitations too. The description of five forces analysis provided by its creator, Michael Porter, seems to assume that competition is a zero-sum game, meaning that the amount of profit potential in an industry is fixed. One implication is that, if a firm is to make more profit, it must take that profit from a rival, a supplier, or a buyer. In some settings, however, collaboration can create a larger pool of profit that benefits everyone involved in the collaboration. In general, collaboration is a possibility that five forces analysis tends to downplay. The relationships among the rivals in an industry, for example, are depicted as adversarial. In reality, these relationships are sometimes adversarial and sometimes collaborative. General Motors and Toyota compete fiercely all around the world, for example, but they also have worked together in joint ventures. Similarly, five forces analysis tends to portray a firm's relationships with its suppliers and buyers as adversarial, but many firms find ways to collaborate with these parties for mutual benefit. Indeed, concepts such as just-in-time inventory systems depend heavily on a firm working as a partner with its suppliers and buyers.

Key Takeaway

- “How much profit potential exists in our industry?” is a key question for executives. Five forces analysis provides an answer to this question. It does this by considering the interactions among the competitors in an industry, potential new entrants to the industry, substitutes for the industry's offerings, suppliers to the industry, and the industry's buyers.

Exercises

1. What are the five forces?
2. Is there an aspect of industry activity that the five forces seems to leave out?
3. Imagine you are the president of your college or university. Which of the five forces would be most important to you? Why?

References

Bianco, B., & Zellner, W. 2003, October 6. Is Wal-Mart too powerful? *Bloomberg Businessweek*. Retrieved from http://www.businessweek.com/magazine/content/03_40/b3852001_mz001.htm.

Odell, K. 2011, February 22. Portuguese-influenced Australian chicken burger chain, Oporto, comes to SoCal.

Eater LA. Retrieved from http://la.eater.com/archives/2011/02/22/portugueseinfluenced_australian_chicken_burger_chain_oporto_comes_to_social.php.

Porter, M. E. 1979, March–April. How competitive forces shape strategy. *Harvard Business Review*, 137–156.

3.5 Mapping Strategic Groups

Learning Objectives

1. Understand what strategic groups are.
2. Learn three ways that analyzing strategic groups is useful to organizations.

Table 3.15 Strategic Groups

Strategic groups are sets of firms that follow similar strategies. Understanding the nature of strategic groups within an industry is important in part because the members of a firm's group are usually that firm's closest rivals. Below we illustrate several strategic groups in the restaurant industry.

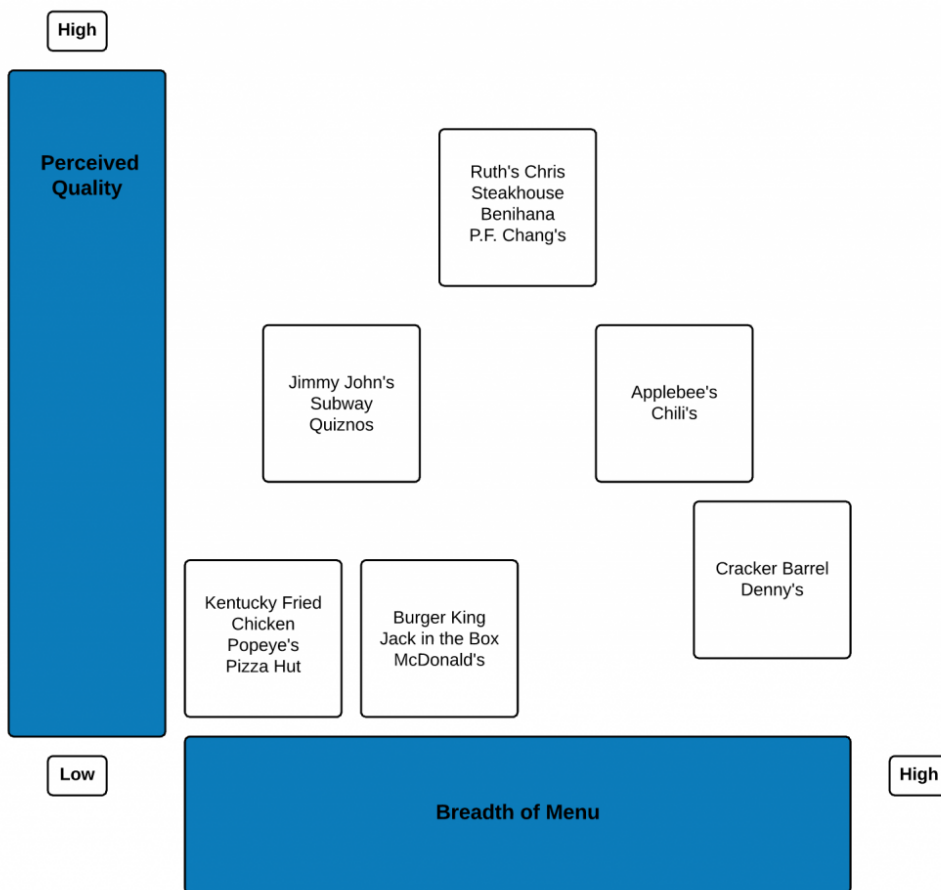

The analysis of the [strategic groups](#) in an industry can offer important insights to executives. Strategic groups are sets of firms that follow similar strategies to one another (Hunt, 1972; Short, et. al., 2007). More specifically, a strategic

group consists of a set of industry competitors that have similar characteristics to one another but differ in important ways from the members of other groups (Table 3.15 “Strategic Groups”).

Understanding the nature of strategic groups within an industry is important for at least three reasons. First, emphasizing the members of a firm’s group is helpful because these firms are usually its closest rivals. When assessing their firm’s performance and considering strategic moves, the other members of a group are often the best referents for executives to consider. In some cases, one or more strategic groups in the industry are irrelevant. Subway, for example, does not need to worry about competing for customers with the likes of Ruth’s Chris Steak House and P. F. Chang’s. This is partly because firms confront [mobility barriers](#) that make it difficult or illogical for a particular firm to change groups over time. Because Subway is unlikely to offer a gourmet steak as well as the experience offered by fine-dining outlets, they can largely ignore the actions taken by firms in that restaurant industry strategic group.

Second, the strategies pursued by firms within other strategic groups highlight alternative paths to success. A firm may be able to borrow an idea from another strategic group and use this idea to improve its situation. During the recession of the late 2000s, midquality restaurant chains such as Applebee’s and Chili’s used a variety of promotions such as coupons and meal combinations to try to attract budget-conscious consumers. Firms such as Subway and Quiznos that already offered low-priced meals still had an inherent price advantage over Applebee’s and Chili’s, however: There is no tipping expected at the former restaurants, but there is at the latter. It must have been tempting to executives at Applebee’s and Chili’s to try to expand their appeal to budget-conscious consumers by experimenting with operating formats that do not involve tipping.



Midquality restaurants do not compete directly with pricey steakhouses, but they might be able to borrow ideas from such venues.

Tella Chen – [Steak](#) – CC BY-NC 2.0.

Third, the analysis of strategic groups can reveal gaps in the industry that represent untapped opportunities. Within the restaurant business, for example, it appears that no national chain offers both very high-quality meals and a very diverse menu. Perhaps the firm that comes the closest to filling this niche is the Cheesecake Factory, a chain of approximately 150 outlets whose menu includes more than 200 lunch, dinner, and dessert items. Ruth’s Chris Steak House already offers very high quality food; its executives could consider moving the firm toward offering a very diverse menu as well. This would involve considerable risk, however. Perhaps no national chain offers both very high quality

meals and a very diverse menu because doing so is extremely difficult. Nevertheless, examining the strategic groups in an industry with an eye toward untapped opportunities offers executives a chance to consider novel ideas.

Key Takeaway

- Examination of the strategic groups in an industry provides a firm's executives with a better understanding of their closest rivals, reveals alternative paths to success, and highlights untapped opportunities.

Exercises

1. What other colleges and universities are probably in your school's strategic group?
2. From what other groups of colleges and universities could your school learn? What specific ideas could be borrowed from these groups?

References

Hunt, M. S. 1972. *Competition in the major home appliance industry 1960–1970*. (Unpublished doctoral dissertation). Harvard University, Cambridge, MA.

Short, J. C., Ketchen, D. J., Palmer, T., & Hult, G. T. 2007. Firm, strategic group, and industry influences on performance. *Strategic Management Journal*, 28, 147–167.

3.6 Conclusion

This chapter explains several considerations for examining the external environment that executives must monitor to lead their organizations strategically. Executives must be aware of trends and changes in the general environment, as well as the condition of their specific industry, as elements of both have the potential to change considerably over time. While PESTEL analysis provides a useful framework to understand the general environment, Porter's five forces is helpful to make sense of an industry's profit potential. Strategic groups are valuable for understanding close competitors that affect a firm more than other industry members. When executives carefully monitor their organization's environment using these tools, they greatly increase the chances of their organization being successful.

Exercises

1. In groups of four or five, use the PESTEL framework to identify elements from each factor of the general environment that could have a large effect on your future career.
2. Use Porter's five forces analysis to analyze an industry in which you might like to work in the future. Discuss the implications your results may have on the salary potential of jobs in that industry and how that could impact your career plans.

Chapter 4: Managing Firm Resources

Chapter 4: Managing Firm Resources

4.1 Managing Firm Resources

4.2 Resource-Based Theory

4.3 Intellectual Property

4.4 Value Chain

4.5 Beyond Resource-Based Theory: Other Views on Firm Performance

4.6 SWOT Analysis

4.7 Conclusion

4.1 Managing Firm Resources

Learning Objectives

After reading this chapter, you should be able to understand and articulate answers to the following questions:

1. What is resource-based theory, and why is it important to organizations?
2. In what ways can intellectual property serve as a value-added resource for organizations?
3. How should executives use the value chain to maximize the performance of their organizations?
4. What is SWOT analysis and how can it help an organization?

Southwest Airlines: Let Your LUV Flow



Southwest Airlines' acquisition of AirTran in 2011 may lead the firm into stormy skies.

[Wikimedia Commons](#) – CC BY 2.0.

In 1971, an upstart firm named Southwest Airlines opened for business by offering flights between Houston, San Antonio, and its headquarters at Love Field in Dallas. From its initial fleet of three airplanes and three destinations, Southwest has grown to operate hundreds of airplanes in scores of cities. Despite competing in an industry that is infamous for bankruptcies and massive financial losses, Southwest marked its thirty-eighth profitable year in a row in 2010.

Why has Southwest succeeded while many other airlines have failed? Historically, the firm has differed from its competitors in a variety of important ways. Most large airlines use a “hub and spoke” system. This type of system routes travelers through a large hub airport on their way from one city to another. Many Delta passengers, for example, end a flight in Atlanta and then take a connecting flight to their actual destination. The inability to travel directly between most pairs of cities adds hours to a traveler’s itinerary and increases the chances of luggage being lost. In contrast, Southwest does not have a hub airport; preferring instead to connect cities directly. This helps make flying on Southwest attractive to many travelers.

Southwest has also been more efficient than its rivals. While most airlines use a variety of different airplanes, Southwest operates only one type of jet: the Boeing 737. This means that Southwest can service its fleet much more efficiently than can other airlines. Southwest mechanics need only the know-how to fix one type of airplane, for example, while their counterparts with other firms need a working knowledge of multiple planes. Southwest also gains efficiency by not offering seat assignments in advance, unlike its competitors. This makes the boarding process move more quickly, meaning that Southwest’s jets spend more time in the air transporting customers (and making money) and less time at the gate relative to its rivals’ planes.

Organizational culture is the dimension along which Southwest perhaps has differed most from its rivals. The airline industry as a whole suffers from a reputation for mediocre (or worse) service and indifferent (sometimes even surly) employees. In contrast, Southwest enjoys strong loyalty and a sense of teamwork among its employees.

One tangible indicator of this culture is Southwest’s stock ticker symbol. Most companies choose stock ticker symbols that evoke their names. Ford’s ticker symbol is F, for example, and Walmart’s symbol is WMT. When Southwest became a publicly traded company in 1977, executives chose LUV as its ticker symbol. LUV pays a bit of homage to the firm’s humble beginnings at Love Field. More important, however, LUV represents the love that executives have created among employees, between employees and the company, and between customers and the company. This “LUV affair” has long been and remains a huge success. As recently as March 2011, for example, Southwest was ranked fourth on *Fortune* magazine’s World’s Most Admired Company list.

In September 2010, Southwest surprised many observers when it announced that it was acquiring AirTran Airways for \$1.4 billion. Southwest and AirTran both emphasized low fares, but they differed in many ways. AirTran routed most of its passengers through a hub-and-spoke system, and it relied on a different plane than Southwest, the Boeing 717. The acquisition of AirTran thus raised important questions about Southwest’s future (Schlangenhein & Hughes, 2010). How would AirTran’s hub-and-spoke system be integrated with Southwest’s nonhub approach? Could the airlines’ respective fleets of 737s and 717s be joined without losing efficiency? Perhaps most important, could Southwest maintain its legendary organizational culture while taking over a sizable rival and integrating AirTran’s thousands of employees? When the acquisition was finalized on May 2, 2011, it remained unclear whether Southwest was flying off course or whether Southwest’s “LUV story” would continue for many years.

References

Schlangenstein, M., & Hughes, J. 2010, September 28. Southwest risks keep-it-simple focus to spur growth. Retrieved from <http://www.washingtonpost.com/wp-dyn/content/article/2010/09/28/AR2010092801578.html>.

4.2 Resource-Based Theory

Learning Objectives

1. Define the four characteristics of resources that lead to sustained competitive advantage as articulated by the resource-based theory of the firm.
2. Understand the difference between resources and capabilities.
3. Be able to explain the difference between tangible and intangible resources.
4. Know the elements of the marketing mix.

Table 4.1 Resource-Based Theory: The Basics

According to resource-based theory, organizations that own “strategic resources” have important competitive advantages over organizations that do not. Some resources, such as cash and trucks, are not considered to be strategic resources because an organization’s competitors can readily acquire them. Instead, a resource is strategic to the extent that it is valuable, rare, difficult to imitate, and nonsubstitutable.

Strategic Resources	Expansion
VALUABLE resources aid in improving the organization's effectiveness and efficiency while neutralizing the opportunities and threats of competitors.	Although the airline industry is extremely competitive, Southwest Airlines' turns a profit virtually every year. One key reason why is a legendary organizational culture that inspires employees to do their very best.
RARE resources are those held by few or no other competitors.	Southwest Airlines' culture provides the firm with uniquely strong employee relations in an industry where strikes, layoffs, and poor morale are common.
DIFFICULT-TO-IMITATE resources often involve legally protected intellectual property such as trademarks, patents, or copyrights. Other difficult-to-imitate resources, such as brand names, usually need time to develop fully.	Southwest's culture arose from its very humble beginnings and has evolved across four decades. Because of this unusual history, other airlines could not replicate Southwest's culture, regardless of how hard they might try.
NONSUBSTITUTABLE resources exist when the resource combinations of other firms cannot duplicate the strategy provided by the resource bundle of a particular firm.	The influence of Southwest's organizational culture extends to how customers are treated by employees. Executives at other airlines would love to attract the customer loyalty that Southwest enjoys, but they have yet to find ways to inspire the kind of customer service that the Southwest culture encourages.

Important Points to Remember:

1. Resources such as Southwest's culture that reflect all four qualities—valuable, rare, difficult to imitate, and nonsubstitutable—are ideal because they can create sustained competitive advantages. A resource that has three or less of the qualities can provide an edge in the short term, but competitors can overcome such an advantage eventually.
2. Firms often bundle together multiple resources and strategies (that may not be unique in and of themselves) to create uniquely powerful combinations. Southwest's culture is complemented by approaches that individually could be copied—the airline's emphasis on direct flights, its reliance on one type of plane, and its unique system for passenger boarding—in order to create a unique business model in which effectiveness and efficiency is the envy of competitors.
3. Satisfying only one or two of the valuable, rare, difficult to imitate, nonsubstitutable criteria will likely only lead to competitive parity or a temporary advantage.

Four Characteristics of Strategic Resources

Southwest Airlines provides an illustration of resource-based theory in action. [Resource-based theory](#) contends that the possession of strategic resources provides an organization with a golden opportunity to develop competitive advantages

over its rivals (Table 4.1 “Resource-Based Theory: The Basics”). These competitive advantages in turn can help the organization enjoy strong profits (Barney, 1991; Wernerfelt, 1981).

A strategic resource is an asset that is valuable, rare, difficult to imitate, and nonsubstitutable (Barney, 1991; Chi, 1994). A resource is **valuable** to the extent that it helps a firm create strategies that capitalize on opportunities and ward off threats. Southwest Airlines’ culture fits this standard well. Most airlines struggle to be profitable, but Southwest makes money virtually every year. One key reason is a legendary organizational culture that inspires employees to do their very best. This culture is also **rare** in that strikes, layoffs, and poor morale are common within the airline industry.

Competitors have a hard time duplicating resources that are **difficult to imitate**. Some difficult to imitate resources are protected by various legal means, including trademarks, patents, and copyrights. Other resources are hard to copy because they evolve over time and they reflect unique aspects of the firm. Southwest’s culture arose from its very humble beginnings. The airline had so little money that at times it had to temporarily “borrow” luggage carts from other airlines and put magnets with the Southwest logo on top of the rivals’ logo. Southwest is a “rags to riches” story that has evolved across several decades. Other airlines could not replicate Southwest’s culture, regardless of how hard they might try, because of Southwest’s unusual history.

A resource is **nonsubstitutable** when competitors cannot find alternative ways to gain the benefits that a resource provides. A key benefit of Southwest’s culture is that it leads employees to treat customers well, which in turn creates loyalty to Southwest among passengers. Executives at other airlines would love to attract the customer loyalty that Southwest enjoys, but they have yet to find ways to inspire the kind of customer service that the Southwest culture encourages.



Southwest Airlines’ unique culture is reflected in the customization of their aircraft over the years, such as the “Lone Star One” design.

[Wikimedia Commons](#) – CC BY 2.0.

Ideally, a firm will have a culture, like Southwest firm will own resources like Southwest’s culture that embraces the four qualities shown in Table 4.1 “Resource-Based Theory: The Basics”. that have all four of these qualities. If so, these resources can provide not only a competitive advantage but also a **sustained competitive advantage**—one

that will endure over time and help the firm stay successful far into the future. Resources that do not have all four qualities can still be very useful, but they are unlikely to provide long-term advantages. A resource that is valuable and rare but that can be imitated, for example, might provide an edge in the short term, but competitors can overcome such an advantage eventually.

Resource-based theory also stresses the merit of an old saying: the whole is greater than the sum of its parts. Specifically, it is also important to recognize that strategic resources can be created by taking several strategies and resources that each could be copied and bundling them together in a way that cannot be copied. For example, Southwest's culture is complemented by approaches that individually could be copied—the airline's emphasis on direct flights, its reliance on one type of plane, and its unique system for passenger boarding—to create a unique business model whose performance is without peer in the industry.

Resource-based theory can be confusing because the term *resources* is used in many different ways within everyday common language. It is important to distinguish strategic resources from other resources. To most individuals, cash is an important resource. Tangible goods such as one's car and home are also vital resources. When analyzing organizations, however, common resources such as cash and vehicles are not considered to be strategic resources. Resources such as cash and vehicles are valuable, of course, but an organization's competitors can readily acquire them. Thus an organization cannot hope to create an enduring competitive advantage around common resources.

On occasion, events in the environment can turn a common resource into a strategic resource. Consider, for example, a very generic commodity: water. Humans simply cannot live without water, so water has inherent value. Also, water cannot be imitated (at least not on a large scale), and no other substance can substitute for the life-sustaining properties of water. Despite having three of the four properties of strategic resources, water in the United States has remained cheap. Yet this may be changing. Major cities in hot climates such as Las Vegas, Los Angeles, and Atlanta are confronted by dramatically shrinking water supplies. As water becomes more and more rare, landowners in Maine stand to benefit. Maine has been described as "the Saudi Arabia of water" because its borders contain so much drinkable water. It is not hard to imagine a day when companies in Maine make huge profits by sending giant trucks filled with water south and west or even by building water pipelines to service arid regions.

Table 4.2 Resources and Capabilities

Resources and capabilities are the basic building blocks that organizations use to create strategies. These two building blocks are tightly linked—capabilities from using resources over time.

Tangible resources are resources that can be readily seen, touched, and quantified. Physical assets such as a firm's property, plant, and equipment are considered to be tangible resources, as is cash.

Intangible resources are quite difficult to see, touch, or quantify. Intangible resources include, for example, the knowledge and skills of employees, a firm's reputation, and a firm's culture. In a nod to Southwest Airlines' outstanding reputation, the firm ranks fourth in *Fortune* magazine's 2011 list of the "World's Most Admired Companies." Only Apple, Google, and Berkshire Hathaway enjoy a stronger reputation.

A *dynamic capability* exists when a firm is skilled at continually updating its array of capabilities to keep pace with changes in its environment. General Electric, for example, buys and sells firms to maintain its market leadership over time while Coca-Cola has an uncanny knack for building new brands and products as the soft-drink market evolves. Not surprisingly, both of these firms rank among the top thirteen among the "World's Most Admired Companies" for 2011.

From Resources to Capabilities

The tangibility of a firm's resources is an important consideration within resource-based theory. **Tangible resources** are resources that can be readily seen, touched, and quantified. Physical assets such as a firm's property, plant, and equipment, as well as cash, are considered to be tangible resources. In contrast, **intangible resources** are quite difficult to see, to touch, or to quantify. Intangible resources include, for example, the knowledge and skills of employees, a firm's reputation, and a firm's culture. In comparing the two types of resources, intangible resources are more likely to meet the criteria for strategic resources (i.e., valuable, rare, difficult to imitate, and nonsubstitutable) than are tangible resources. Executives who wish to achieve long-term competitive advantages should therefore place a premium on trying to nurture and develop their firms' intangible resources.

Capabilities are another key concept within resource-based theory. A good and easy-to-remember way to distinguish resources and capabilities is this: resources refer to what an organization *owns*, capabilities refer to what the organization can *do* (Table 4.2 "Resources and Capabilities"). Capabilities tend to arise over time as a firm takes actions that build on its strategic resources. Southwest Airlines, for example, has developed the capability of providing excellent customer service by building on its strong organizational culture. Capabilities are important in part because they are how organizations capture the potential value that resources offer. Customers do not simply send money to an organization because it owns strategic resources. Instead, capabilities are needed to bundle, to manage, and otherwise to exploit resources in a manner that provides value added to customers and creates advantages over competitors.

Some firms develop a **dynamic capability**. This means that a firm has a unique capability of creating new capabilities. Said differently, a firm that enjoys a dynamic capability is skilled at continually updating its array of capabilities to keep pace with changes in its environment. General Electric, for example, buys and sells firms to maintain its market leadership over time, while Coca-Cola has an uncanny knack for building new brands and products as the soft-drink market evolves. Not surprisingly, both of these firms rank among the top thirteen among the "World's Most Admired Companies" for 2011.

Strategy at the Movies

That Thing You Do!

How can the members of an organization reach success "doing that thing they do"? According to resource-based theory, one possible road to riches is creating—on purpose or by accident—a unique combination of resources. In the 1996 movie *That Thing You Do!*, unwittingly assembling a unique bundle of resources leads a 1960s band called The Wonders to rise from small-town obscurity to the top of the music charts. One resource is lead singer Jimmy Mattingly, who possesses immense musical talent. Another is guitarist Lenny Haise, whose fun attitude reigns in the enigmatic Mattingly. Although not a formal band member, Mattingly's girlfriend Faye provides emotional support to the group and even suggests the group's name. When the band's usual drummer has to miss a gig due to injury, the door is opened for charismatic drummer Guy Patterson, whose energy proves to be the final piece of the puzzle for The Wonders.

Despite Mattingly's objections, Guy spontaneously adds an up-tempo beat to a sleepy ballad called "That Thing You Do!" during a local talent contest. When the talent show audience goes crazy in response, it marks the beginning of a meteoric rise for both the song and the band. Before long, The Wonders perform on television and "That Thing You Do!" is a top-ten hit record. The band's magic vanishes as quickly as it appeared, however. After their bass player joins the Marines, Lenny elopes on a whim, and Jimmy's diva attitude runs amok, the band is finished and Guy is left to "wonder" what might have been. *That Thing You Do!* illustrates that while bundling resources in a unique way can create immense success, preserving and managing these resources over time can be very difficult.



Liv Tyler plays Faye Dolan, the love interest of drummer Guy Patterson, in *That Thing You Do!*

[Wikimedia Commons](#) – CC BY 3.0.

Is Resource-Based Theory Old News?

Resource-based theory has evolved in recent years to provide a way to understand how strategic resources and

capabilities allow firms to enjoy excellent performance. But more than one wry observer has wondered aloud, “Is resource-based theory just old wine in a new bottle?” This is a question worth considering because the role of resources in shaping success and failure has been discussed for many centuries.

Aesop was a Greek storyteller who lived approximately 2,500 years ago. Aesop is known in particular for having created a series of fables—stories that appear on the surface to be simply children’s tales but that offer deep lessons for everyone. One of Aesop’s fables focuses on an ass (donkey) and some grasshoppers. When the ass tries to duplicate the sweet singing of the grasshoppers by copying their diet, he soon dies of starvation. Attempting to replicate the grasshoppers’ unique singing capability proved to be a fatal mistake (Figure 4.3 “Aesop’s Fables”). The fable illustrates a central point of resource-based theory: it is an array of resources and capabilities that fuels enduring success, not any one resource alone.

In a far more recent example, sociologist Philip Selznick developed the concept of [distinctive competence](#) through a series of books in the 1940s and 1950s (Selznick, 1957; Selznick, 1949). A distinctive competence is a set of activities that an organization performs especially well. Southwest Airlines, for example, appears to have a distinctive competency in operations, as evidenced by how quickly it moves its flights in and out of airports. Further, Selznick suggested that possessing a distinctive competency creates a competitive advantage for a firm. Certainly, there is plenty of overlap between the concept of distinctive competency, on the one hand, and capabilities, on the other.

Figure 4.3 Aesop’s Fables

Many of the classic fables of the ancient Greek storyteller Aesop hold powerful lessons for strategic management in general and the management of resources in particular. We illustrate the fable of "The Ass and the Grasshoppers" below.

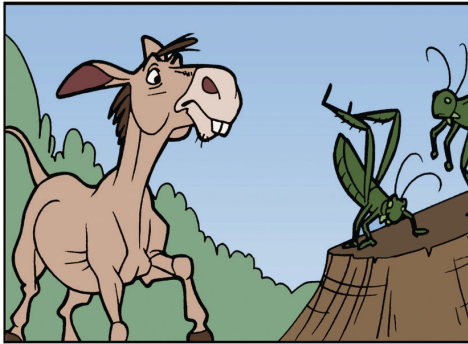

As the story goes, an ass was enchanted by the chirping of some melodic grasshoppers and wished to acquire that ability.

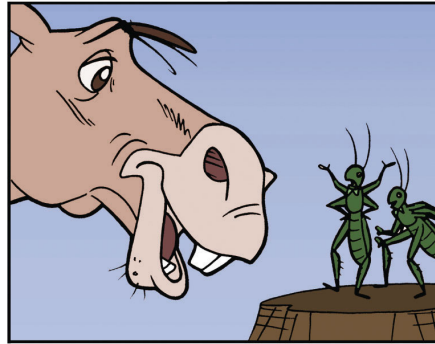

When the ass asked the grasshoppers what enabled them to sing so sweetly, they revealed that only the morning dew nourished them.



In an effort to copy the grasshoppers, the ass began to follow their diet.



Consequently, the ass soon died of hunger.

Key Takeaway

This fable illustrates the notion of *resource mobility*. Classic economics suggests that any resource that leads to short-term advantage can be imitated when other firms purchase the resource on the open market. If this logic was true, the ass should have been able to duplicate the grasshoppers' sweet songs by eating the same diet as the grasshoppers.

But resource-based theory emphasizes the importance of a firm's set or bundle of resources. The purchase of any single resource, such as the morning dew, is unlikely to lead to superior performance for others, such as the ass. As in the fable, copying someone else's strategy actually may lead to very bad outcomes.

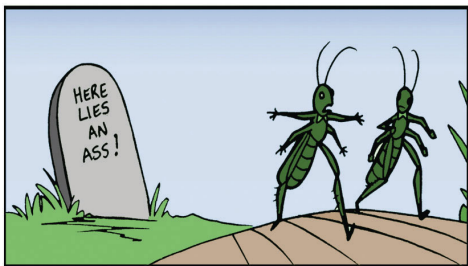

Adapted from Chapter 4 of Atlas Black: Managing to Succeed and Short, J. & Ketchen, D. 2005. Using classic literature to teach timeless truths: An illustration using Aesop's fables to teach strategic management. *Journal of Management Education*, 29, 6, 816–832.

So is resource-based theory in fact old wine in a new bottle? Not really. Resource-based theory builds on past ideas about resources, but it represents a big improvement on past ideas in at least two ways. First, resource-based theory offers a complete framework for analyzing organizations, not just snippets of valuable wisdom like Aesop and

Selznick provided. Second, the ideas offered by resource-based theory have been developed and refined through scores of research studies involving thousands of organizations. In other words, there is solid evidence backing it up.

The Marketing Mix

Table 4.4 The Marketing Mix

Much like a baker mixes together ingredients to create a delicious cake, executives need to blend together various ways to appeal to customers. As one of the most famous business “recipes,” the marketing mix suggests four factors that need to work together in order for a firm to achieve superior performance. The four Ps of the marketing mix are illustrated below using Duff Goldman’s custom cake shop, Charm City Cakes.

A firm’s product is what it sells to customers. The unique cakes offered by Duff have included replicas of Radio City Music Hall and the Hubble space telescope.
The price of a good or service should provide a good match with the value offered. While a grocery store’s cake might sell for \$30 or less, the uniqueness of Duff’s cakes allows him to charge upwards of \$1,000 per cake.
Place can refer to a physical purchase point as well as a distribution channel. The location of Charm City Cakes is itself unique—a converted church. This adds to the hip image Duff tries to project.
Promotion consists of the communications used to market a product, including advertising, public relations, and other forms of direct and indirect selling. Duff’s popular show on The Food Network, <i>Ace of Cakes</i> , spread Duff’s fame and extended the reach of his cake shop dramatically.

Leveraging resources and capabilities to create desirable products and services is important, but customers must still be convinced to purchase these goods and services. The **marketing mix**—also known as the four Ps of marketing—provides important insights into how to make this happen. A master of the marketing mix was circus impresario P. T. Barnum, who is famous in part for his claim that “there’s a sucker born every minute.” The real purpose of the marketing mix is not to trick customers but rather to provide a strong alignment among the four Ps (product, price, place, and promotion) to offer customers a coherent and persuasive message (Table 4.4 “The Marketing Mix”).

A firm’s **product** is what it sells to customers. Southwest Airlines sells, of course, airplane flights. The airline tries to set its flights apart from those of airlines by making flying fun. This can include, for example, flight attendants offering preflight instructions as a rap. The **price** of a good or service should provide a good match with the value offered. Throughout its history, Southwest has usually charged lower airfares than its rivals. **Place** can refer to a physical purchase point as well as a distribution channel. Southwest has generally operated in cities that are not served by many airlines and in secondary airports in major cities. This has allowed the firm to get favorable lease rates at airports and has helped it create customer loyalty among passengers who are thankful to have access to good air travel.

Finally, **promotion** consists of the communications used to market a product, including advertising, public relations, and other forms of direct and indirect selling. Southwest is known for its clever advertising. In a recent television advertising campaign, for example, Southwest lampooned the baggage fees charged by most other airlines while highlighting its more customer-friendly approach to checked luggage. Given the consistent theme of providing a good value plus an element of fun to passengers that is developed across the elements of the marketing mix, it is no surprise that Southwest has been so successful within a very challenging industry.



Few executives in history have had the marketing savvy of P. T. Barnum.

[Wikimedia Commons](#) – public domain.

Key Takeaway

- Resource-based theory suggests that resources that are valuable, rare, difficult to imitate, and nonsubstitutable best position a firm for long-term success. These strategic resources can provide the foundation to develop firm capabilities that can lead to superior performance over time. Capabilities are needed to bundle, to manage, and otherwise to exploit resources in a manner that provides value added to customers and creates advantages over competitors.

Exercises

1. Does your favorite restaurant have the four qualities of resources that lead to success as articulated by resource-based theory?
2. If you were hired by your college or university to market your athletic department, what element of the marketing mix would you focus on first and why?
3. What other classic stories or fables could be applied to discuss the importance of firm resources and superior performance?

References

- Barney, J. B. 1991. Firm resources and sustained competitive advantage. *Journal of Management*, 17, 99–120.
- Chi, T. 1994. Trading in strategic resources: Necessary conditions, transaction cost problems, and choice of exchange structure. *Strategic Management Journal*, 15(4), 271–290.
- Selznick, P. 1957. *Leadership in administration*. New York: Harper; Selznick, P. 1952. *The organizational weapon*. New York, NY: McGraw-Hill.
- Selznick, P. 1952. *The organizational weapon*. New York, NY: McGraw-Hill; Selznick, P. 1949. *TVA and the grass roots*. Berkeley, CA: University of California Press.
- Wernerfelt, B. 1984. A resource-based view of the firm. *Strategic Management Journal*, 5, 171–180.

4.3 Intellectual Property

Learning Objectives

1. Define the four major types of intellectual property.
2. Be able to provide examples of each intellectual property type.
3. Understand how intellectual property can be a valuable resource for firms.

Defining Intellectual Property

The inability of competitors to imitate a strategic resource is a key to leveraging the resource to achieve long-term competitive advantages. Companies are clever, and effective imitation is often very possible. But resources that involve intellectual property reduce or even eliminate this risk. As a result, developing intellectual property is important to many organizations.

Intellectual property refers to creations of the mind, such as inventions, artistic products, and symbols. The four main types of intellectual property are patents, trademarks, copyrights, and trade secrets (Table 4.5 “Types of Intellectual Property”). If a piece of intellectual property is also valuable, rare, and nonsubstitutable, it constitutes a strategic resource. Even if a piece of intellectual property does not meet all four criteria for serving as a strategic resource, it can be bundled with other resources and activities to create a resource.

A variety of formal and informal methods are available to protect a firm’s intellectual property from imitation by rivals. Some forms of intellectual property are best protected by legal means, while defending others depends on surrounding them in secrecy. This can be contrasted with Southwest Airlines’ well-known culture, which rivals are free to attempt to copy if they wish. Southwest’s culture thus is not intellectual property, although some of its complements such as Southwest’s logo and unique color schemes are.

Table 4.5 Types of Intellectual Property

*The term **intellectual property** refers to creations of the mind, such as inventions, artistic products, and symbols. Some forms of intellectual property by law while others can best be defended by surrounding them in secrecy.*

Patents protect inventions from direct imitation for a limited period of time. Within the pharmaceutical industry, patents protect the new drugs created by firms such as Merck and Pfizer for up to twenty years. If a new drug gains acceptance in the market, its patent creates a window of opportunity for the patent holder to enjoy excellent profits.

Trademarks are phrases, pictures, names, or symbols used to identify a particular organization. McDonald's golden arches, the phrase "Intel Inside," and the brand name Old Navy are examples of trademarks.

Copyrights provide exclusive rights to the creators of original artistic works such as books, movies, songs, and screenplays. Sometimes copyrights are sold and licensed. The late pop star Michael Jackson bought the rights to The Beatle's music catalog and later licensed songs to Target and other companies for use in television advertisements.

Trade secrets refer to formulas, practices, and designs that are central to a firm's business and that remain unknown to competitors. One famous example is the blend of eleven herbs and spices used in Kentucky Fried Chicken's original recipe chicken. KFC protects this secret by having multiple suppliers each produce a portion of the herb and spice blend; no one supplier knows the full recipe.

Patents

Table 4.6 Patents

Patents protect inventions from direct imitation for a limited period of time. Some examples and key issues surrounding patents are illustrated below.

<p>To earn a patent from the U.S. Patent and Trademark Office, an inventor must demonstrate that an invention is new, non-obvious, and useful.</p>	<p>As several different inventors raced to create a workable system for voice transmission over wires, Alexander Graham Bell was awarded a patent for the telephone in 1876.</p>
<p>Perhaps the greatest inventor in history was Thomas Edison, who was awarded over one thousand patents.</p>	<p>In a 2011 lawsuit, EBSCO alleged that Bass Pro Shops sold a product that violated EBSCO's patent on a deer-hunting stand that helps prevent hunters from falling out of trees. EBSCO's complaint was settled out of court.</p>

Patents are legal decrees that protect inventions from direct imitation for a limited period of time (Table 4.6 "Patents"). Obtaining a patent involves navigating a challenging process. To earn a patent from the US Patent and Trademark Office, an inventor must demonstrate that an invention is new, nonobvious, and useful. If the owner of a patent believes that a company or person has infringed on the patent, the owner can sue for damages. In 2011, for example, a private company named EBSCO alleged that retailer Bass Pro Shops sold a product that violated EBSCO's patent on a deer-hunting stand that helps prevent hunters from falling out of trees. Rather than endure a costly legal fight, the two sides agreed to settle EBSCO's complaint out of court.

Patenting an invention is important because patents can fuel enormous profits. Imagine, for example, the potential for lost profits if the Slinky had not been patented. Shipyard engineer Richard James came up with the idea for the Slinky by accident in 1943 while he was trying to create springs for use in ship instruments. When James accidentally tipped

over one of his springs, he noticed that it moved downhill in a captivating way. James spent his free time perfecting the Slinky and then applied for a patent in 1946. To date, more than three hundred million Slinkys have been sold by the company that Richard James and his wife Betty created.



Patenting inventions such as the Slinky helps ensure that the invention is protected from imitation.

[Wikimedia Commons](#) – public domain.

Trademarks

Trademarks are phrases, pictures, names, or symbols used to identify a particular organization ([Table 4.7 “Trademarks”](#)). Trademarks are important because they help an organization stand out and build an identity in the marketplace. Some trademarks are so iconic that almost all consumers recognize them, including McDonald’s golden arches, the Nike swoosh, and Apple’s outline of an apple.

Other trademarks help rising companies carve out a unique niche for themselves. For example, French shoe designer Christian Louboutin has trademarked the signature red sole of his designer shoes. Because these shoes sell for many hundreds of dollars via upscale retailers such as Neiman Marcus and Saks Fifth Avenue, competitors would love to copy their look. Thus legally protecting the distinctive red sole from imitation helps preserve Louboutin’s profits.



Fashionistas instantly recognize the trademark red sole of Christian Louboutin's high-end shoes.

[Wikimedia Foundation](#) – CC BY-SA 3.0.

Trademarks are important to colleges and universities. Schools earn tremendous sums of money through royalties on T-shirts, sweatshirts, hats, backpacks, and other consumer goods sporting their names and logos. On any given day, there are probably several students in your class wearing one or more pieces of clothing featuring your school's insignia; your school benefits every time items like this are sold.

Schools' trademarks are easy to counterfeit, however, and the sales of counterfeit goods take money away from colleges and universities. Not surprisingly, many schools fight to protect their trademarks. In October 2009, for example, the University of Oklahoma announced that it was teaming with law enforcement officials to combat the sale of counterfeit goods around its campus (Ward, 2009). This initiative and similar ones at other colleges and universities are designed to ensure that schools receive their fair share of the sales that their names and logos generate.

Table 4.7 Trademarks

An organization's trademarks consist of phrases, pictures, names, or symbols that are closely associated with the organization. Some examples and key issues surrounding trademarks are illustrated below.

<p>To be fully protected in the United States, a trademark must be registered with the United States Patent and Trademark Office. A capital R with a circle around it denotes a registered trademark.</p>	<p>Many small companies use their founders' name as the basis for a trademarked company name.</p>
<p>As part of the punishment for German aggression during World War I, German drug maker Bayer lost its trademark on "Aspirin" in France, Russia, the United Kingdom, and the United States. Today, Bayer still retains its trademark in Germany, Canada, Mexico and dozens of other countries.</p>	<p>The distinctive pattern of Burberry Ltd. is an example of a trademark that does not involve words or symbols.</p>

Copyrights

The rights of creators of original artistic works such as books, movies, songs, and screenplays are protected by copyrights. Some examples and key issues surrounding copyrights are illustrated below.

<p>In China, millions of pirated DVDs are sold each year, and music piracy is estimated to account for at least 95 percent of music sales. In response, the U.S. government has pressed its Chinese counterpart to better enforce copyrights.</p>	<p>The presence of the copyright symbol tells consumers that they are not allowed to duplicate the product that carries the copyright.</p>	<p>When it became apparent that The Verve's 1997 hit single "Bittersweet Symphony" duplicated a Rolling Stones song, The Verve was forced to give up the copyright for the song.</p>
<p>Today's cheesy television ads aimed at inventors follow a long tradition of companies offering to help individuals copyright their ideas—for a small fee, of course.</p>	<p>A painting such as Johannes Vermeer's "Girl with a Pearl Earring" enters the public domain (i.e., is not subject to copyright) one hundred years after its creator's death.</p>	

Copyrights provide exclusive rights to the creators of original artistic works such as books, movies, songs, and screenplays (Figure 4.8 "Copyrights"). Sometimes copyrights are sold and licensed. In the late 1960s, Buick thought it had an agreement in place to license the number one hit "Light My Fire" for a television advertisement from The Doors until the band's volatile lead singer Jim Morrison loudly protested what he saw as mistreating a work of art. Classic rock by The Beatles has been used in television ads in recent years. After the late pop star Michael Jackson bought the rights to the band's music catalog, he licensed songs to Target and other companies. Some devoted music fans consider such ads to be abominations, perhaps proving the merit of Morrison's protest decades ago.



He looks calm here, but the licensing of a copyrighted song for a car commercial enraged rock legend Jim Morrison.

[Wikimedia Commons](#) – public domain.

Over time, [piracy](#) has become a huge issue for the owners of copyrighted works. In China, millions of pirated DVDs are sold each year, and music piracy is estimated to account for at least 95 percent of music sales. This piracy deprives movie studios, record labels, and artists of millions of dollars in royalties. In response to the damage piracy has caused, the US government has pressed its Chinese counterpart and other national governments to better enforce copyrights.

Trade Secrets

[Trade secrets](#) refer to formulas, practices, and designs that are central to a firm's business and that remain unknown to competitors ([Table 4.9 "Trade Secrets"](#)). Trade secrets are protected by laws on theft, but once a secret is revealed, it cannot be a secret any longer. This leads firms to rely mainly on silence and privacy rather than the legal system to protect trade secrets.

Table 4.9 Trade Secrets

Trade secrets are formulas, practices, and designs that are central to a firm's business and that remain unknown to competitors. Everyone loves a good mystery, so it is no surprise that legends have arisen around some trade secrets. Some examples and key issues surrounding trade secrets are illustrated below.

<p>Low-end fast food chain Long John Silver's considers its "crumblyies" (small bits of fried batter) to be a trade secret, but would anyone really want to solve the mystery?</p>	<p>In 2006, Pepsi was offered a chance to buy a stolen copy of Coca-Cola's secret recipe. An FBI sting was created and the thieves were arrested.</p>	<p>WD-40 was developed to repel water and prevent corrosion, but it was later found to have over two thousand uses. Creating WD-40 took a lot of work: the product's unusual name stands for "Water Displacement, 40th attempt." Despite being created in 1953, the formula for making WD-40 remains unknown outside the company that sells it.</p>
<p>FarmVille creator Zynga alleged in a lawsuit that Disney had lured away Zynga employees to work for Disney and then urged the employees to turn over a secret "playbook" that described Zynga's strategy. The case was settled out of court in late 2010.</p>	<p>In a 1995 episode of the hit comedy <i>Seinfeld</i>, a very successful but mean-spirited restaurateur nicknamed the "Soup Nazi" saw his business collapse when his secret recipes were revealed to customers. Individuals could now make delicious soups at home rather than endure the Soup Nazi's verbal abuse when buying soup.</p>	

Some trade secrets have become legendary, perhaps because a mystique arises around the unknown. One famous example is the blend of eleven herbs and spices used in Kentucky Fried Chicken's original recipe chicken. KFC protects this secret by having multiple suppliers each produce a portion of the herb and spice blend; no one supplier knows the full recipe. The formulation of Coca-Cola is also shrouded in mystery. In 2006, Pepsi was approached by shady individuals who were offering a chance to buy a stolen copy of Coca-Cola's secret recipe. Pepsi wisely refused. An FBI sting was used to bring the thieves to justice. The soft-drink industry has other secrets too. Dr Pepper's recipe remains unknown outside the company. Although Coke's formula has been the subject of greater speculation, Dr Pepper is actually the original secret soft drink; it was created a year before Coca-Cola.



The recipe for Dr Pepper is a secret dating back to the 1880s.

anyjazz65 – [Dr. Pepper](#) – CC BY 2.0.

Key Takeaway

- Intellectual property can serve as a strategic resource for organizations. While some sources of intellectual property such as patents, trademarks, and copyrights can receive special legal protection, trade secrets provide competitive advantages by simply staying hidden from competitors.

Exercises

1. What designs for your college or university are protected by trademarks?
2. What type of intellectual property provides the most protection for firms?
3. Why would a firm protect a resource through trade secret rather than by a formal patent?

References

Ward, C. 2009, October 8. OU works to prevent trademark infringement. *The Oklahoma Daily*. Retrieved from <http://www.oudaily.com/news/2009/oct/08/ou-works-prevent-trademark-infringement>.

4.4 Value Chain

Learning Objectives

1. Define the primary activities of the value chain.
2. Know the different support activities within the value chain.
3. Be able to apply the value chain to an organization of your choosing.
4. Understand the difference between a value chain and supply chain.

Table 4.10 Adding Value within a Value Chain

Doughnut shops buy commodity products (such as flour and grease) and transform them into delectable treats. Consumers are willing to pay much more for doughnuts than they would for flour and grease. Below we illustrate how primary and support activities in the value chain can add value for doughnut shops.

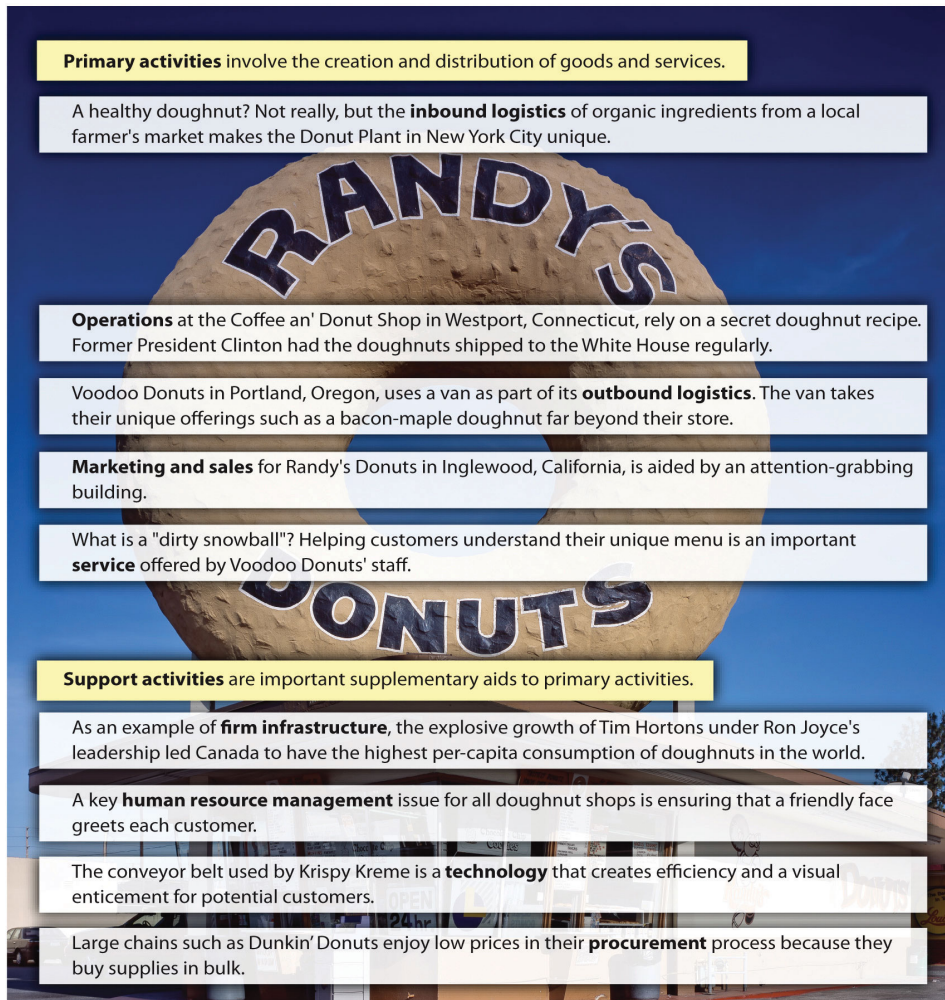

[Wikimedia Commons](#) – public domain.

Elements of the Value Chain

When executives choose strategies, an organization's resources and capabilities should be examined alongside consideration of its **value chain**. A value chain charts the path by which products and services are created and eventually sold to customers (Porter, 1985). The term *value chain* reflects the fact that, as each step of this path is completed, the product becomes more valuable than it was at the previous step (Table 4.10 "Adding Value within a Value Chain"). Within the lumber business, for example, value is added when a tree is transformed into usable wooden boards; the boards created from a tree can be sold for more money than the price of the tree.

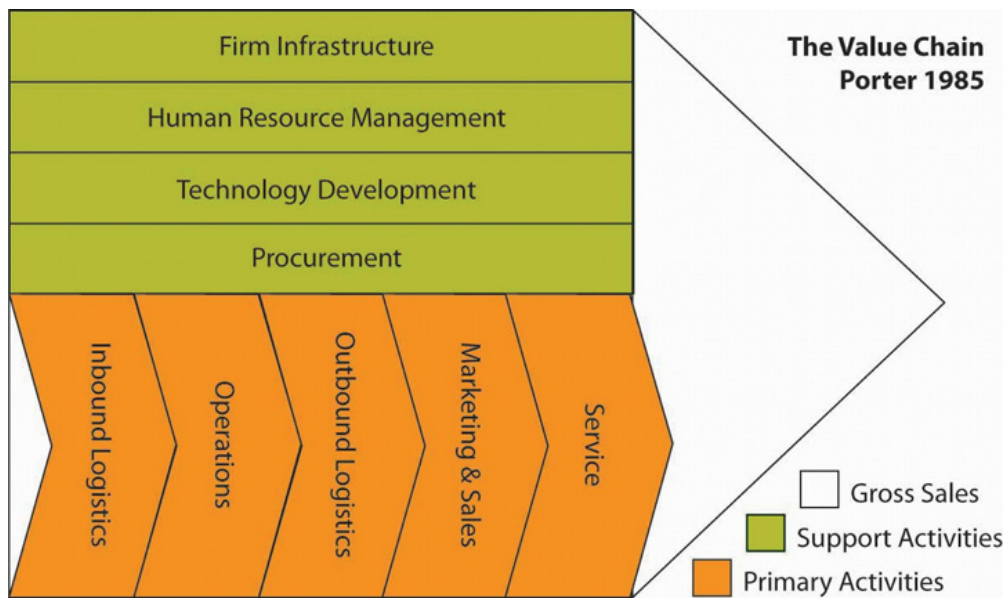

The Value Chain

Value chains include both primary and secondary activities. **Primary activities** are actions that are directly involved in creating and distributing goods and services. Consider a simple illustrative example: doughnut shops. Doughnut shops transform basic commodity products such as flour, sugar, butter, and grease into delectable treats. Value is added through this process because consumers are willing to pay much more for doughnuts than they would be willing to pay for the underlying ingredients.

There are five primary activities. **Inbound logistics** refers to the arrival of raw materials. Although doughnuts are seen by most consumers as notoriously unhealthy, the Doughnut Plant in New York City has carved out a unique niche for itself by obtaining organic ingredients from a local farmer's market. **Operations** refers to the actual production process, while outbound logistics tracks the movement of a finished product to customers. One of Southwest Airlines' unique capabilities is moving passengers more quickly than its rivals. This advantage in operations is based in part on Southwest's reliance on one type of airplane (which speeds maintenance) and its avoidance of advance seat assignments (which accelerates the passenger boarding process).

Attracting potential customers and convincing them to make purchases is the domain of **marketing and sales**. For example, people cannot help but notice Randy's Donuts in Inglewood, California, because the building has a giant doughnut on top of it. Finally, **service** refers to the extent to which a firm provides assistance to their customers. Voodoo Donuts in Portland, Oregon, has developed a clever website (voodoodoughnut.com) that helps customers understand their uniquely named products, such as the Voodoo Doll, the Texas Challenge, the Memphis Mafia, and the Dirty Snowball.

Secondary activities are not directly involved in the evolution of a product but instead provide important underlying support for primary activities. **Firm infrastructure** refers to how the firm is organized and led by executives. The effects of this organizing and leadership can be profound. For example, Ron Joyce's leadership of Canadian doughnut shop chain Tim Hortons was so successful that Canadians consume more doughnuts per person than all other countries. In terms of resource-based theory, Joyce's leadership was clearly a valuable and rare resource that helped his firm prosper.

Also important is **human resource management**, which involves the recruitment, training, and compensation of employees. A recent research study used data from more than twelve thousand organizations to demonstrate that the knowledge, skills, and abilities of a firm's employees can act as a strategic resource and strongly influence the firm's performance (Crook, et. al., 2011). Certainly, the unique level of dedication demonstrated by employees at Southwest Airlines has contributed to that firm's excellent performance over several decades.

Technology refers to the use of computerization and telecommunications to support primary activities. Although doughnut making is not a high-tech business, technology plays a variety of roles for doughnut shops, such as allowing customers to use credit cards. **Procurement** is the process of negotiating for and purchasing raw materials. Large doughnut chains such as Dunkin' Donuts and Krispy Kreme can gain cost advantages over their smaller rivals by purchasing flour, sugar, and other ingredients in bulk. Meanwhile, Southwest Airlines has gained an advantage over its rivals by using futures contracts within its procurement process to minimize the effects of rising fuel prices.

From the Value Chain to Best Value Supply Chains

"Time is money!" warns a famous saying. This simple yet profound statement suggests that organizations that quickly complete their work will enjoy greater profits, while slower-moving firms will suffer. The belief that time is money has encouraged the modern emphasis on supply chain management. A **supply chain** is a system of people, activities, information, and resources involved in creating a product and moving it to the customer. A supply chain is a broader concept than a value chain; the latter refers to activities within one firm, while the former captures the entire process of creating and distributing a product, often across several firms.

Competition in the twenty-first century requires an approach that considers the supply chain concept in tandem with the value-creation process within a firm: **best value supply chains**. These chains do not fixate on speed or on any other single metric. Instead, relative to their peers, best value supply chains focus on the total value added to the customer.

Creating best value supply chains requires four components. The first is **strategic supply chain management**—the use of supply chains as a means to create competitive advantages and enhance firm performance. Such an approach contradicts the popular wisdom centered on the need to maximize speed. Instead, there is recognition that the fastest chain may not satisfy customers' needs. Best value supply chains strive to excel along four measures. **Speed (or "cycle time")** is the time duration from initiation to completion of the production and distribution process. **Quality** refers to the relative reliability of supply chain activities. Supply chains' efforts at managing **cost** involve enhancing value by either reducing expenses or increasing customer benefits for the same cost level. **Flexibility** refers to a supply chain's responsiveness to changes in customers' needs. Through balancing these four metrics, best value supply chains attempt to provide the highest level of total value added.

The value of strategic supply chain management is reflected in how firms such as Walmart have used their supply chains as competitive weapons to gain advantages over peers. Walmart excels in terms of speed and cost by locating all domestic stores within one day's drive of a warehouse while owning a trucking fleet. This creates distribution speed and economies of scale that competitors simply cannot match. When Kmart's executives decided in the late 1990s to compete head-to-head with Walmart on price, Walmart's sophisticated logistics system enabled it to easily withstand the price war. Unable to match its rival's speed and costs, Kmart soon plunged into bankruptcy. Walmart's supply chains also possess strong quality and flexibility. When Hurricane Katrina devastated the Gulf Coast in 2005, Walmart used not only its warehouses and trucks but also its satellite technology, radio frequency identification (RFID), and global positioning systems to quickly divert assets to affected areas. The result was that Walmart emerged as the first responder in many towns and provided essentials such as drinking water faster than local and federal governments could.

Meanwhile, failing to manage a supply chain effectively causes serious harm. For example, in 2003 Motorola was unable to meet demand for its new camera phones because it did not have enough lenses available. Also, firms whose supply chains were centered in the Port of Los Angeles collectively lost more than \$2 billion a day during a 2002 workers' strike. In terms of stock price, firms' market value erodes by an average of 10 percent following the announcement of a major supply chain problem.

The second component is **agility**, the supply chain's relative capacity to act rapidly in response to dramatic changes in supply and demand (Lee, 2004). Agility can be achieved using buffers. Excess capacity, inventory, and management information systems all provide buffers that better enable a best value supply chain to service and to be more responsive to its customers. Rapid improvements and decreased costs in deploying information systems have enabled supply chains in recent years to reduce inventory as a buffer. Much popular thinking depicts inventory reduction as a goal in and of itself. However, this cannot occur without corresponding increases in buffer capacity elsewhere in the chain, or

performance will suffer. A best value supply chain seeks to optimize the total costs of all buffers used. The costs of deploying each buffer differs across industries; therefore, no solution that works for one company can be directly applied to another in a different industry without adaptation.

Agility in a supply chain can also be improved and achieved by colocating with the customer. This arrangement creates an information flow that cannot be duplicated through other methods. Daily face-to-face contact for supply chain personnel enables quicker response times to customer demands due to the speed at which information can travel back and forth between the parties. Again, this buffer of increased and improved information flows comes at an expense, so executives seeking to build a best value supply chain will investigate the opportunity and determine whether this action optimizes total costs.

Adaptability refers to a willingness and capacity to reshape supply chains when necessary. Generally, creating one supply chain for a customer is desired because this helps minimize costs. Adaptable firms realize that this is not always a best value solution, however. For example, in the defense industry, the US Army requires one class of weapon simulators to be repaired within eight hours, while another class of items can be repaired and returned within one month. To service these varying requirements efficiently and effectively, Computer Science Corporation (the firm whose supply chains maintain the equipment) must devise adaptable supply chains. In this case, spare parts inventory is positioned in proximity to the class of simulators requiring quick turnaround, while the less-time-sensitive devices are sent to a centralized repair facility. This supply chain configuration allows Computer Science Corporation to satisfy customer demands while avoiding the excess costs that would be involved in localizing all repair activities.

In situations in which the interests of one firm in the chain and the chain as a whole conflict, most executives will choose an option that benefits their firm. This creates a need for alignment among chain members. **Alignment** refers to creating consistency in the interests of all participants in a supply chain. In many situations, this can be accomplished through carefully writing incentives into contracts. Collaborative forecasting with suppliers and customers can also help build alignment. Taking the time to sit together with participants in the supply chain to agree on anticipated business levels permits shared understanding and rapid information transfers between parties. This is particularly valuable when customer demand is uncertain, such as in the retail industry (Ketchen, et. al., 2008).

Key Takeaway

- The value chain provides a useful tool for managers to examine systematically where value may be added to their organizations. This tool is useful in that it examines key elements in the production of a good or service, as well as areas in which value may be added in support of those primary activities.

Exercises

1. If you were hired as a consultant for your university, what specific element of the value chain would you seek to improve first?
2. What local business in your town could be improved most dramatically by applying the value chain? Would improvements of primary or support activities help to improve this firm most? Could knowledge of strategic supply chain management add further value to this firm?

References

Crook, T. R., Todd, S. Y., Combs, J. G., Woehr, D. J., & Ketchen, D. J. 2011. Does human capital matter? A meta-analysis of the relationship between human capital and firm performance. *Journal of Applied Psychology*, 96(3), 443–456.

Ketchen, D. J., Rebarick, W., Hult, G. T., & Meyer, D. 2008. Best value supply chains: A key competitive weapon for the 21st century. *Business Horizons*, 51, 235–243.

Lee, H. L. 2004, October. The triple-A supply chain. *Harvard Business Review*, 83, 102–112.

Porter, M. E. 1985. *Competitive advantage: Creating and sustaining superior performance*. New York, NY: Free Press.

4.5 Beyond Resource-Based Theory: Other Views on Firm Performance

Learning Objectives

1. Be able to discuss other theories about firm success and failure beyond resource-based theory.
2. Be able to apply different theories to help explain competition in different industries.

Table 4.11 Other Theories about Firm Performance

Resource-based theory is currently perhaps the most popular way of explaining why some firms succeed and other fail, but it is far from the only explanation. Below we illustrate several other prominent theories using examples from the airline industry.

Enactment suggests that organizations can, in part, create their environment through outstanding strategies. This puts a firm in control of its destiny. Although no airline has ever been able to do so, Microsoft and Apple are two firms that seemed to have enacted their environments.

Environmental determinism contends that external factors drive a firm's fate. In its early days, the federal government controlled airlines' routes and prices. After the airline industry was deregulated in the late 1970s, a series of large airlines fell prey to bad environment conditions such as recession, overcapacity in the industry, and fuel shortages. Many industry experts claim that the demise of Braniff Airlines, and others was inevitable.

Institutional theory is interested in the extent to which firms copy each other's strategies. After American Airlines became the first major airline to create a frequent flyer program in 1981, its competitors quickly developed their own frequent flyer programs. In the late 2000s, a new idea of charging passengers to check their luggage was copied by one airline after another.

Transaction cost economics centers on whether it is cheaper for a firm to make or to buy the products that it needs. Choosing efficient options enhances profits. No airline has ever chosen "make" when needing new airplanes. Buying airplanes from Boeing or Airbus is much more efficient than would be trying to backwardly integrate into the airplane manufacturing business.

Although resource-based theory stands as perhaps the most popular explanation of why some organizations prosper while others do not, several other theories are popular. [Enactment](#) treats executives as the masters of their domains. Enactment contends that an organization can, at least in part, create an environment for itself that is beneficial to the organization. This is accomplished by putting strategies in place that reshape competitive conditions in a favorable way ([Table 4.11 "Other Theories about Firm Performance"](#)).

By the 1990s, Microsoft had been so successful at reshaping the software industry to its benefit that the firm was the subject of a lengthy antitrust investigation by the federal government. More recently, Apple has been able to reshape its environment by introducing products such as the iPhone and the iPad that transcend the traditional boundaries

between the cell phone, digital camera, music player, and computer businesses. No airline has ever been able to enact the environment, however, perhaps because the airline industry is so fragmented.

Environmental determinism offers a completely opposite view from enactment on why some firms succeed and others fail. Environmental determinism views organizations much like biological theories view animals—organizations (and animals) are very limited in their ability to adapt to the conditions around them. Thus just as harsh environmental changes are believed to have made dinosaurs extinct, changes in the business environment can destroy organizations regardless of how clever and insightful executives are.

Until 1978, the federal government regulated the airline industry by dictating what routes each airline would fly and what prices it would charge. Once these controls were removed, airlines were subjected to a series of negative environmental trends, including recession, overcapacity in the industry, new entrants, fierce price competition, and fuel shortages. Perhaps not surprisingly, dozens of airlines have been crushed by these conditions.

An old saying notes that “imitation is the sincerest form of flattery.” This flattery is the focus of **institutional theory**. In particular, institutional theory centers on the extent to which firms copy one another’s strategies. Consider, for example, fast-food hamburger restaurants. Innovations such as dollar menus and drive-through windows tend to be introduced by one firm and then duplicated by the others.

Airlines also seem to follow a “monkey see, monkey do” mentality. To build passenger loyalty, American Airlines introduced a frequent flyer program called AAdvantage in 1981. After flying a certain number of miles on American flights, AAdvantage members were rewarded with a free flight. The idea was to make passengers less likely to shop around for the cheapest ticket. Ironically, AAdvantage turned out to be not much of an advantage at all. Many of American’s rivals quickly developed their own frequent-flyer programs, and today most airlines reward frequent passengers. In recent years, ideas such as charging passengers to check their luggage and eliminating free food on flights have been copied by one airline after another.

Transaction cost economics is a theory that centers on just one element of business activity: whether it is cheaper for a firm to make or to buy the products that it needs. This is an important element, however, because choosing the more efficient option can enhance a firm’s profits. Automakers such as Ford and General Motors face a wide variety of make-or-buy decisions because so many different parts are needed to build cars and trucks. Sometimes Ford and GM make these products, and other times they purchase them from outside suppliers. These firms’ financial situations are improved when these decisions are made wisely and harmed when they are made poorly.

In contrast, airlines always buy (or rent) their airplanes. Large planes are generally bought from Boeing or Airbus, while modest-sized airliners are purchased from companies such as Brazil’s Embraer. It would be simply too costly for an airline to pursue a **backward integration strategy** and enter the airplane manufacturing business. Insights such as these are powerful enough that the creator of transaction cost economics, Professor Oliver Williamson, was awarded a Nobel Prize in Economic Sciences in 2009.

Each of these theories—enactment, environmental determinism, institutional theory, and transaction cost economics—is useful for understanding some situations and some important business decisions. Thus executives should keep these perspectives in mind as they attempt to lead their firms to greater levels of success. However, one important advantage that resource-based theory offers over the alternatives is that only resource-based theory does a good job of explaining firm performance across a wide variety of contexts. Thus resource-based theory offers the point of view of business that has the strongest value for most executives.

Key Takeaway

- Although resource-based theory is the dominant perspective to predict performance in the strategic management field, other theories exist to explain firm behavior. In some industries, explanations provided by these theories can be very convincing.

Exercises

1. What theory of the firm do you think best explains competition in the fast-food industry?
2. What is an example of an industry in which institutional theory seems to explain the behavior of firms?

4.6 SWOT Analysis

Learning Objectives

1. Understand what SWOT analysis is.
2. Learn how SWOT analysis can help organizations and individuals, and its limitations.

Table 4.12 SWOT

Chess master Bruce Pandolfini has noted the similarities between business and chess. In both arenas, you must understand your own abilities as well as your flaws. You must also know your opponents, try to anticipate their moves, and deal with considerable uncertainty. A very popular management tool that incorporates the idea of understanding the elements internal and external to the firm is SWOT (strengths, weaknesses, opportunities, and threats) analysis. Strengths and weaknesses are assessed by examining the firm, while opportunities and threats refer to external events and trends. These ideas can be applied to individuals too. Below we offer examples of each element of SWOT analysis for organizations and for individuals who are seeking employment.

SWOT point	Organizational Examples	Individual Examples
Strengths	Having high-levels of cash flow gives firms discretion to purchase new equipment if they wish to.	Strong technical and language skills, as well as previous work experience, can help individuals rise above the competition.
Weaknesses	Dubious leadership and CEO scandals have plagued some corporations in recent years.	Poor communication skills keep many job seekers from being hired into sales and supervisory positions.
Opportunities	The high cost of gasoline creates opportunities for substitute products based on alternative energy sources.	The U.S. economy is increasingly services based, suggesting that individuals can enjoy more opportunities in service firms.
Threats	Concerns about worldwide pollution are a threat to petroleum-based products.	A tight job market poses challenges to new graduates.

Five forces analysis examines the situation faced by the competitors in an industry. Strategic groups analysis narrows the focus by centering on subsets of these competitors whose strategies are similar. **SWOT analysis** takes an even narrower focus by centering on an individual firm. Specifically, SWOT analysis is a tool that considers a firm's strengths and weaknesses along with the opportunities and threats that exist in the firm's environment (Table 4.12 "SWOT").

Executives using SWOT analysis compare these internal and external factors to generate ideas about how their firm

might become more successful. In general, it is wise to focus on ideas that allow a firm to leverage its strengths, steer clear of or resolve its weaknesses, capitalize on opportunities, and protect itself against threats. For example, untapped overseas markets have presented potentially lucrative opportunities to Subway and other restaurant chains such as McDonald's and Kentucky Fried Chicken. Meanwhile, Subway's strengths include a well-established brand name and a simple business format that can easily be adapted to other cultures. In considering the opportunities offered by overseas markets and Subway's strengths, it is not surprising that entering and expanding in different countries has been a key element of Subway's strategy in recent years. Indeed, Subway currently has operations in nearly 100 nations.



China's huge population and growing wealth makes it an attractive opportunity for Subway and other American restaurant chains.

Johnathan – Nanjing Lu – CC BY-NC-ND 2.0.

SWOT analysis is helpful to executives, and it is used within most organizations. Important cautions need to be offered about SWOT analysis, however. First, in laying out each of the four elements of SWOT, internal and external factors should not be confused with each other. It is important not to list strengths as opportunities, for example, if executives are to succeed at matching internal and external concerns during the idea generation process. Second, opportunities should not be confused with strategic moves designed to capitalize on these opportunities. In the case of Subway, it would be a mistake to list "entering new countries" as an opportunity. Instead, untapped markets are the opportunity presented to Subway, and entering those markets is a way for Subway to exploit the opportunity. Finally, and perhaps most important, the results of SWOT analysis should not be overemphasized. SWOT analysis is a relatively simple tool for understanding a firm's situation. As a result, SWOT is best viewed as a brainstorming technique for generating creative ideas, not as a rigorous method for selecting strategies. Thus the ideas produced by SWOT analysis offer a starting point for executives' efforts to craft strategies for their organization, not an ending point.

In addition to organizations, individuals can benefit from applying SWOT analysis to their personal situation. A college student who is approaching graduation, for example, could lay out her main strengths and weaknesses and the opportunities and threats presented by the environment. Suppose, for instance, that this person enjoys and is good at helping others (a strength) but also has a rather short attention span (a weakness). Meanwhile, opportunities to work at a rehabilitation center or to pursue an advanced degree are available. Our hypothetical student might be wise to pursue

a job at the rehabilitation center (where her strength at helping others would be a powerful asset) rather than entering graduate school (where a lot of reading is required and her short attention span could undermine her studies).

Key Takeaway

- Executives using SWOT analysis compare internal strengths and weaknesses with external opportunities and threats to generate ideas about how their firm might become more successful. Ideas that allow a firm to leverage its strengths, steer clear of or resolve its weaknesses, capitalize on opportunities, and protect itself against threats are particularly helpful.

Exercises

1. What do each of the letters in SWOT represent?
2. What are your key strengths, and how might you build your own personal strategies for success around them?

4.7 Conclusion

This chapter explains key issues that executives face in managing resources to keep their firms competitive. Resource-based theory argues that firms will perform better when they assemble resources that are valuable, rare, difficult to imitate, and nonsubstitutable. When executives can successfully bundle organizational resources into unique capabilities, the firm is more likely to enjoy lasting success. Different forms of intellectual property—which include patents, trademarks, copyrights, and trade secrets—may also serve as strategic resources for firms. Examining a firm’s resources can be aided by the value chain, a tool that systematically examines primary and secondary activities in the creation of a good or service and by a knowledge of supply chain management that examines the value added of multiple firms working together. While resource-based theory provides a dominant view for examining the determinants of firm success, other perspectives provide insight for understanding specific behaviors of firms within an industry. Finally, SWOT analysis is a simple but powerful technique for examining the interactions between factors internal and external to the firm.

Exercises

1. Divide your class into four or eight groups, depending on the size of the class. Each group should search for a patent tied to a successful product, as well as a patent associated with a product that was not a commercial hit. Were there resources tied to the successful organization that the poor performer did not seem to attain?
2. This chapter discussed Southwest Airlines. Based on your reading of the chapter, how well has Southwest done in bundling together the resources recommended by resource-based theory? What theoretical perspective best explains the competitive actions of most firms in the airline industry?
3. Conduct a SWOT analysis of your college or university. Based on your analysis, what one strategic move should your school make first, and why?

Chapter 5: Selecting Business-Level Strategies

Chapter 5: Selecting Business-Level Strategies

5.1 Selecting Business-Level Strategies

5.2 Understanding Business-Level Strategy through “Generic Strategies”

5.3 Cost Leadership

5.4 Differentiation

5.5 Focused Cost Leadership and Focused Differentiation

5.6 Best-Cost Strategy

5.7 Stuck in the Middle

5.8 Conclusion

5.1 Selecting Business-Level Strategies

Learning Objectives

After reading this chapter, you should be able to understand and articulate answers to the following questions:

1. Why is an examination of generic strategies valuable?
2. What are the four main generic strategies?
3. What is a best-cost strategy?
4. What does it mean to be “stuck in the middle”?

The Competition Takes Aim at Target



Mike Mozart – [Target](#) – CC BY 2.0.

On January 13, 2011, Target Corporation announced its intentions to operate stores outside the United States for the first time. The plan called for Target to enter Canada by purchasing existing leases from a Canadian retailer and then opening 100 to 150 stores in 2013 and 2014.(Target, 2011) The chain already included more than 1,700 stores in forty-nine states. Given the close physical and cultural ties between the United States and Canada, entering the Canadian market seemed to be a logical move for Target.

In addition to making its initial move beyond the United States, Target had several other sources of pride in early 2011. The company claimed that 96 percent of American consumers recognized its signature logo, surpassing the percentages enjoyed by famous brands such as Apple and Nike. In March, *Fortune* magazine ranked Target twenty-second on its list of the “World’s Most Admired Companies.” In May, Target reported that its sales and

earnings for the first quarter of 2011 (sales: \$15.6 billion; earnings: \$689 million) were stronger than they had been in the first quarter of 2010 (sales: \$15.2 billion; earnings: \$671 million). Yet there were serious causes for concern, too. News stories in the second half of 2010 about Target's donations to political candidates had created controversy and unwanted publicity. And despite increasing sales and profits, Target's stock price fell about 20 percent during the first quarter of 2011.

Concern also surrounded Target's possible vulnerability to competition within the retail industry. Since its creation in the early 1960s, Target executives had carved out a lucrative position for the firm. Target offers relatively low prices on brand-name consumer staples such as cleaning supplies and paper products, but it also offers chic clothing and household goods. This unique combination helps Target to appeal to fairly affluent customers. Although Target counts many college students and senior citizens among its devotees, the typical Target shopper is forty-one years old and has a household income of about \$63,000 per year. Approximately 45 percent of Target customers have children at home, and about 48 percent have a college degree.¹ Perhaps the most tangible reflection of Target's upscale position among large retailers is the tendency of some customers to jokingly pronounce its name as if it were a French boutique: "Tar-zhay."

Target's lucrative position was far from guaranteed, however. Indeed, a variety of competitors seemed to be taking aim at Target. Retail chains such as Kohl's and Old Navy offered fashionable clothing at prices similar to Target's. Discounters like T.J. Maxx, Marshalls, and Ross offered designer clothing and chic household goods for prices that often were lower than Target's. Closeout stores such as Big Lots offered a limited selection of electronics, apparel, and household goods but at deeply discounted prices. All these stores threatened to steal business from Target.

Walmart was perhaps Target's most worrisome competitor. After some struggles in the 2000s, the mammoth retailer's performance was strong enough that it ranked well above Target on *Fortune's* list of the "World's Most Admired Companies" (eleventh vs. twenty-second). Walmart also was much bigger than Target. The resulting economies of scale meant that Walmart could undercut Target's prices anytime it desired. Just such a scenario had unfolded before. A few years ago, Walmart's victory in a price war over Kmart led the latter into bankruptcy.

One important difference between Kmart and Target is that Target is viewed by consumers as offering relatively high-quality goods. But this difference might not protect Target. Although Walmart's products tended to lack the chic appeal of Target's, Walmart had begun offering better products during the recession of the late 2000s in an effort to expand its customer base. If Walmart executives chose to match Target's quality while charging lower prices, Target could find itself without a unique appeal for customers. As 2011 continued, a big question loomed: could Target maintain its unique appeal to customers or would the competitive arrows launched by Walmart and others force Target's executives to quiver?

¹Target fact card. 2007, January 2007. Retrieved from http://sites.target.com/images/corporate/about/pdfs/corp_factcard_101107.pdf

References

Target, Target Corporation to acquire interest in Canadian real estate from Zellers Inc., a subsidiary of Hudson's Bay Company, for C\$1.825 billion [Press release]. 2011, January 13. Target Stores. Retrieved from <http://pressroom.target.com/pr/news/target-corporation-to-acquire-real-estate.aspx>

5.2 Understanding Business-Level Strategy through “Generic Strategies”

Learning Objectives

1. Understand the four primary generic strategies.
2. Know the two dimensions that are critical to defining business-level strategy.
3. Know the limitations of generic strategies.

Why Examine Generic Strategies?

Business-level strategy addresses the question of how a firm will compete in a particular industry (Table 5.1 “Business-Level Strategies”). This seems to be a simple question on the surface, but it is actually quite complex. The reason is that there are a great many possible answers to the question. Consider, for example, the restaurants in your town or city. Chances are that you live fairly close to some combination of McDonald’s, Subway, Chili’s, Applebee’s, Panera Bread Company, dozens of other national brands, and a variety of locally based eateries that have just one location. Each of these restaurants competes using a business model that is at least somewhat unique. When an executive in the restaurant industry analyzes her company and her rivals, she needs to avoid getting distracted by all the nuances of different firm’s business-level strategies and losing sight of the big picture.

The solution is to think about business-level strategy in terms of generic strategies. A **generic strategy** is a general way of positioning a firm within an industry. Focusing on generic strategies allows executives to concentrate on the core elements of firms’ business-level strategies. The most popular set of generic strategies is based on the work of Professor Michael Porter of the Harvard Business School and subsequent researchers that have built on Porter’s initial ideas (Porter, 1980; Zeng, 2009).

Table 5.1 Business-Level Strategies

Firms compete on two general dimensions — the source of competitive advantage (cost or uniqueness) and the scope of operations (broad or narrow). Four possible generic business-level strategies emerge from these decisions. An example of each generic business-level strategy from the retail industry is illustrated below.

	Competitive Advantage: Cost	Competitive Advantage: Uniqueness
Scope of Operations: Broad Target	Walmart’s cost leadership strategy depends on attracting a large customer base and keeping prices low by buying massive quantities of goods from suppliers.	Nordstrom builds its differentiation strategy around offering designer merchandise and providing exceptional service.
Scope of Operations: Narrow Target	In using a focused cost leadership , Dollar General does not offer a full array of consumer goods, but those that it does offer are priced to move.	Anthropologie follows a focused differentiation strategy by selling unique (and pricey) women’s apparel, accessories, and home furnishings.

According to Porter, two competitive dimensions are the keys to business-level strategy. The first dimension is a firm’s source of competitive advantage. This dimension involves whether a firm tries to gain an edge on rivals by keeping costs down or by offering something unique in the market. The second dimension is firms’ scope of operations. This dimension involves whether a firm tries to target customers in general or whether it seeks to attract just a segment of customers. Four generic business-level strategies emerge from these decisions: (1) cost leadership, (2) differentiation, (3) focused cost leadership, and (4) focused differentiation. In rare cases, firms are able to offer both low prices and unique features that customers find desirable. These firms are following a best-cost strategy. Firms that are not able to offer low prices or appealing unique features are referred to as “stuck in the middle.”

Understanding the differences that underlie generic strategies is important because different generic strategies offer different value propositions to customers. A firm focusing on cost leadership will have a different value chain configuration than a firm whose strategy focuses on differentiation. For example, marketing and sales for a differentiation strategy often requires extensive effort while some firms that follow cost leadership such as Waffle House are successful with limited marketing efforts. This chapter presents each generic strategy and the “recipe” generally associated with success when using that strategy. When firms follow these recipes, the result can be a strategy that leads to superior performance. But when firms fail to follow logical actions associated with each strategy, the result may be a value proposition configuration that is expensive to implement and that does not satisfy enough customers to be viable.



Analyzing generic strategies enhances the understanding of how firms compete at the business level.

Limitations of Generic Strategies

Examining business-level strategy in terms of generic strategies has limitations. Firms that follow a particular generic strategy tend to share certain features. For example, one way that cost leaders generally keep costs low is by not spending much on advertising. Not every cost leader, however, follows this path. While cost leaders such as Waffle House spend very little on advertising, Walmart spends considerable money on print and television advertising despite following a cost leadership strategy. Thus a firm may not match every characteristic that its generic strategy entails. Indeed, depending on the nature of a firm's industry, tweaking the recipe of a generic strategy may be essential to cooking up success.

Key Takeaway

- Business-level strategies examine how firms compete in a given industry. Firms derive such strategies by executives making decisions about whether their source of competitive advantage is based on price or differentiation and whether their scope of operations targets a broad or narrow market.

Exercises

1. What are examples of each generic business-level strategy in the apparel industry?
2. What are the limitations of examining firms in terms of generic strategies?
3. Create a new framework to examine generic strategies using different dimensions than the two offered by Porter’s framework. What does your approach offer that Porter’s does not?

References

- Porter, M. E. 1980. *Competitive strategy: Techniques for analyzing industries and competitors*. New York, NY: Free Press;
- Williamson, P. J., &
Zeng, M. 2009. Value-for-money strategies for recessionary times. *Harvard Business Review*, 87(3), 66–74.

5.3 Cost Leadership

Learning Objectives

1. Describe the nature of cost leadership.
2. Understand how economies of scale help contribute to a cost leadership strategy.
3. Know the advantages and disadvantages of a cost leadership strategy.

Table 5.2 Cost Leadership

Firms that compete based on price and target a broad target market are following a cost leadership strategy. Several examples of firms pursuing a cost leadership strategy are illustrated below.

Despite its name, Dunkin' Donuts makes more money selling inexpensive coffee than it does from selling donuts. The coffee is often advertised as costing under a dollar, making Dunkin' Donuts a low-priced alternative to Starbucks.	Payless ShoeSource is a discount retailer that sells inexpensive shoes for men, women, and children. Their advertising slogans such as "Why pay more when you can Payless?" and "You could pay more, buy why?" consistently preach a low-price message.
Supercuts' website makes clear their longstanding cost leadership strategy by noting, "A Supercut is a haircut that has kept people looking their best, while keeping money in their pockets, since 1975."	Little Debbie snack cakes began when O.D. McKee started selling treats for five cents each in the early 1930s. Little Debbie cakes cost a lot more than five cents today, but they remain cheaper than similar offerings from Entenmann's, Tastykake, and other snack cake rivals.

The Nature of the Cost Leadership Strategy

It is tempting to think of cost leaders as companies that sell inferior, poor-quality goods and services for rock-bottom prices. The Yugo, for example, was an extremely unreliable car that was made in Eastern Europe and sold in the United States for about \$4,000. Despite its attractive price tag, the Yugo was a dismal failure because drivers simply could not depend on the car for transportation. Yugo exited the United States in the early 1990s and closed down entirely in 2008.

In contrast to firms such as Yugo whose failure is inevitable, cost leaders can be very successful. A firm following a [cost leadership](#) strategy offers products or services with acceptable quality and features to a broad set of customers at a low price ([Table 5.2 "Cost Leadership"](#)). Payless ShoeSource, for example, sells name-brand shoes at inexpensive prices. Its low-price strategy is communicated to customers through advertising slogans such as "Why pay more when you can Payless?" and "You could pay more, but why?" Little Debbie snack cakes offer another example. The brand was started in the 1930s when O. D. McKee began selling sugary treats for five cents. Most consumers today would view the quality of Little Debbie cakes as a step below similar offerings from Entenmann's, but enough people believe that they offer acceptable quality that the brand is still around eight decades after its creation.



Listeners of the popular radio show *Car Talk* voted the Yugo as the “worst car of the millennium.”

[Wikimedia Commons](#) – public domain.

Perhaps the most famous cost leader is Walmart, which has used a cost leadership strategy to become the largest company in the world. The firm’s advertising slogans such as “Always Low Prices” and “Save Money. Live Better” communicate Walmart’s emphasis on price slashing to potential customers. Meanwhile, Walmart has the broadest customer base of any firm in the United States. Approximately one hundred million Americans visit a Walmart in a typical week (Zimmerman & Hudson, 2006). Incredibly, this means that roughly one-third of Americans are frequent Walmart customers. This huge customer base includes people from all demographic and social groups within society. Although most are simply typical Americans, the popular website <http://www.peopleofwalmart.com> features photos of some of the more outrageous characters that have been spotted in Walmart stores.

Cost leaders tend to share some important characteristics. The ability to charge low prices and still make a profit is challenging. Cost leaders manage to do so by emphasizing efficiency. At Waffle House restaurants, for example, customers are served cheap eats quickly to keep booths available for later customers. As part of the effort to be efficient, most cost leaders spend little on advertising, market research, or research and development. Waffle House, for example, limits its advertising to billboards along highways. Meanwhile, the simplicity of Waffle House’s menu requires little research and development.

Many cost leaders rely on **economies of scale** to achieve efficiency. Economies of scale are created when the costs of offering goods and services decreases as a firm is able to sell more items. This occurs because expenses are distributed across a greater number of items. Walmart spent approximately \$2 billion on advertising in 2008. This is a huge number, but Walmart is so large that its advertising expenses equal just a tiny fraction of its sales. Also, cost leaders are often large companies, which allows them to demand price concessions from their suppliers. Walmart is notorious for squeezing suppliers such as Procter & Gamble to sell goods to Walmart for lower and lower prices over time. The firm passes some of these savings to customers in the form of reduced prices in its stores.

Advantages and Disadvantages of Cost Leadership

Each generic strategy offers advantages that firms can potentially leverage to enhance their success as well as disadvantages that may undermine their success. In the case of cost leadership, one advantage is that cost leaders’ emphasis on efficiency makes them well positioned to withstand price competition from rivals (Table 5.3 “[Executing a Low-Cost Strategy](#)”). Kmart’s ill-fated attempt to engage Walmart in a price war ended in disaster, in part because Walmart was so efficient in its operations that it could live with smaller profit margins far more easily than Kmart could.

Table 5.3 Executing a Low-Cost Strategy

Using a cost leadership strategy offers firms important advantages and disadvantages. Below we illustrate a few examples in relation to entertainment and leisure.

Advantages	<p>High profits can be enjoyed if a cost leader has a high market share. An example is Kampgrounds of America, a chain of nearly 500 low cost camping franchises in the United States.</p> <p>Low-cost firms such as many municipal golf courses can withstand price wars because high-priced competitors will not want to compete directly with a more efficient rival.</p>
Disadvantages	<p>If perceptions of quality become too low, business will suffer.</p> <p>Large volumes of sales are a must because margins are slim.</p> <p>The need to keep expenses low might lead cost leaders to be late in detecting key environment trends.</p> <p>Low-cost firms' emphasis on efficiency makes it difficult for them to change quickly if needed.</p>

Beyond existing competitors, a cost leadership strategy also creates benefits relative to potential new entrants. Specifically, the presence of a cost leader in an industry tends to discourage new firms from entering the business because a new firm would struggle to attract customers by undercutting the cost leaders' prices. Thus a cost leadership strategy helps create barriers to entry that protect the firm—and its existing rivals—from new competition.



Challenging a cost leader in a price war may end up destroying a company.

WFIU Public Radio – [Closed Sign](#) – CC BY-NC 2.0.

In many settings, cost leaders attract a large market share because a large portion of potential customers find paying low prices for goods and services of acceptable quality to be very appealing. This is certainly true for Walmart, for example. The need for efficiency means that cost leaders' profit margins are often slimmer than the margins enjoyed

by other firms. However, cost leaders' ability to make a little bit of profit from each of a large number of customers means that the total profits of cost leaders can be substantial.

In some settings, the need for high sales volume is a critical disadvantage of a cost leadership strategy. Highly fragmented markets and markets that involve a lot of brand loyalty may not offer much of an opportunity to attract a large segment of customers. In both the soft drink and cigarette industries, for example, customers appear to be willing to pay a little extra to enjoy the brand of their choice. Lower-end brands of soda and cigarettes appeal to a minority of consumers, but famous brands such as Coca-Cola, Pepsi, Marlboro, and Camel still dominate these markets. A related concern is that achieving a high sales volume usually requires significant upfront investments in production and/or distribution capacity. Not every firm is willing and able to make such investments.

Cost leaders tend to keep their costs low by minimizing advertising, market research, and research and development, but this approach can prove to be expensive in the long run. A relative lack of market research can lead cost leaders to be less skilled than other firms at detecting important environmental changes. Meanwhile, downplaying research and development can slow cost leaders' ability to respond to changes once they are detected. Lagging rivals in terms of detecting and reacting to external shifts can prove to be a deadly combination that leaves cost leaders out of touch with the market and out of answers.

Key Takeaway

- Cost leadership is an effective business-level strategy to the extent that a firm offers low prices, provides satisfactory quality, and attracts enough customers to be profitable.

Exercises

1. What are three industries in which a cost leadership strategy would be difficult to implement?
2. What is your favorite cost leadership restaurant?
3. Name three examples of firms conducting a cost leadership strategy that use no advertising. Should they start advertising? Why or why not?

References

Zimmerman, Ann and Kris Hudson, "Managing Wal-Mart: How US-store chief hopes to fix Wal-Mart," *Wall Street Journal*, April 17, 2006.

5.4 Differentiation

Table 5.4 Differentiation

Firms that compete on uniqueness and target a broad market are following a differentiation strategy. Several examples of firms pursuing a differentiation strategy are illustrate below.

Although salt is a commodity, Morton has differentiated its salt by building a brand around its iconic umbrella girl and its trademark slogan of “When it rains, it pours.”
FedEx’s former slogan “When it absolutely, positively has to be there overnight” highlights the commitment to very speedy delivery that differentiates them from competitors such as UPS and the U.S. Postal Service.
Offering such as Hot Wheels cars and the Barbie line of dolls highlight toy maker Mattel’s differentiation strategy. Both are updated regularly to reflect current trends and tastes.
Nike differentiates its athletic shoes through its iconic “swoosh” as well as an intense emphasis on product innovation through research and development.
The Walt Disney Company has developed numerous well-known characters such as Mickey Mouse, the Little Mermaid, and Captain Jack Sparrow that help differentiate their movies, theme parks, and merchandise.

Learning Objectives

1. Describe the nature of differentiation.
2. Know the advantages and disadvantages of a differentiation strategy.

The Nature of the Differentiation Strategy

A famous cliché contends that “you get what you pay for.” This saying captures the essence of a differentiation strategy. A firm following a [differentiation strategy](#) attempts to convince customers to pay a premium price for its good or services by providing unique and desirable features (Table 5.4 “Differentiation”). The message that such a firm conveys to customers is that you will pay a little bit more for our offerings, but you will receive a good value overall because our offerings provide something special.

In terms of the two competitive dimensions described by Michael Porter, using a differentiation strategy means that a firm is competing based on uniqueness rather than price and is seeking to attract a broad market (Porter, 1980). Coleman camping equipment offers a good example. If camping equipment such as sleeping bags, lanterns, and stoves fail during a camping trip, the result will be, well, unhappy campers. Coleman’s sleeping bags, lanterns, and stoves are renowned for their reliability and durability. Cheaper brands are much more likely to have problems. Lovers of the

outdoors must pay more to purchase Coleman's goods than they would to obtain lesser brands, but having equipment that you can count on to keep you warm and dry is worth a price premium in the minds of most campers.

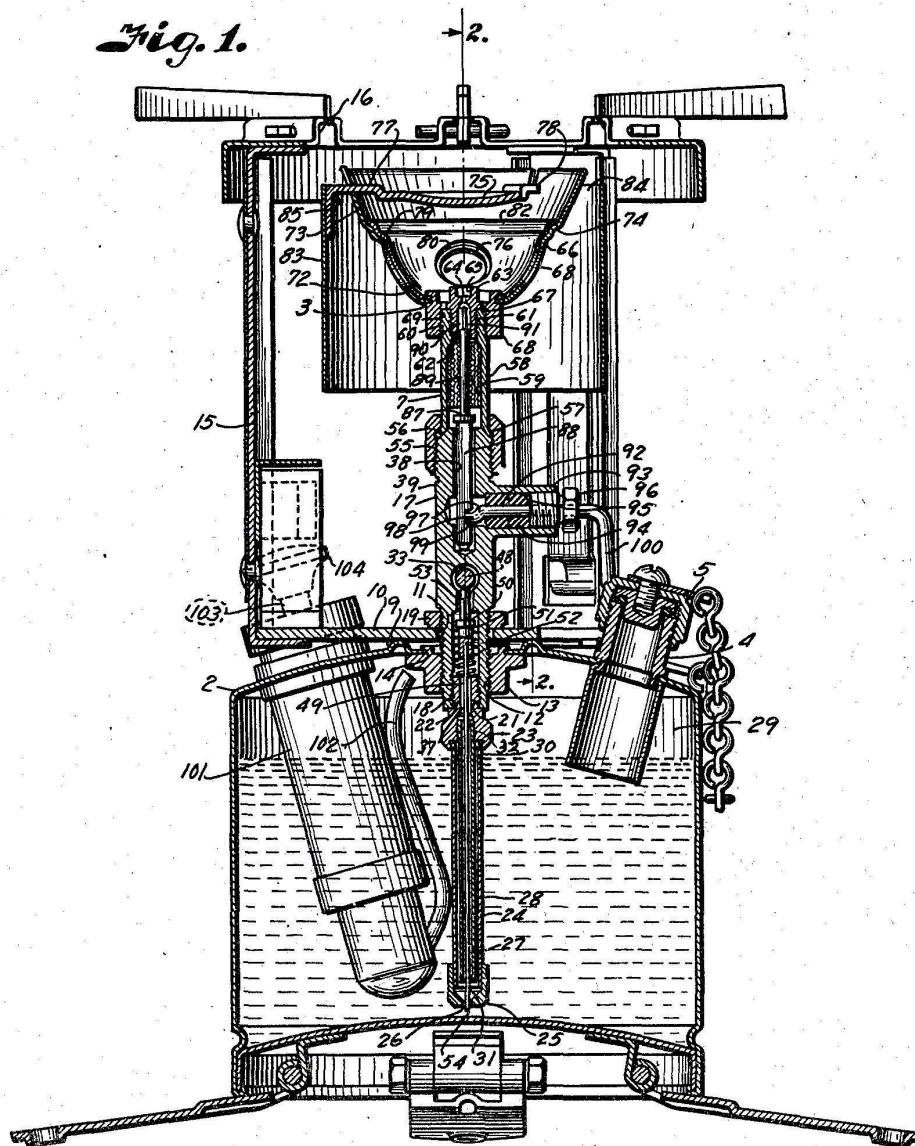

Coleman's patented stove was originally developed for use by soldiers during World War II. Seven decades later, the Coleman Stove remains a must-have item for campers.

Successful use of a differentiation strategy depends on not only offering unique features but also communicating the value of these features to potential customers. As a result, advertising in general and brand building in particular are important to this strategy. Few goods are more basic and generic than table salt. This would seemingly make creating a differentiated brand in the salt business next to impossible. Through clever marketing, however, Morton Salt has done so. Morton has differentiated its salt by building a brand around its iconic umbrella girl and its trademark slogan of "When it rains, it pours." Would the typical consumer be able to tell the difference between Morton Salt and cheaper

generic salt in a blind taste test? Not a chance. Yet Morton succeeds in convincing customers to pay a little extra for its salt through its brand-building efforts.

FedEx and Nike are two other companies that have done well at communicating to customers that they provide differentiated offerings. FedEx's former slogan "When it absolutely, positively has to be there overnight" highlights the commitment to speedy delivery that sets the firm apart from competitors such as UPS and the US Postal Service. Nike differentiates its athletic shoes and apparel through its iconic "swoosh" logo as well as an intense emphasis on product innovation through research and development.

Developing a Differentiation Strategy at Express Oil Change

Express Oil Change and Service Centers is a chain of auto repair shops that stretches from Florida to Texas. Based in Birmingham, Alabama, the firm has more than 170 company-owned and franchised locations under its brand. Express Oil Change tries to provide a unique level of service, and the firm is content to let rivals offer cheaper prices. We asked an Express Oil Change executive about his firm (Ketchen & Short, 2010).

Question:

The auto repair and maintenance business is a pretty competitive space. How is Express Oil Change being positioned relative to other firms, such as Super Lube, American LubeFast, and Jiffy Lube?

Don Larose, Senior Vice President of Franchise Development:

Every good business sector is competitive. The key to our success is to be more convenient and provide a better overall experience for the customer. Express Oil Change and Service Centers outperform the industry significantly in terms of customer transactions per day and store sales, for a host of reasons.

In terms of customer convenience, Express Oil Change is faster than most of our competitors—we do a ten-minute oil change while the customer stays in the car. Mothers with kids in car seats especially enjoy this feature. We also do mechanical work that other quick lube businesses don't do. We change and rotate tires, do brake repairs, air conditioning, tune ups, and others. There is no appointment necessary for many mechanical services like tire rotation and balancing, and checking brakes. So, overall, we are more convenient than most of our competitors.

In terms of staffing our stores, full-time workers are all that we employ. Full-time workers are better trained and typically have less turnover. They therefore have more experience and do better quality work.

We think incentives are very important. We use a payroll system that provides incentives to the store staff on how many cars are serviced each day and on the total sales of the store, rather than on increasing the average transactions by selling the customer items they did not come in for, which is what most of the industry does. We don't sell customers things they don't yet need, like air filters and radiator flushes. We focus on building trust, by acting with integrity, to get the customer to come back and build the daily car count. This philosophy is not a slogan for us. It is how we operate with every customer, in every store, every day.

The placement of our outlets is another key factor. We place our stores in A-caliber retail locations. These are lots that may cost more than our competitors are willing or able to pay. We get what we pay for though; we have approximately 41% higher sales per store than the industry average.

Question:

What is the strangest interaction you've ever had with a potential franchisee?

Larose:

I once had a franchisee candidate in New Jersey respond to a request by us for proof of his liquid assets by bringing to the interview about \$100,000 in cash to the meeting. He had it in a bag, with bundles of it wrapped in blue tape. Usually, folks just bring in a copy of a bank or stock statement. Not sure why he had so much cash on hand, literally, and I didn't want to know. He didn't become a franchisee.



Express Oil Change sets itself apart through superior service and great locations.

Dystopos – [Express Oil Change](#) – CC BY-NC 2.0.

Table 5.5 Executing a Differentiation Strategy

A differentiation strategy offers important advantages and disadvantages for firms that adopt it. Below we illustrate a few examples in relation to an often differentiated product—women’s handbags.

Advantages	<i>Buyer loyalty</i> is common among handbag buyers. Many individuals enjoy seeing—and being seen with—a designer logo on the products they buy such as the iconic C that is shown on Coach bags.	Chanel enjoys <i>strong margins</i> because their well-known name allows them to charge a premium for their handbags.
Disadvantages	Less-expensive bags from retailers such as Target provide enough of a trendy look to satisfy many <i>price-sensitive buyers</i> . These individuals will choose to save their money by avoiding expensive bags from top-end designers.	<i>Imitations</i> may steal customers, such as is common with knock-off handbags sold by street vendors.

Advantages and Disadvantages of Differentiation

Each generic strategy offers advantages that firms can potentially leverage to enjoy strong performance, as well as disadvantages that may damage their performance. In the case of differentiation, a key advantage is that effective differentiation creates an ability to obtain premium prices from customers (Table 5.5 “Executing a Differentiation Strategy”). This enables a firm to enjoy strong profit margins. Coca-Cola, for example, currently enjoys a profit margin of approximately 33 percent, meaning that about thirty-three cents of every dollar it collects from customers is profit. In comparison, Walmart’s cost leadership strategy delivered a margin of under 4 percent in 2010.

In turn, strong margins mean that the firm does not need to attract huge numbers of customers to have a good overall level of profit. Luckily for Coca-Cola, the firm does attract a great many buyers. Overall, the firm made a profit of just under \$12 billion on sales of just over \$35 billion in 2010. Interestingly, Walmart’s profits were only 25 percent higher (\$15 billion) than Coca-Cola’s while its sales volume (\$421 billion) was twelve times as large as Coca-Cola’s.¹ This comparison of profit margins and overall profit levels illustrates why a differentiation strategy is so attractive to many firms.

To the extent that differentiation remains in place over time, buyer loyalty may be created. Loyal customers are very desirable because they are not **price sensitive**. In other words, buyer loyalty makes a customer unlikely to switch to another firm’s products if that firm tries to steal the customer away through lower prices. Many soda drinkers are fiercely loyal to Coca-Cola’s products. Coca-Cola’s headquarters are in Atlanta, and loyalty to the firm is especially strong in Georgia and surrounding states. Pepsi and other brands have a hard time convincing loyal Coca-Cola fans to buy their beverages, even when offering deep discounts. This helps keep Coca-Cola’s profits high because the firm does not have to match any promotions that its rivals launch to keep its customers.

Meanwhile, Pepsi also has attracted a large set of brand-loyal customers that Coca-Cola struggles to steal. This enhances Pepsi’s profits. In contrast, store-brand sodas such as Sam’s Choice (which is sold at Walmart) seldom attract loyalty. As a result, they must be offered at very low prices to move from store shelves into shopping carts.

Beyond existing competitors, a differentiation strategy also creates benefits relative to potential new entrants. Specifically, the brand loyalty that customers feel to a differentiated product makes it difficult for a new entrant to lure these customers to adopt its product. A new soda brand, for example, would struggle to take customers away from Coca-Cola or Pepsi. Thus a differentiation strategy helps create barriers to entry that protect the firm and its industry from new competition.

The big risk when using a differentiation strategy is that customers will not be willing to pay extra to obtain the unique features that a firm is trying to build its strategy around. In 2007, department store Dillard’s stopped carrying men’s sportswear made by Nautica because the seafaring theme of Nautica’s brand had lost much of its cache among many men (Kapner, 2007). Because Nautica’s uniqueness had eroded, Dillard’s believed that space in its stores that Nautica had been occupying could be better allocated to other brands.

In some cases, customers may simply prefer a cheaper alternative. For example, products that imitate the look and feel of offerings from Ray-Ban, Tommy Bahama, and Coach are attractive to many value-conscious consumers. Firms

such as these must work hard at product development and marketing to ensure that enough customers are willing to pay a premium for their goods rather than settling for knockoffs.

In other cases, customers desire the unique features that a firm offers, but competitors are able to imitate the features well enough that they are no longer unique. If this happens, customers have no reason to pay a premium for the firm's offerings. IBM experienced the pain of this scenario when executives tried to follow a differentiation strategy in the personal computer market. The strategy had worked for IBM in other areas. Specifically, IBM had enjoyed a great deal of success in the mainframe computer market by providing superior service and charging customers a premium for their mainframes. A business owner who relied on a mainframe to run her company could not afford to have her mainframe out of operation for long. Meanwhile, few businesses had the skills to fix their own mainframes. IBM's message to customers was that they would pay more for IBM's products but that this was a good investment because when a mainframe needed repairs, IBM would provide faster and better service than its competitors could. The customer would thus be open for business again very quickly after a mainframe failure.

This positioning failed when IBM used it in the personal computer market. Rivals such as Dell were able to offer service that was just as good as IBM's while also charging lower prices for personal computers than IBM charged. From a customer's perspective, a person would be foolish to pay more for an IBM personal computer since IBM did not offer anything unique. IBM steadily lost market share as a result. By 2005, IBM's struggles led it to sell its personal computer business to Lenovo. The firm is still successful, however, within the mainframe market where its offerings remain differentiated.



Firms following a differentiation strategy must “watch” out for counterfeit goods such as the faux Rolexes shown here.

[Wikimedia Commons](#) – public domain.

Key Takeaway

- Differentiation can be an effective business-level strategy to the extent that a firm offers unique features that convince customers to pay a premium for their goods and services.

Exercises

1. What are two industries in which a differentiation strategy would be difficult to implement?
2. What is an example of a differentiated business near your college or university?
3. Name three ways businesses that provide entertainment that might better differentiate their services. How might they do this?

¹Profit statistics drawn from Standard & Poor's stock reports on Coca-Cola and Walmart.

References

Kapner, S. 2007, November 1. Nautica brand losing ground. *CNNMoney*. Retrieved from http://money.cnn.com/2007/10/31/news/companies/Kapner_Nautica.fortune/index.htm.

Ketchen, D. J., & Short, J. C. 2010. The franchise player: An interview with Don Larose. *Journal of Applied Management and Entrepreneurship*, 15(4), 94–101.

Porter, M. E. 1980. *Competitive strategy: Techniques for analyzing industries and competitors*. New York, NY: Free Press.

5.5 Focused Cost Leadership and Focused Differentiation

Learning Objectives

1. Describe the nature of focused cost leadership and focused differentiation.
2. Know the advantages and disadvantages of focus strategies.

Companies that use a cost leadership strategy and those that use a differentiation strategy share one important characteristic: both groups try to be attractive to customers in general. These efforts to appeal to broad markets can be contrasted with strategies that involve targeting a relatively narrow niche of potential customers. These latter strategies are known as **focus strategies** (Porter, 1980).

The Nature of the Focus Cost Leadership Strategy

Focused cost leadership is the first of two focus strategies. A focused cost leadership strategy requires competing based on price to target a narrow market (Table 5.6 “Focused Cost Leadership”). A firm that follows this strategy does not necessarily charge the lowest prices in the industry. Instead, it charges low prices relative to other firms that compete within the target market. Redbox, for example, uses vending machines placed outside grocery stores and other retail outlets to rent DVDs of movies for \$1. There are ways to view movies even cheaper, such as through the flat-fee streaming video subscriptions offered by Netflix. But among firms that rent actual DVDs, Redbox offers unparalleled levels of low price and high convenience.

Table 5.6 Focused Cost Leadership

Firms that compete based on price and target a narrow market are following a focused cost leadership strategy. Several examples of firms pursuing a focused cost leadership strategy are illustrated below.

<p>Redbox rents DVDs and video games through vending machines for only \$1.</p>	<p>Papa Murphy’s targets its inexpensive take-and-bake pizzas at value-conscious families. Because the pizzas are baked at home rather than in the store, Papa Murphy’s is permitted to accept food stamps. This allows the firm to attract customers that might not otherwise be able to afford a restaurant-quality pizza.</p>
<p>Claire’s three thousand+ locations target young women with inexpensive jewelry, accessories, and ear piercings. The strategy has worked: Claire’s has over three thousand locations and has stores in 95 percent of U.S. shopping malls.</p>	<p>Providing indoor seating creates expenses for fast-food restaurants. Checkers Drive In keeps its costs low by not offering indoor seating. Checkers targets drive-thru customers and offers them big burgers at rock-bottom prices.</p>

Another important point is that the nature of the narrow target market varies across firms that use a focused cost

leadership strategy. In some cases, the target market is defined by demographics. Claire's, for example, seeks to appeal to young women by selling inexpensive jewelry, accessories, and ear piercings. Claire's use of a focused cost leadership strategy has been very successful; the firm has more than three thousand locations and has stores in 95 percent of US shopping malls.



Redbox machines are available on university campuses nationwide.

Valerie Everett – [A big mac and saving private ryan please](#) – CC BY-SA 2.0.

In other cases, the target market is defined by the sales channel used to reach customers. Most pizza shops offer sit-down service, delivery, or both. In contrast, Papa Murphy's sells pizzas that customers cook at home. Because these inexpensive pizzas are baked at home rather than in the store, the law allows Papa Murphy's to accept food stamps as payment. This allows Papa Murphy's to attract customers that might not otherwise be able to afford a prepared pizza. In contrast to most fast-food restaurants, Checkers Drive In is a drive-through-only operation. To serve customers quickly, each store has two drive-through lanes: one on either side of the building. Checkers saves money in a variety of ways by not offering indoor seating to its customers—Checkers' buildings are cheaper to construct, its utility costs are lower,

and fewer employees are needed. These savings allow the firm to offer large burgers at very low prices and still remain profitable.

The Nature of the Focused Differentiation Strategy

Focused differentiation is the second of two focus strategies. A focused differentiation strategy requires offering unique features that fulfill the demands of a narrow market (Table 5.7 “**Focused Differentiation**”). As with a focused low-cost strategy, narrow markets are defined in different ways in different settings. Some firms using a focused differentiation strategy concentrate their efforts on a particular sales channel, such as selling over the Internet only. Others target particular demographic groups. One example is Breezes Resorts, a company that caters to couples without children. The firm operates seven tropical resorts where vacationers are guaranteed that they will not be annoyed by loud and disruptive children.

While a differentiation strategy involves offering unique features that appeal to a variety of customers, the need to satisfy the desires of a narrow market means that the pursuit of uniqueness is often taken to the proverbial “next level” by firms using a focused differentiation strategy. Thus the unique features provided by firms following a focused differentiation strategy are often specialized.

Table 5.7 Focused Differentiation

Firms that compete based on uniqueness and target a narrow market are following a focused differentiations strategy. Several examples of firms pursuing a focused differentiation strategy are illustrated below.

<p>Whole Foods Market focuses on selling natural and organic products. The supermarket’s reputation for high prices has led to a wry nickname — “Whole Paycheck” — but a sizable number of consumers are willing to pay a premium in order to feel better about the food they are buying. After all, you are what you eat!</p>	<p>At Build-A-Bear Workshop, customers enjoy an interactive process of designing and assembling teddy bears. Build-A-Bear customers are willing to pay a premium price because they receive a unique, hands-on experience rather than simply buying a stuffed toy.</p>
<p>You can buy a cinnamon roll cheaper elsewhere, but Cinnabon’s pricey pastries are so delicious that sugar-obsessed snackers line up to buy them. Perhaps in a nod to Cinnabon’s strategy, the brand is owned by a parent company name Focus Brands.</p>	<p>The dedication of Mercedes-Benz to cutting-edge technology, styling, and safety innovations has made the firm’s vehicles prized by those who are rich enough to afford them.</p>

When it comes to uniqueness, few offerings can top Kopi Luwak coffee beans. High-quality coffee beans often sell for \$10 to \$15 a pound. In contrast, Kopi Luwak coffee beans sell for hundreds of dollars per pound (Cat’s Ass Coffee). This price is driven by the rarity of the beans and their rather bizarre nature. As noted in a 2010 article in the *New York Times*, these beans

are found in the droppings of the civet, a nocturnal, furry, long-tailed catlike animal that prowls Southeast Asia’s coffee-growing lands for the tastiest, ripest coffee cherries. The civet eventually excretes the hard, indigestible innards of the fruit—essentially, incipient coffee beans—though only after they have been fermented in the animal’s stomach acids and enzymes to produce a brew described as smooth, chocolatey and devoid of any bitter aftertaste (Onishi, 2010).

Although many consumers consider Kopi Luwak to be disgusting, a relatively small group of coffee enthusiasts has embraced the coffee and made it a profitable product. This illustrates the essence of a focused differentiation strategy—effectively serving the specialized needs of a niche market can create great riches.

Larger niches are served by Whole Foods Market and Mercedes-Benz. Although most grocery stores devote a section of their shelves to natural and organic products, Whole Foods Market works to sell such products exclusively. For customers, the large selection of organic goods comes at a steep price. Indeed, the supermarket's reputation for high prices has led to a wry nickname—"Whole Paycheck"—but a sizable number of consumers are willing to pay a premium to feel better about the food they buy.

The dedication of Mercedes-Benz to cutting-edge technology, styling, and safety innovations has made the firm's vehicles prized by those who are rich enough to afford them. This appeal has existing for many decades. In 1970, acid-rocker Janis Joplin recorded a song called "Mercedes Benz" that highlighted the automaker's allure. Since then Mercedes-Benz has used the song in several television commercials, including during the 2011 Super Bowl.



Janis Joplin's musical tribute to Mercedes-Benz underscores the allure of the brand.

[Wikimedia Commons](#) – CC BY-SA 2.0.

Developing a Focused Differentiation Strategy at Augustino LoPrinzi Guitars and Ukuleles

Augustino LoPrinzi Guitars and Ukuleles in Clearwater, Florida, builds high-end custom instruments. The founder of the company, Augustino LoPrinzi, has been a builder of custom guitars for five decades. While a reasonably good mass-produced guitar can be purchased elsewhere for a few hundred dollars, LoPrinzi's handmade models start at \$1,100, and some sell for more than \$10,000. The firm's customers have included professional musicians such as Dan Fogelberg, Leo Kottke, Herb Ohta (Ohta-San), Lyle Ritz, Andrés Segovia, and B. J. Thomas. Their instruments can be found at <http://www.augustinoloprinzi.com>. We asked Augustino about his firm (Short, 2007).

Question:

Were there other entrepreneurial opportunities you considered before you began making guitars?

Augustino Loprinzi:

I originally thought of pursuing a career in commercial art, but I found my true love was in classical guitar building. I was trained by my father to be a barber from a very young age, and after my term in the service, I opened a barbershop.

Question:

What is the most expensive guitar you've ever sold?

Loprinzi:

\$17,500.

Question:

How old were you when you started your first business in the guitar industry?

Loprinzi:

I was in my early twenties.

Question:

How did you get your break with more famous customers?

Loprinzi:

I think word of mouth had a lot to do with it.

Question:

You have been active in Japan. Do the preferences of Japanese customers differ from those of Americans?

Loprinzi:

Yes. The Japanese want only high-end instruments. Aesthetics are very important to the Japanese along with high-quality materials and workmanship. The US market seems to care in general less about ornamentation and more about quality workmanship, tone, and playability.

Question:

How do you stay ahead in your industry?

Loprinzi:

Always try to stay abreast on what the music industry is doing. We do this by reading several music industry publications, talking with suppliers, and keeping an eye on the trends going on in other countries because usually they come full circle. Also, for the past several years by following the Internet forums and such has been extremely beneficial.

Advantages and Disadvantages of the Focused Strategies

Each generic strategy offers advantages that firms can potentially leverage to enhance their success as well as disadvantages that may undermine their success. In the case of focus differentiation, one advantage is that very high prices can be charged. Indeed, these firms often price their wares far above what is charged by firms following a differentiation strategy (Table 5.8 “Executing a Focus Strategy”). REI (Recreational Equipment Inc.), for example, commands a hefty premium for its outdoor sporting goods and clothes that feature name brands, such as The North Face and Marmot. Nat Nast’s focus differentiation strategy centers on selling men’s silk camp shirts with a 1950s retro flair. These shirts retail for more than \$100. Focused cost leaders such as Checkers Drive In do not charge high prices like REI and Nat Nast do, but their low cost structures enable them to enjoy healthy profit margins.

A second advantage of using a focus strategy is that firms often develop tremendous expertise about the goods and services that they offer. In markets such as camping equipment where product knowledge is important, rivals and new entrants may find it difficult to compete with firms following a focus strategy.

Table 5.8 Executing a Focus Strategy

Using one of the focus strategies offers firms important advantages and disadvantages. Below we illustrate a few examples in relation to an industry where many different types of focus exist—sporting goods.

Advantages	Disadvantages
<p>High prices can be charged. Recreational Equipment Incorporated (REI), for example, commands a premium for their outdoor sporting goods and clothes that feature name brands such as The North Face and Marmot.</p> <p>Firms using a focus strategy often develop great expertise about the good or service being sold. Thus, customers may gravitate toward a specialty camping shop in order to learn how to best take advantage of limited vacation time.</p>	<p>Limited demands exist for specialized goods and services, so every potential sale counts.</p> <p>The area of focus may be taken over by others or even disappear over time. Many gun stores went out of business after large retailers such as Walmart started carrying an array of firearms.</p> <p>Other firms may provide an even narrower focus. An outdoor sporting goods store, for example, might lose business to a store that focuses solely on ski apparel because the latter can provide more guidance about how skiers can stay warm and avoid broken bones.</p>

In terms of disadvantages, the limited demand available within a niche can cause problems. First, a firm could find its growth ambitions stymied. Once its target market is being well served, expansion to other markets might be the only way to expand, and this often requires developing a new set of skills. Also, the niche could disappear or be taken over by larger competitors. Many gun stores have struggled and even gone out of business since Walmart and sporting goods stores such as Academy Sports and Bass Pro Shops have started carrying an impressive array of firearms.



In contrast to tacky Hawaiian souvenirs, the quality of Kamaka ukuleles makes them a favorite of ukulele phenom Jake Shimabukuro and others who are willing to pay \$1,000 or more for a high-end instrument.

[Wikimedia Commons](#) – public domain.

Finally, damaging attacks may come not only from larger firms but also from smaller ones that adopt an even narrower focus. A sporting goods store that sells camping, hiking, kayaking, and skiing goods, for example, might lose business to a store that focuses solely on ski apparel because the latter can provide more guidance about how skiers can stay warm and avoid broken bones.

Strategy at the Movies

Zoolander

One man's trash is another man's fashion? That's what fashion mogul Jacobim Mugatu was counting on in the 2001 comedy *Zoolander*. In his continued effort to be the most cutting-edge designer in the fashion industry, Mugatu developed a new line of clothing inspired "by the streetwalkers and hobos that surround us." His new product line, Derelict, characterized by dresses made of burlap and parking cones and pants made of garbage

bags and tin cans, was developed for customers who valued the uniqueness of his...eclectic design. Emphasizing unique products is typical of a company following a differentiation strategy; however, Mugatu targeted a very specific set of customers. Few people would probably be enticed to wear garbage for the sake of fashion. By catering to a niche target market, Mugatu went from a simple differentiation strategy to a focused differentiation. Mugatu's Derelict campaign in *Zoolander* is one illustration of how a particular firm might develop a focused differentiation strategy.

Key Takeaway

- Focus strategies can be effective business-level strategies to the extent that a firm can match their goods and services to specific niche markets.

Exercises

1. What are three different demographics that firms might target to establish a focus strategy?
2. What is an example of a business that you think is focused in too narrow a fashion to be successful? How might it change to be more successful?

References

Cat's Ass Coffee, href="http://www.catsasscoffee.com/order3.html">http://www.catsasscoffee.com/order3.html.

Onishi, N. 2010, April 17. From dung to coffee brew with no aftertaste. *New York Times*. Retrieved from <http://www.nytimes.com/2010/04/18/world/asia/18civetcoffee.html?pagewanted=all>.

Porter, M. E. 1980. *Competitive strategy: Techniques for analyzing industries and competitors*. New York, NY: Free Press.

Short, J. C. 2007. A touch of the masters' hands: An interview with Augustino and Donna Loprinzi. *Journal of Applied Management and Entrepreneurship*, 12, 103–109.

5.6 Best-Cost Strategy

Learning Objectives

1. Describe the nature of a best-cost strategy.
2. Understand why executing a best-cost strategy is difficult.

Table 5.9 Best-Cost Strategy

Firms that charge relatively low prices and offer substantial differentiation are following a best-cost strategy. This strategy is difficult to execute, but it is also potentially very rewarding. Several examples of firms pursuing a best-cost strategy are illustrated below.

<p>Southwest Airlines provides low cost flights to vacations destinations such as San Antonio, San Diego, and Orland. While many airlines make passengers feel like cattle loaded on to a truck, Southwest creates fun by, for example, getting children excited about visiting Sea World when they see this custom Shamu plane design.</p>	<p>Chipotle Mexican Grill relies on organic ingredients to create very tasty burritos that are sold at prices comparable to those of fast-food restaurants. When noon arrives, many hungry people prefer to spend their lunch dollars on a top-shelf burrito rather than a greasy burger combo meal.</p>
<p>Target offers extremely competitive prices, but the firm also differentiates itself from other discount retailers by carrying products from trendy designers such as Michael Graves, Isaac Mizrahi, Fiorrucci, and Liza Lange.</p>	<p>Pabst Blue Ribbon is offered at an extremely low price and its taste (or lack thereof) is comparable that to other inexpensive beers. “PBR” enjoys brand loyalty, however, due to its high name recognition. The frequent appearance of PBR’s well-known logo on signs, T-shirts, and other merchandise has helped make PBR an enduring favorite among beer consumers with light wallets.</p>

The Challenge of Following a Best-Cost Strategy

Some executives are not content to have their firms compete based on offering low prices or unique features. They want it all! Firms that charge relatively low prices *and* offer substantial differentiation are following a **best-cost** strategy (Table 5.9 “Best-Cost Strategy”). This strategy is difficult to execute in part because creating unique features and communicating to customers why these features are useful generally raises a firm’s costs of doing business. Product development and advertising can both be quite expensive. However, firms that manage to implement an effective best-cost strategy are often very successful.

Target appears to be following a best-cost strategy. The firm charges prices that are relatively low among retailers while at the same time attracting trend-conscious consumers by carrying products from famous designers, such as

Michael Graves, Isaac Mizrahi, Fiorucci, Liz Lange, and others. This is a lucrative position for Target, but the position is under attack from all sides. Cost leader Walmart charges lower prices than Target. This makes Walmart a constant threat to steal the thriftiest of Target's customers. Focus differentiators such as Anthropologie that specialize in trendy clothing and home furnishings can take business from Target in those areas. Deep discounters such as T.J. Maxx and Marshalls offer another viable alternative to shoppers because they offer designer clothes and furnishings at closeout prices. A firm such as Target that uses a best-cost strategy also opens itself up to a wider variety of potentially lethal rivals.

Developing a Best-Cost Strategy at Plain Ivey Jane

According to government statistics, women are 60 percent less likely than men to become entrepreneurs. Meanwhile, succeeding within the specialty fashion retailing market is notoriously difficult. These trends do not worry Sarah Reeves, a young entrepreneur and 2007 graduate of Auburn University who is rapidly becoming a key player within the Austin, Texas, retail scene by offering high-end fashion at low prices.

On her website (<http://www.plainiveyjane.com>), Sarah describes Plain Ivey Jane as “the go-to place for women who want to elevate their wardrobes. We offer high end designer names at a discount, and the new overstocked apparel is handpicked from over 70 different brands to offer exactly what Austin needs at a price every girl can afford. To pair with your fabulous new wardrobe, Plain Ivey Jane carries accessories from undiscovered local artisans.” We asked Reeves to discuss her firm (Ketchen & Short).

Question:

Can you tell us a little about your Plain Ivey Jane concept?

Sarah Reeves, Owner:

Plain Ivey Jane sells overstock from Anthropologie, Urban Outfitters, Bloomingdales, and other high-end and small designers. Although I buy from the same designers as the big and famous retailers, our dresses and accessories are sold at a fraction of their prices.

Question:

What differentiates your boutique from competitors?

Reeves:

I'm one of the lowest-priced retailers in the shopping district that people in Austin call the Second Street area. My niche in the fashion retailing business is that my merchandise is overstock from great brands. There's maybe one other business in Austin that sells overstock. What makes my concept different is that it has the feel of a high-end retail store versus a basement feel of the typical discount retailer.

Question:

Do you have a lot of regular customers?

Reeves:

Yes. Once people find out what I offer, they're in here all the time. I see the same group of people every few months, but getting in new faces is the challenge. I think a lot of people walk by and assume that our clothes are expensive, but nothing could be further from the truth.

Question:

Were you fearful of starting your own business so young?

Reeves:

No, I figured this was a great time since I had nothing to lose. I thought getting it out of my system now was a good idea, and it was a good time since I was able to get a great deal on my lease. With the downturn in the economy, the time was right for my lower-priced strategy.

Question:

What would you say is the biggest key to success for small business?

Reeves:

Flexibility. Rolling with the punches and definitely the ability to follow up with people. I thought that people who owned their own business must know what they are doing, but many people don't. At this point, I prefer to do everything myself. At least I can blame myself when things go wrong.

Another key is networking with other small-business owners. A lot of the other boutique owners nearby have become close friends. I learn what works for them and what might possibly apply to my concept.



The success that 2007 college graduate Sarah Reeves has enjoyed with Plain Ivey Jane may inspire other young women to become entrepreneurs.

Nit Ng – [Clothes Store](#) – CC BY-NC-ND 2.0.

Table 5.10 Driving toward a Best-Cost Strategy by Reducing Overhead

Many firms would like to use a best cost strategy but struggle to meet the strategy's dual requirements of charging low prices and providing differentiation features. One way to help make best cost a reality is to use a business model that slashes fixed costs. Amazon.com, for example, can charge low prices in part because it does not have to absorb the overhead involved in operating

stores. Similarly, some talented chefs are pursuing a best cost strategy by operating food trucks and thereby avoiding the overhead required to run a restaurant such as rent and utilities. SEveral examples are illustrated below.

<p>For about the same price as a Subway or Jimmy John’s sandwich, Counter Culture in Austin, Texas, provides vegan offerings such as their Garbonzo “Tuna” sandwich.</p>	<p>Owners Kahala and Kat founded Ninja Plate Lunch in Portland, Oregon, to offer large portions of delectable Hawaiian foods cub as pulled pork for only around \$5.</p>
<p>PBJ’s offer unique sandwiches with organic peanut butter at the heart of many of their creations. The traditional PB and J is a staple nationwide, but customers will travel far to get the “Hot Hood” with Challah bread, black cherry jam, jalapeño, apple wood-somked bacon, and PBJ’s peanut butter for only \$5.50.</p>	<p>In the smash hit graphic novel <i>Tales of Garcón: The Franchise Players</i>, the Tapas Taxi takes the concept of a cheap taxi ride to a new level by also offering passengers a variety of “tapas.” These Spanish snacks are top shelf, of course!</p>

Pursuing the Best-Cost Strategy through a Low-Overhead Business Model

One route toward a best-cost strategy is for a firm to adopt a business model whose fixed costs and overhead are very low relative to the costs that competitors are absorbing (Table 5.10 “Driving toward a Best-Cost Strategy by Reducing Overhead”). The Internet has helped make this possible for some firms. Amazon, for example, can charge low prices in part because it does not have to endure the expenses that firms such as Walmart and Target do in operating many hundreds of stores. Meanwhile, Amazon offers an unmatched variety of goods. This combination has made Amazon the unquestioned leader in e-commerce.

Another example is Netflix. This firm is able to offer customers a far greater variety of movies and charge lower prices than video rental stores by conducting all its business over the Internet and via mail. Netflix’s best-cost strategy has been so successful that \$10,000 invested in the firm’s stock in May 2006 was worth more than \$90,000 five years later.¹



Hey Cupcake! in Austin, Texas, is a low-overhead bakery that has become a delicious success.

Evan Bench – [Hey Cupcake!](#) – CC BY 2.0.

Moving toward a best-cost strategy by dramatically reducing expenses is also possible for firms that cannot rely on the Internet as a sales channel. Owning a restaurant requires significant overhead costs, such as rent and utilities. Some talented chefs are escaping these costs by taking their food to the streets. Food trucks that serve high-end specialty dishes at very economical prices are becoming a popular trend in cities around the country. In Portland, Oregon, a food truck called the Ninja Plate Lunch offers large portions of delectable Hawaiian foods such as pulled pork for around \$5. Another Portland food truck is PBJ's, whose unique and inexpensive sandwiches often center on organic peanut butter. Beyond keeping costs low, the mobility of food trucks offers important advantages over a traditional restaurant. Some food trucks set up outside big-city nightclubs, for example, to sell partygoers a late-night snack before they head home.

Key Takeaway

- A best-cost strategy can be an effective business-level strategy to the extent that a firm offers differentiated goods and services at relatively low prices.

Exercises

1. What is an example of an industry that you think a best-cost strategy could be successful? How would you differentiate a company to achieve success in this industry?
2. What is an example of a firm following a best-cost strategy near your college or university?

¹Statistics drawn from Standard & Poor's stock report on Netflix.

References

Ketchen, D. J., & Short, J. C. Forthcoming. The discount diva: An interview with Sarah Reeves. *Journal of Applied Management and Entrepreneurship*.

5.7 Stuck in the Middle

Learning Objectives

1. Describe the problem of being stuck in the middle of different generic strategies.
2. Understand why trying to please everyone often creates problems when crafting a business-level strategy.

Table 5.11 Stuck in the Middle

A firm is said to be stuck in the middle if it does not offer features that are unique enough to convince customers to buy its offerings and its prices are too high to effectively compete on based on price. Firms that are stuck in the middle generally perform poorly because they lack a clear market or competitive pricing. Several examples of such firms are illustrated below.

<p>Arby's signature roast beef sandwiches are neither cheaper than other fast food nor are they standouts in taste. Perhaps not surprisingly, parent company Wendy's has been trying to sell Arby's.</p>	<p>Electronics retailer Circuit City found itself squeezed by the superior service offer by rival Best Buy and the cheaper prices charged on electronics by Walmart and Target. The firm went bankrupt in 2009 after sixty years in business.</p>
<p>Sears and their famous catalog once dominated U.S. retailing, but the failure to cultivate customers among newer generations and prices that are higher than those of rivals have severely wounded the company.</p>	<p>Kmart's "Blue Light Specials" that alert shoppers to a deeply discounted item reflect the firm's long-running effort to be a cost leader. But emerging on the losing end of a price war with Walmart sent the firm into bankruptcy. Although Kmart escaped bankruptcy, it may be a matter of time until the lights go out permanently for Kmart.</p>

Stuck in the Middle: Neither Inexpensive nor Differentiated

Some firms fail to effectively pursue one of the generic strategies. A firm is said to be **stuck in the middle** if it does not offer features that are unique enough to convince customers to buy its offerings, and its prices are too high to compete effectively based on price (Table 5.11 "Stuck in the Middle"). Arby's appears to be a good example. Arby's signature roast beef sandwiches are neither cheaper than other fast-food sandwiches nor standouts in taste. Firms that are stuck in the middle generally perform poorly because they lack a clear market or competitive pricing. Perhaps not surprisingly, parent company Wendy's has been trying to sell Arby's despite having recently acquired the company in 2008. Stockholders apparently agreed with the plan to cut Arby's loose—the price of Wendy's stock rose 7 percent the day the plan was announced (McWilliams, 2011).

Doing Everything Means Doing Nothing Well

Michael Porter has noted that strategy is as much about executives deciding what a firm *is not* going to do as it is about deciding what the firm *is* going to do (Porter, 1996). In other words, a firm's business-level strategy should not involve trying to serve the varied needs of different segment of customers in an industry. No firm could possibly pull this off.



This illustration from 1887 captures the lesson of Aesop's fable "The Miller, His Son, and Their Ass"—a lesson that executives need to follow.

[Wikimedia Commons](#) – public domain.

The fable "The Miller, His Son, and Their Ass" told by the ancient Greek storyteller Aesop helps illustrate this idea. In this tale, a miller and his son were driving their ass (donkey) to market for sale. They soon encountered a group of girls who mocked them for walking instead of riding. The father then told his son to ride the animal. Not long after, father and son overheard a man claim that young people had no respect for the elderly. On hearing this opinion, the father told the boy to dismount the animal and he began to ride. They progressed a short distance farther and met a company of women and children. Several of the women suggested that it was both ridiculous and lazy for the father to ride while the young son was forced to walk alone; once again the two changed positions. Another bystander suggested that they could not believe that the man was the owner of the beast, judging from the way it was weighted down. In fact, it would make more sense for the man and his son to carry the ass. On hearing this, the father and his son tied the

animal's legs together and carried it on a pole. As they crossed a bridge near town, the townspeople began to gather and laugh at the unorthodox sight. The noise and the chaos frightened the beast, leading it to thrash around until it tumbled into the river. With tongue in cheek, we note that the moral of the story is that if you try to please everyone, you may lose your ass (Short & Ketchen, 2005).

Getting Outmaneuvered by Competitors

In many cases, firms become stuck in the middle not because executives fail to arrive at a well-defined strategy but because firms are simply outmaneuvered by their rivals. After six decades as an electronics retailer, Circuit City went out of business in 2009. The firm had simply lost its appeal to customers. Rival electronics retailer Best Buy offered comparable prices to Circuit City's prices, but the former offered much better customer service. Meanwhile, the service offered by discount retailers such as Walmart and Target on electronics were no better than Circuit City's, but their prices were better.

The results were predictable—customers who made electronics purchases based on the service they received went to Best Buy, and value-driven buyers patronized Walmart and Target. Circuit City's demise was probably inevitable because it lacked a competitive advantage within the electronics business. Although Target was on the winning end of this battle, Target executives need to worry that their firm could become stuck in the middle between Walmart's better prices on one side and the trendiness of specialty shops on the other.

IBM's personal computer business offers another example. IBM tried to position its personal computers via a differentiation strategy. In particular, IBM's personal computers were offered at high prices, and the firm promised to offer excellent service to customers in return. Unfortunately for IBM, rivals such as Dell were able to provide equal levels of service while selling computers at lower prices. Nothing made IBM's computers stand out from the crowd, and the firm eventually exited the business.

At its peak in the mid-2000s, Movie Gallery operated approximately 4,700 video rental stores. By 2010, the firm was dead. This rapid demise can be traced to the firm becoming outmaneuvered by Netflix. When Netflix began offering inexpensive DVD rentals through the mail, customers defected in droves from Movie Gallery and other video rental stores such as Blockbuster. Netflix customers were delighted by the firm's low prices, vast selection, and the convenience of not having to visit a store to select and return videos. Movie Gallery was stuck in the middle—its prices were higher than those of Netflix, and Netflix's service was superior. Once individuals lacked a compelling reason to be Movie Gallery customers, the firm's fate was sealed.



Netflix and Redbox have left video rental stores such as Movie Gallery and Blockbuster stuck in the middle. Blockbuster filed for bankruptcy in late 2010.

[Wikimedia Commons](#) – CC BY-SA 3.0.

Key Takeaway

- When executing a business-level strategy, a firm must not become stuck in the middle between viable generic business-level strategies by neither offering unique features nor competitive pricing.

Exercises

1. What is an example of a firm that you would consider to be “stuck in the middle”? What would your advice be to the executives in charge of this firm?
2. Research a company that has gone bankrupt or otherwise stopped operations in the past decade because their strategy was “stuck in the middle” of otherwise viable generic business-level strategies. Could its demise have been prevented?

References

McWilliams, J. 2011, January 21. Wendy's/Arby's to try to sell Arby's. *Atlantic Journal-Constitution*. Retrieved from <http://www.ajc.com/business/wendys-arbys-to-try-810320.html>.

Porter, M. E. 1996. What is strategy? *Harvard Business Review*, reprint 96608.

Short, J. C., & Ketchen, D. J. 2005. Using classic literature to teach timeless truths: An illustration using Aesop's fables to teach strategic management. *Journal of Management Education*, 29(6), 816–832.

5.8 Conclusion

This chapter explains generic business-level strategies that executives select to keep their firms competitive. Executives must select their firm's source of competitive advantage by choosing to compete based on low-cost versus more expensive features that differentiate their firm from competitors. In addition, targeting either a narrow or broad market helps firms further understand their customer base. Based on these choices, firms will follow cost leadership, differentiation, focused cost leadership, or focused differentiation strategies. Another potentially viable business strategy, best cost, exists when firms offer relatively low prices while still managing to differentiate their goods or services on some important value-added aspects. All firms can fall victim to being "stuck in the middle" by not offering unique features or competitive prices.

Exercises

1. Divide your class into four or eight groups, depending on the size of the class. Each group should select a different industry. Find examples of each generic business-level strategy for your industry. Discuss which strategy seems to be the most successful in your selected industry.
2. This chapter discussed Target and other retailers. If you were assigned to turn around a struggling retailer such as Kmart, what actions would you take to revive the company?

Chapter 6: Supporting the Business-Level Strategy: Competitive and Cooperative Moves

Chapter 6: Supporting the Business-Level Strategy: Competitive and Cooperative Moves

6.1 Supporting the Business-Level Strategy: Competitive and Cooperative Moves

6.2 Making Competitive Moves

6.3 Responding to Competitors' Moves

6.4 Making Cooperative Moves

6.5 Conclusion

6.1 Supporting the Business-Level Strategy: Competitive and Cooperative Moves

Learning Objectives

After reading this chapter, you should be able to understand and articulate answers to the following questions:

1. What different competitive moves are commonly used by firms?
2. When and how do firms respond to the competitive actions taken by their rivals?
3. What moves can firms make to cooperate with other firms and create mutual benefits?

Can Merck Stay Healthy?



The financial stakes are high for Merck and its rivals in the pharmaceutical industry.

[Wikimedia Commons](#) – public domain.

On June 7, 2011, pharmaceutical giant Merck & Company Inc. announced the formation of a strategic alliance with Roche Holding AG, a smaller pharmaceutical firm that is known for excellence in medical testing. The firms

planned to work together to create tests that could identify cancer patients who might benefit from cancer drugs that Merck had under development (Stynes, 2011).

This was the second alliance formed between the companies in less than a month. On May 16, 2011, the US Food and Drug Administration approved a drug called Victrelis that Merck had developed to treat hepatitis C. Merck and Roche agreed to promote Victrelis together. This surprised industry experts because Merck and Roche had offered competing treatments for hepatitis C in the past. The Merck/Roche alliance was expected to help Victrelis compete for market share with a new treatment called Incivek that was developed by a team of two other pharmaceutical firms: Vertex and Johnson & Johnson.

Experts predicted that Victrelis's wholesale price of \$1,100 for a week's supply could create \$1 billion of annual revenue. This could be an important financial boost to Merck, although the company was already enormous. Merck's total of \$46 billion in sales in 2010 included approximately \$5.0 billion in revenues from asthma treatment Singulair, \$3.3 billion for two closely related diabetes drugs, \$2.1 billion for two closely related blood pressure drugs, and \$1.1 billion for an HIV/AIDS treatment.

Despite these impressive numbers, concerns about Merck had reduced the price of the firm's stock from nearly \$60 per share at the start of 2008 to about \$36 per share by June 2011. A big challenge for Merck is that once the patent on a drug expires, its profits related to that drug plummet because generic drugmakers can start selling the drug. The patent on Singulair is set to expire in the summer of 2012, for example, and a sharp decline in the massive revenues that Singulair brings into Merck seemed inevitable.¹

A major step in the growth of Merck was the 2009 acquisition of drugmaker Schering-Plough. By 2011, Merck ranked fifty-third on the *Fortune* 500 list of America's largest companies. Rivals Pfizer (thirty-first) and Johnson & Johnson (fortieth) still remained much bigger than Merck, however. Important questions also loomed large. Would the competitive and cooperative moves made by Merck's executives keep the firm healthy? Or would expiring patents, fearsome rivals, and other challenges undermine Merck's vitality?

Friedrich Jacob Merck had no idea that he was setting the stage for such immense stakes when he took the first steps toward the creation of Merck. He purchased a humble pharmacy in Darmstadt, Germany, in 1688. In 1827, the venture moved into the creation of drugs when Heinrich Emanuel Merck, a descendant of Friedrich, created a factory in Darmstadt in 1827. The modern version of Merck was incorporated in 1891. More than three hundred years after its beginnings, Merck now has approximately ninety-four thousand employees.



Merck's origins can be traced back more than three centuries to Friedrich Jacob Merck's purchase of this pharmacy in 1688.

[Wikimedia Commons](#) – public domain.

For executives leading firms such as Merck, selecting a generic strategy is a key aspect of business-level strategy, but other choices are very important too. In their ongoing battle to make their firms more successful, executives must make decisions about what competitive moves to make, how to respond to rivals' competitive moves, and what cooperative moves to make. This chapter discusses some of the more powerful and interesting

options. As our opening vignette on Merck illustrates, often another company, such as Roche, will be a potential ally in some instances and a potential rival in others.

¹Statistics drawn from Standard & Poor's stock report on Merck.

References

Stynes, T. 2011, June 7. Merck, Roche focus on tests for cancer treatments. *Wall Street Journal*. Retrieved from online.wsj.com/article/SB10001424052702304432304576371491785709756.html?mod=googlenews_wsj.

6.2 Making Competitive Moves

Figure 6.1 Making Competitive Moves

The study of competitive moves draws from military history, including Sun Tzu's classic book The Art of War. Like a skilled samurai, wise business strategists are familiar with a number of competitive moves that may help guide their firms to victory.

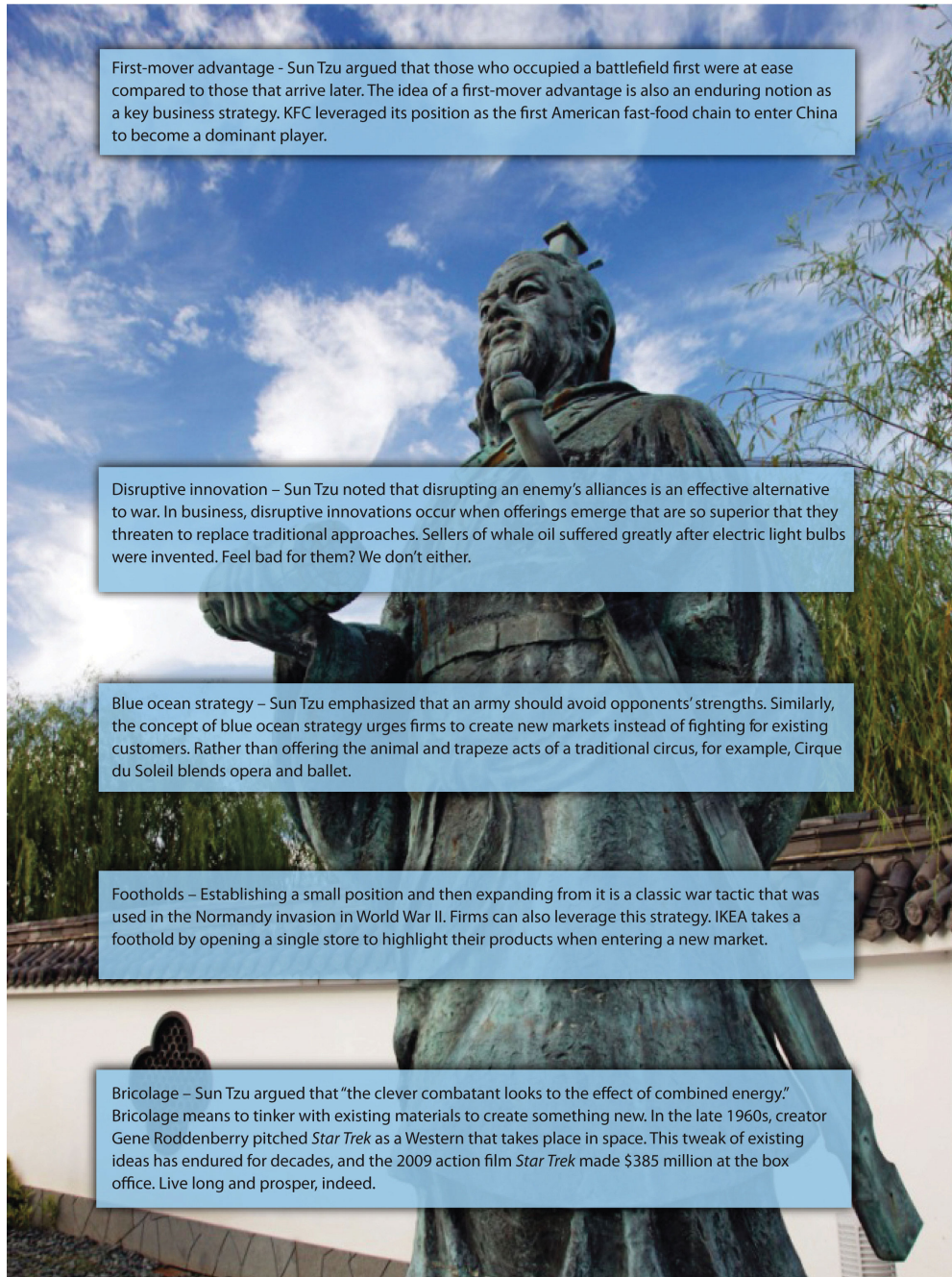

Wikimedia Commons – CC BY-SA 3.0.

Learning Objectives

1. Understand the advantages and disadvantages of being a first mover.
2. Know how disruptive innovations can change industries.
3. Describe two ways that using foothold can benefit firms.
4. Explain how firms can win without fighting using a blue ocean strategy.
5. Describe the creative process of bricolage.

Being a First Mover: Advantages and Disadvantages

Table 6.2 First Mover Advantage

When confronted by a poisonous snake, should you strike first or wait for the serpent to make a move? Each option has advantages and disadvantages. In business, being a first mover might allow a firm to “rattle its rivals, but a first move might also attract the “venom” of skeptical customers. Below we offer examples of successful—and not so successful—first movers.

First Move Successes	First Move Failures
Kosmo.com provided free delivery of a host of goods such as games, magazines, DVDs, and Starbucks coffee. While their first mover advantage allowed them to gain popularity during the dot.com boom, the company lasted only four years.	
At a time when using most personal computers required memorizing obscure commands, Apple pioneered a user-friendly interface. The firm gained a reputation as an innovator that persists today.	Netscape’s web browser was a first mover that was popular in the 1990s, but nearly extinct by 2002 with the advent of Microsoft’s competitive offering—Internet Explorer.
Following World War II, Japan’s economy laid in ruin. Ibuka Masaru used this backdrop to build a company that would be the first in Japan to create tape recorders and transistors radios. The company he pioneered—Sony—has now been a fierce electronics competitor for over a half century.	Not all of Apple’s first moves are triumphs. The firm’s disastrous attempt to pioneer the personal digital assistant market through its “Newton” created a loss of around one-hundred million dollars.

A famous cliché contends that “the early bird gets the worm.” Applied to the business world, the cliché suggests that certain benefits are available to a **first mover** into a market that will not be available to later entrants (Figure 6.1 “Making Competitive Moves”). A **first-mover advantage** exists when making the initial move into a market allows a firm to establish a dominant position that other firms struggle to overcome (Table 6.2 “First Mover Advantage”). For example, Apple’s creation of a user-friendly, small computer in the early 1980s helped fuel a reputation for creativity and innovation that persists today. Kentucky Fried Chicken (KFC) was able to develop a strong bond with Chinese

officials by being the first Western restaurant chain to enter China. Today, KFC is the leading Western fast-food chain in this rapidly growing market. Genentech's early development of biotechnology allowed it to overcome many of the pharmaceutical industry's traditional entry barriers (such as financial capital and distribution networks) and become a profitable firm. Decisions to be first movers helped all three firms to be successful in their respective industries (Ketchen, et. al., 2004).

On the other hand, a first mover cannot be sure that customers will embrace its offering, making a first move inherently risky. Apple's attempt to pioneer the personal digital assistant market, through its Newton, was a financial disaster. The first mover also bears the costs of developing the product and educating customers. Others may learn from the first mover's successes and failures, allowing them to cheaply copy or improve the product. In creating the Palm Pilot, for example, 3Com was able to build on Apple's earlier mistakes. Matsushita often refines consumer electronic products, such as compact disc players and projection televisions, after Sony or another first mover establishes demand. In many industries, knowledge diffusion and public-information requirements make such imitation increasingly easy.

One caution is that first movers must be willing to commit sufficient resources to follow through on their pioneering efforts. RCA and Westinghouse were the first firms to develop active-matrix LCD display technology, but their executives did not provide the resources needed to sustain the products spawned by this technology. Today, these firms are not even players in this important business segment that supplies screens for notebook computers, camcorders, medical instruments, and many other products.

To date, the evidence is mixed regarding whether being a first mover leads to success. One research study of 1,226 businesses over a fifty-five-year period found that first movers typically enjoy an advantage over rivals for about a decade, but other studies have suggested that first moving offers little or no advantages.

Perhaps the best question that executives can ask themselves when deciding whether to be a first mover is, how likely is this move to provide my firm with a sustainable competitive advantage? First moves that build on strategic resources such as patented technology are difficult for rivals to imitate and thus are likely to succeed. For example, Pfizer enjoyed a monopoly in the erectile dysfunction market for five years with its patented drug Viagra before two rival products (Cialis and Levitra) were developed by other pharmaceutical firms. Despite facing stiff competition, Viagra continues to raise about \$1.9 billion in sales for Pfizer annually.¹

In contrast, E-Trade Group's creation in 2003 of the portable mortgage seemed doomed to fail because it did not leverage strategic resources. This innovation allowed customers to keep an existing mortgage when they move to a new home. Bigger banks could easily copy the portable mortgage if it gained customer acceptance, undermining E-Trade's ability to profit from its first move.

Disruptive Innovation

Some firms have the opportunity to shake up their industry by introducing a **disruptive innovation**—an innovation that conflicts with, and threatens to replace, traditional approaches to competing within an industry (Table 6.3 “Shaking the Market with Disruptive Innovations”). The iPad has proved to be a disruptive innovation since its introduction by Apple in 2010. Many individuals quickly abandoned clunky laptop computers in favor of the sleek tablet format offered by the iPad. And as a first mover, Apple was able to claim a large share of the market.

Table 6.3 Shaking the Market with Disruptive Innovations

Disruptive innovations occur when firms introduce offerings that are so unique and superior that they threaten to replace traditional approaches. We illustrate a number of disruptive innovations below.

Tablet computers have the potential to disrupt laptop sales due to their versatility and portability. Reading books can be awkward on traditional computers, but user-friendly devices such as iPad, Nook, and Kindle are popular platforms for aggressive textbook publishers.

Many stores that relied on compact disc sales went under when downloadable digital media disrupted the music industry. Years earlier, CDs supplanted vinyl albums and cassette tapes due to their superior durability and quality. Will the cycle continue with a new technology replacing downloads?

Digital cameras disrupted the photography industry by offering instant gratification and eliminating the cost of getting film developed.

The emergence of personal computers disrupted the dominance of mainframes and made it possible for everyone to have a computer in their home.

Steamships replaced sailing ships, which must have been a relief to the prisoners who were often required to row when there was no wind.

The iPad story is unusual, however. Most disruptive innovations are not overnight sensations. Typically, a small group of customers embrace a disruptive innovation as early adopters and then a critical mass of customers builds over time. An example is digital cameras. Few photographers embraced digital cameras initially because they took pictures slowly and offered poor picture quality relative to traditional film cameras. As digital cameras have improved, however, they have gradually won over almost everyone that takes pictures. Executives who are deciding whether to pursue a disruptive innovation must first make sure that their firm can sustain itself during an initial period of slow growth.

Footholds

Table 6.4 Footholds

Footholds are useful for rock climbers looking for sure footing to ascend a difficult mountain, as well as firms hoping to gain positions in new markets. In business, a foothold is a small position that a firm intentionally establishes within a market in which it does not yet compete. Examples of the use of footholds are illustrated below.

Swedish furniture seller IKEA opens just a single store when entering a new country, such as their first store in Japan shown here. This foothold is used as a showcase to establish IKEA's brand; then more stores are opened once brand recognition is gained in the country.

Pharmaceutical giant Merck obtained a foothold by purchasing SmartCells Inc.,—a company developing a possible new diabetes treatment.

The foothold concept also applies to warfare. Many armies establish new positions in geographic territories that they have not previously occupied. The Allied Forces used Normandy, France, as their foothold to advance on German forces during World War II.

In warfare, many armies establish small positions in geographic territories that they have not occupied previously. These

footholds provide value in at least two ways (Table 6.4 “Footholds”). First, owning a foothold can dissuade other armies from attacking in the region. Second, owning a foothold gives an army a quick strike capability in a territory if the army needs to expand its reach.

Similarly, some organizations find it valuable to establish footholds in certain markets. Within the context of business, a **foothold** is a small position that a firm intentionally establishes within a market in which it does not yet compete (Upson, et. al.). Swedish furniture seller IKEA is a firm that relies on footholds. When IKEA enters a new country, it opens just one store. This store is then used as a showcase to establish IKEA’s brand. Once IKEA gains brand recognition in a country, more stores are established (Hambrick & Fredrickson, 2005).

Pharmaceutical giants such as Merck often obtain footholds in emerging areas of medicine. In December 2010, for example, Merck purchased SmartCells Inc., a company that was developing a possible new treatment for diabetes. In May 2011, Merck acquired an equity stake in BeiGene Ltd., a Chinese firm that was developing novel cancer treatments and detection methods. Competitive moves such as these offer Merck relatively low-cost platforms from which it can expand if clinical studies reveal that the treatments are effective.

Blue Ocean Strategy

It is best to win without fighting.

Sun-Tzu, *The Art of War*

A **blue ocean strategy** involves creating a new, untapped market rather than competing with rivals in an existing market (Kim, 2004). This strategy follows the approach recommended by the ancient master of strategy Sun-Tzu in the quote above. Instead of trying to outmaneuver its competition, a firm using a blue ocean strategy tries to make the competition irrelevant (Table 6.5 “Blue Ocean Strategy”). Baseball legend Wee Willie Keeler offered a similar idea when asked how to become a better hitter: “Hit ‘em where they ain’t.” In other words, hit the baseball where there are no fielders rather than trying to overwhelm the fielders with a ball hit directly at them.

Nintendo openly acknowledges following a blue ocean strategy in its efforts to invent new markets. In 2006, Perrin Kaplan, Nintendo’s vice president of marketing and corporate affairs for Nintendo of America noted in an interview, “We’re making games that are expanding our base of consumers in Japan and America. Yes, those who’ve always played games are still playing, but we’ve got people who’ve never played to start loving it with titles like *Nintendogs*, *Animal Crossing* and *Brain Games*. These games are blue ocean in action (Rosmarin, 2006).” Other examples of companies creating new markets include FedEx’s invention of the fast-shipping business and eBay’s invention of online auctions.

Table 6.5 Blue Ocean Strategy

It’s a big ocean out there! When pursuing a blue ocean strategy, executives try to create and exploit vast untapped markets rather than competing directly with rivals. We provide several examples of firms following a blue ocean strategy below.

The interactive features of Nintendo's Wii transformed playing video games from a hobby for the hardcore gamers into a treasured family event.

Coffee shops were once the domain of old men, insomniacs, and chain-smoking urban hipsters. By reinventing coffee shops, Starbucks made the \$4 latte a must-have item for college students, businesspeople, and soccer moms.

At a time when cars were only for the wealthy, Henry Ford envisioned cars that were affordable to the typical American. Ford priced his vehicles so that his assembly line workers could afford them.

eBay's invention of online auctions extended the auction experience—and the chance to buy that rare Elvis plate—to anyone with Internet access.

Golf can be frustrating to even skilled players. Callaway's creation of the Big Bertha club with an over-sized head made golf appealing to a whole new set of weekend warriors.

A classy, affordable wine for novice wine drinkers? Casella wines (maker of Yellow Tail) steered clear of wine snobs and sommeliers and instead created fun and simple tastes for the masses.

Bricolage

Bricolage is a concept that is borrowed from the arts and that, like blue ocean strategy, stresses moves that create new markets. Bricolage means using whatever materials and resources happen to be available as the inputs into a creative process. A good example is offered by one of the greatest inventions in the history of civilization: the printing press. As noted in the *Wall Street Journal*, "The printing press is a classic combinatorial innovation. Each of its key elements—the movable type, the ink, the paper and the press itself—had been developed separately well before Johannes Gutenberg printed his first Bible in the 15th century. Movable type, for instance, had been independently conceived by a Chinese blacksmith named Pi Sheng four centuries earlier. The press itself was adapted from a screw press that was being used in Germany for the mass production of wine (Johnson)." Gutenberg took materials that others had created and used them in a unique and productive way.



Actor Johnny Depp uses bricolage when creating a character. Captain Jack Sparrow, for example, combines aspects of Rolling Stones guitarist Keith Richards and cartoon skunk Pepé Le Pew.

Executives apply the concept of bricolage when they combine ideas from existing businesses to create a new business. Think miniature golf is boring? Not when you play at one of Monster Mini Golf's more than twenty-five locations. This company couples a miniature golf course with the thrills of a haunted house. In April 2011, Monster Mini Golf announced plans to partner with the rock band KISS to create a "custom-designed, frightfully fun course [that] will feature animated KISS and monster props lurking in all 18 fairways" in Las Vegas (Monster Mini Golf, 2011).



Braveheart meets heavy metal when TURISAS takes the stage.

[Wikimedia Commons](#) – CC BY-SZ 3.0.

Many an expectant mother has lamented the unflattering nature of maternity clothes and the boring stores that sell them. Coming to the rescue is Belly Couture, a boutique in Lubbock, Texas, that combines stylish fashion and maternity clothes. The store’s clever slogan—“Motherhood is haute”—reflects the unique niche it fills through bricolage. A wilder example is TURISAS, a Finnish rock band that has created a niche for itself by combining heavy metal music with the imagery and costumes of Vikings. The band’s website describes their effort at bricolage as “inspirational cinematic battle metal brilliance (Turisas).” No one ever claimed that rock musicians are humble.

Strategy at the Movies

Love and Other Drugs

Competitive moves are chosen within executive suites, but they are implemented by frontline employees. Organizational success thus depends just as much on workers such as salespeople excelling in their roles as it does on executives’ ability to master strategy. A good illustration is provided in the 2010 film *Love and Other Drugs*, which was based on the nonfiction book *Hard Sell: The Evolution of a Viagra Salesman*.

As a new sales representative for drug giant Pfizer, Jamie Randall believed that the best way to increase sales of Pfizer’s antidepressant Zoloft in his territory was to convince highly respected physician Dr. Knight to prescribe Zoloft rather than the good doctor’s existing preference, Ely Lilly’s drug Prozac. Once Dr. Knight began prescribing Zoloft, thought Randall, many other physicians in the area would follow suit.

This straightforward plan proved more difficult to execute than Randall suspected. Sales reps from Ely Lilly and other pharmaceutical firms aggressively pushed their firm’s products, such as by providing all-expenses-paid

trips to Hawaii for nurses in Dr. Knight's office. Prozac salesman Trey Hannigan went so far as to beat up Randall after finding out that Randall had stolen and destroyed Prozac samples. While assault is an extreme measure to defend a sales territory, the actions of Hannigan and the other salespeople depicted in *Love and Other Drugs* reflect the challenges that frontline employees face when implementing executives' strategic decisions about competitive moves.



Marco – [love_and_other_drugs](#) – CC BY 2.0.

Key Takeaway

- Firms can take advantage of a number of competitive moves to shake up or otherwise get ahead in an ever-changing business environment.

Exercises

1. Find a key trend from the general environment and develop a blue ocean strategy that might capitalize on that trend.
2. Provide an example of a product that, if invented, would work as a disruptive innovation. How widespread would be the appeal of this product?
3. How would you propose to develop a new foothold if your goal was to compete in the fashion industry?

4. Develop a new good or service applying the concept of bricolage. In other words, select two existing businesses and describe the experience that would be created by combining those two businesses.

¹Figures from Standard & Poor's stock report on Pfizer.

References

Hambrick, D. C., & Fredrickson, J. W. 2005. Are you sure you have a strategy? *Academy of Management Executive*, 19, 51–62.

Johnson, S. The genius of the tinkerer. *Wall Street Journal*. Retrieved from <http://online.wsj.com/article/SB10001424052748703989304575503730101860838.html>.

Ketchen, D. J., Snow, C., & Street, V. 2004. Improving firm performance by matching strategic decision making processes to competitive dynamics. *Academy of Management Executive*, 19(4), 29–43.

Kim, W. C., & Mauborgne, R. 2004, October. Blue ocean strategy. *Harvard Business Review*, 76–85.

Monster Mini Golf, KISS Mini Golf to rock Las Vegas this fall [Press release]. 2011, April 28. Monster Mini Golf website. Retrieved from <http://www.monsterminigolf.com/mmgkiss.html>.

Rosmarin, R. 2006, February 7. Nintendo's new look. *Forbes.com*. Retrieved from http://www.forbes.com/2006/02/07/xbox-ps3-revolution-cx_rr_0207nintendo.html.

Turisas, href="http://www.turisas.com/site/biography/"><http://www.turisas.com/site/biography/>.

Upson, J., Ketchen, D. J., Connelly, B., & Ranft, A. Forthcoming. Competitor analysis and foothold moves. *Academy of Management Journal*.

6.3 Responding to Competitors' Moves

Table 6.6 Responding to Rivals' Moves

Famed military strategist Carl von Clausewitz once quipped, "The best defense is a good offense." We illustrate a number of key issues surrounding whether and how firms respond when put on the defensive by rivals.

Speed of response is important when under attack. A slow response might lead a beverage firm, for example, to be crushed by the competition. However, despite the fact that RC Cola has been responsible for many innovations in the soft drink industry such as diet and caffeine-free colas, the quick responses of Coca-Cola and Pepsi have kept RC Cola from taking market share from them.

Multipoint competition is a situation where a firm faces the same rival in more than one market. Such dynamics can set off wildfires such as in the case of cigarette makers R.J. Reynolds (RJR) and Philip Morris, who compete head-to-head worldwide. When threatened in one market, firms often retaliate in other geographic regions.

Mutual forbearance arises when rivals each realize that they have more to lose through aggression against each other than they can gain. United Airlines' decision to not compete in some markets dominated by Southwest Airlines provides an example of this dynamic.

Three main options are available for **responding to a disruptive innovation**: ignore the disruption, engage in a counterattack using different goods and/or services, or directly match the competitor's move. When online stock trading emerged as a disruptive innovation in the brokerage industry, Merrill Lynch chose the third option and formed its own Internet-based unit.

Fighting brands are lower-end brands that a firm introduces to try to protect the firm's market share without damaging the firm's existing brands. General Motor's Geo line of inexpensive automobiles and Delta's Song brand were fighting brands intended to keep their owners from suffering knockout blows.

Learning Objectives

1. Know the three factors that determine the likelihood of a competitor response.
2. Understand the importance of speed in competitive response.
3. Describe how mutual forbearance can be beneficial for firms engaged in multipoint competition.
4. Explain two ways firms can respond to disruptive innovations.
5. Understand the importance of fighting brands as a competitive response.

In addition to choosing what moves their firm will make, executives also have to decide whether to respond to moves

made by rivals (Table 6.6 “Responding to Rivals’ Moves”). Figuring out how to react, if at all, to a competitor’s move ranks among the most challenging decisions that executives must make. Research indicates that three factors determine the likelihood that a firm will respond to a competitive move: awareness, motivation, and capability. These three factors together determine the level of competition tension that exists between rivals (Table 6.7 “Competitive Tension: The A-M-C Framework”).

Table 6.7 Competitive Tension: The A-M-C Framework

Bridges and rubber bands have been known to snap under too much tension. In a similar vein, firms experience competitive tension with their competitors. Three factors help to explain the likelihood that a firm will respond aggressively to rivals’ competitive actions. We explain each of these factors below.

Awareness	Like a patrolman walking his beat, executives must watch out for moves by competitors that can steal sales from their firm.
Motivation	Newton’s third law of motion states that for every action there is an equal and opposite reaction. Just like a little kid who cries “He hit me first!” when being admonished for hitting a classmate, executives will be highly motivated to retaliate when a rival makes a competitive move.
Capability	Famed literary figure Johann Wolfgang von Goethe once said, “Thinking is easy, acting is difficult.” Like a firefighter that puts as many tools at her disposal as possible, firms must possess plans, as well as resources, to respond to the actions of their rivals.

An analysis of the “razor wars” illustrates the roles that these factors play (Ketchen, et. al., 2004). Consider Schick’s attempt to grow in the razor-system market with its introduction of the Quattro. This move was widely publicized and supported by a \$120 million advertising budget. Therefore, its main competitor, Gillette, was well *aware* of the move. Gillette’s *motivation* to respond was also high. Shaving products are a vital market for Gillette, and Schick has become an increasingly formidable competitor since its acquisition by Energizer. Finally, Gillette was very *capable* of responding, given its vast resources and its dominant role in the industry. Because all three factors were high, a strong response was likely. Indeed, Gillette made a preemptive strike with the introduction of the Sensor 3 and Venus Devine a month before the Schick Quattro’s projected introduction.

Although examining a firm’s awareness, motivation, and capability is important, the results of a series of moves and countermoves are often difficult to predict and miscalculations can be costly. The poor response by Kmart and other retailers to Walmart’s growth in the late 1970s illustrates this point. In discussing Kmart’s parent corporation (Kresge), a stock analyst at that time wrote, “While we don’t expect Kresge to stage any massive invasion of Walmart’s existing territory, Kresge could logically act to contain Walmart’s geographical expansion...Assuming some containment policy on Kresge’s part, Walmart could run into serious problems in the next few years.” Kmart executives also received but ignored early internal warnings about Walmart. A former member of Kmart’s board of directors lamented, “I tried to advise the company’s management of just what a serious threat I thought [Sam Walton, founder of Walmart] was. But it wasn’t until fairly recently that they took him seriously.” While the threat of Walmart growth was apparent to some observers, Kmart executives failed to respond. Competition with Walmart later drove Kmart into bankruptcy.

Speed Kills

Executives in many markets must cope with a rapid-fire barrage of attacks from rivals, such as head-to-head advertising campaigns, price cuts, and attempts to grab key customers. If a firm is going to respond to a competitor’s move, doing so quickly is important. If there is a long delay between an attack and a response, this generally provides the attacker with

an edge. For example, PepsiCo made the mistake of waiting fifteen months to copy Coca-Cola's May 2002 introduction of Vanilla Coke. In the interim, Vanilla Coke carved out a significant market niche; 29 percent of US households had purchased the beverage by August 2003, and 90 million cases had been sold.

In contrast, fast responses tend to prevent such an edge. Pepsi's spring 2004 announcement of a midcalorie cola introduction was quickly followed by a similar announcement by Coke, signaling that Coke would not allow this niche to be dominated by its longtime rival. Thus, as former General Electric CEO Jack Welch noted in his autobiography, success in most competitive rivalries "is less a function of grandiose predictions than it is a result of being able to respond rapidly to real changes as they occur. That's why strategy has to be dynamic and anticipatory."

So... We Meet Again

Multipoint competition adds complexity to decisions about whether to respond to a rival's moves. With **multipoint competition**, a firm faces the same rival in more than one market. Cigarette makers R. J. Reynolds (RJR) and Philip Morris, for example, square off not only in the United States but also in many countries around the world. When a firm has one or more multipoint competitors, executives must realize that a competitive move in a market can have effects not only within that market but also within others. In the early 1990s, RJR started using lower-priced cigarette brands in the United States to gain customers. Philip Morris responded in two ways. The first response was cutting prices in the United States to protect its market share. This started a price war that ultimately hurt both companies. Second, Philip Morris started building market share in Eastern Europe where RJR had been establishing a strong position. This combination of moves forced RJR to protect its market share in the United States and neglect Eastern Europe.

If rivals are able to establish mutual forbearance, then multipoint competition can help them be successful. **Mutual forbearance** occurs when rivals do not act aggressively because each recognizes that the other can retaliate in multiple markets. In the late 1990s, Southwest Airlines and United Airlines competed in some but not all markets. United announced plans to form a new division that would move into some of Southwest's other routes. Southwest CEO Herb Kelleher publicly threatened to retaliate in several shared markets. United then backed down, and Southwest had no reason to attack. The result was better performance for both firms. Similarly, in hindsight, both RJR and Philip Morris probably would have been more profitable had RJR not tried to steal market share in the first place. Thus recognizing and acting on potential forbearance can lead to better performance through firms not competing away their profits, while failure to do so can be costly.

Responding to a Disruptive Innovation

When a rival introduces a disruptive innovation that conflicts with the industry's current competitive practices, such as the emergence of online stock trading in the late 1990s, executives choose from among three main responses. First, executives may believe that the innovation will not replace established offerings entirely and thus may choose to focus on their traditional modes of business while ignoring the disruption. For example, many traditional bookstores such as Barnes & Noble did not consider book sales on Amazon to be a competitive threat until Amazon began to take market share from them. Second, a firm can counter the challenge by attacking along a different dimension. For example, Apple responded to the direct sales of cheap computers by Dell and Gateway by adding power and versatility to its products. The third possible response is to simply match the competitor's move. Merrill Lynch, for example, confronted online trading by forming its own Internet-based unit. Here the firm risks cannibalizing its traditional business, but executives may find that their response attracts an entirely new segment of customers.

Fighting Brands: Get Ready to Rumble

A firm's success can be undermined when a competitor tries to lure away its customers by charging lower prices for its goods or services. Such a scenario is especially scary if the quality of the competitor's offerings is reasonably comparable to the firm's. One possible response would be for the firm to lower its prices to prevent customers from abandoning

it. This can be effective in the short term, but it creates a long-term problem. Specifically, the firm will have trouble increasing its prices back to their original level in the future because charging lower prices for a time will devalue the firm's brand and make customers question why they should accept price increases.

The creation of a fighting brand is a move that can prevent this problem. A **fighting brand** is a lower-end brand that a firm introduces to try to protect the firm's market share without damaging the firm's existing brands. In the late 1980s, General Motors (GM) was troubled by the extent to which the sales of small, inexpensive Japanese cars were growing in the United States. GM wanted to recapture lost sales, but it did not want to harm its existing brands, such as Chevrolet, Buick, and Cadillac, by putting their names on low-end cars. GM's solution was to sell small, inexpensive cars under a new brand: Geo.

Interestingly, several of Geo's models were produced in joint ventures between GM and the same Japanese automakers that the Geo brand was created to fight. A sedan called the Prizm was built side by side with the Toyota Corolla by the New United Motor Manufacturing Incorporated (NUMMI), a factory co-owned by GM and Toyota. The two cars were virtually identical except for minor cosmetic differences. A smaller car (the Metro) and a compact sport utility vehicle (the Tracker) were produced by a joint venture between GM and Suzuki. By 1998, the US car market revolved around higher-quality vehicles, and the low-end Geo brand was discontinued.



The Geo brand was known for its low price and good gas mileage, not for its styling.

[Wikimedia Commons](#) – public domain.

Some fighting brands are rather short lived. Merck's failed attempt to protect market share in Germany by creating a fighting brand is an example. Zocor, a treatment for high cholesterol, was set to lose its German patent in 2003. Merck tried to keep its high profit margin for Zocor intact until the patent expired as well as preparing for the inevitable competition with generic drugmakers by creating a lower-priced brand, Zocor MSD. Once the patent expired, however, the new brand was not priced low enough to keep customers from switching to generics. Merck soon abandoned the Zocor MSD brand (Ritson, 2009).

Two major airlines experienced similar futility. In response to the growing success of discount airlines such as Southwest, AirTran, Jet Blue, and Frontier, both United Airlines and Delta Airlines created fighting brands. United launched Ted in 2004 and discontinued it in 2009. Delta's Song had an even shorter existence. It was started in 2003 and

was ended in 2006. Southwest's acquisition of AirTran in 2011 created a large airline that may make United and Delta lament that they were not able to make their own discount brands successful.

Despite these missteps, the use of fighting brands is a time-tested competitive move. For example, very successful fighting brands were launched forty years apart by Anheuser-Busch and Intel. After Anheuser-Busch increased the prices charged by its existing brands in the mid-1950s (Budweiser and Michelob), smaller brewers started gaining market share. In response, Anheuser-Busch created a lower-priced brand: Busch. The new brand won back the market share that had been lost and remains an important part of Anheuser-Busch's brand portfolio today. In the late 1990s, silicon chipmaker Advanced Micro Devices started undercutting the prices charged by industry leader Intel. Intel responded by creating the Celeron brand of silicon chips, a brand that has preserved Intel's market share without undermining profits. Wise strategic moves such as the creation of the Celeron brand help explain why Intel ranks thirty-second on *Fortune* magazine's list of the "World's Most Admired Corporations." Meanwhile, Anheuser-Busch is the second most admired beverage firm, ranking behind Coca-Cola.

Key Takeaway

- When threatened by the competitive actions of rivals, firms possess numerous ways to respond, depending on the severity of the threat.

Exercises

1. Why might local restaurants not be in the position to respond to large franchises or chains? What can local restaurants do to avoid being ruined by chain restaurants?
2. If a new alternative fuel was found in the auto industry, what are two ways existing car manufacturers might respond to this disruptive innovation?
3. How might a firm such as Apple computers use a fighting brand?

References

Ketchen, D. J., Snow, C., & Street, V. 2004. Improving firm performance by matching strategic decision making processes to competitive dynamics. *Academy of Management Executive*, 19(4) 29-43.

Ritson, M. 2009, October. Should you launch a fighter brand? *Harvard Business Review*, 65-81.

6.4 Making Cooperative Moves

Learning Objectives

1. Know the four types of cooperative moves.
2. Understand the benefits of taking quick and decisive action.

In addition to competitive moves, firms can benefit from cooperating with one another. Cooperative moves such as forming joint ventures and strategic alliances may allow firms to enjoy successes that might not otherwise be reached (Table 6.8 “Making Cooperative Moves”). This is because cooperation enables firms to share (rather than duplicate) resources and to learn from one another’s strengths. Firms that enter cooperative relationships take on risks, however, including the loss of control over operations, possible transfer of valuable secrets to other firms, and possibly being taken advantage of by partners (Ketchen, et. al., 2004).

Joint Ventures

A **joint venture** is a cooperative arrangement that involves two or more organizations each contributing to the creation of a new entity. The partners in a joint venture share decision-making authority, control of the operation, and any profits that the joint venture earns.

Sometimes two firms create a joint venture to deal with a shared opportunity. In April 2011, a joint venture was created between Merck and Sun Pharmaceutical Industries Ltd., an Indian pharmaceutical company. The purpose of the joint venture is to create and sell generic drugs in developing countries. In a press release, a top executive at Sun stressed that each side has important strengths to contribute: “This joint venture reinforces [Sun’s] strategy of partnering to launch products using our highly innovative delivery technologies around the world. Merck has an unrivalled reputation as a world leading, innovative, research-driven pharmaceutical company (Merck, 2004).” Both firms contributed executives to the new organization, reflecting the shared decision making and control involved in joint ventures.

In other cases, a joint venture is designed to counter a shared threat. In 2007, brewers SABMiller and Molson Coors Brewing Company created a joint venture called MillerCoors that combines the firms’ beer operations in the United States. Miller and Coors found it useful to join their US forces to better compete against their giant rival Anheuser-Busch, but the two parent companies remain separate. The joint venture controls a wide array of brands, including Miller Lite, Coors Light, Blue Moon Belgian White, Coors Banquet, Foster’s, Henry Weinhard’s, Icehouse, Keystone Premium, Leinenkugel’s, Killian’s Irish Red, Miller Genuine Draft, Miller High Life, Milwaukee’s Best, Molson Canadian, Peroni Nastro Azzurro, Pilsner Urquell, and Red Dog. This diverse portfolio makes MillerCoors a more potent adversary for Anheuser-Busch than either Miller or Coors would be alone.

Table 6.8 Making Cooperative Moves

Franklin Roosevelt once quipped, “Competition has been shown to be useful up to a certain point and no further, but cooperation, which is the thing we must strive for today, begins where competition leaves off.” We illustrate four commonly used cooperative moves used by firms below.

Join ventures involve two or more organizations that contribute to the creation of a new entity. For example, Hong Kong Disneyland is a joint venture between the government of Hong Kong and the Walt Disney Company. While the park consists of Disney mainstays such as Main Street, U.S.A., Fantasyland, Adventureland, and Tomorrowland, the park also incorporates elements of Chinese culture such as adherence to the rules of Feng Shui—a set of aesthetic design principles believe to promote positive energy.

Strategic alliances are cooperative arrangements between two or more organizations that do not involve creating new entities. For example, a strategic alliance between Merck and PAREXEL International Corporation was recently announced with the goal of collaborating on biotechnology efforts known as biosimilars—a term used to describe subsequent versions of innovative drugs.

Colocation refers to a situation when goods and services offered under different brands are located very close to each other. Noting once common example of colocation, a comedian once joke that La Quinta was Spanish for “Next to Denny’s.” Both hotels and restaurants are often colocated alongside freeway exits to allow numerous choices for road-weary travelers.

Coopetition is a term that refers to the blending of competition and cooperation between two firms. Toyota and General Motors’ creation of jointly owned New United Motor Manufacturing incorporated (NUMMI) allowed for collaboration on automobile designs while Toyota and GM continued to compete for market share worldwide. The NUMMI experience also inspired the 1986 comedy *Gung Ho*.

Strategic Alliances

A **strategic alliance** is a cooperative arrangement between two or more organizations that does not involve the creation of a new entity. In June 2011, for example, Twitter announced the formation of a strategic alliance with Yahoo! Japan. The alliance involves relevant Tweets appearing within various functions offered by Yahoo! Japan (Rao, 2014). The alliance simply involves the two firms collaborating as opposed to creating a new entity together.

The pharmaceutical industry is the location of many strategic alliances. In January 2011, for example, a strategic alliance between Merck and PAREXEL International Corporation was announced. Within this alliance, the two companies collaborate on biotechnology efforts known as biosimilars. This alliance could be quite important to Merck because the global market for biosimilars has been predicted to rise from \$235 million in 2010 to \$4.8 billion by 2015 (PRWeb, 2011).

Colocation

Colocation occurs when goods and services offered under different brands are located close to one another. In many cities, for examples, theaters and art galleries are clustered together in one neighborhood. Auto malls that contain several different car dealerships are found in many areas. Restaurants and hotels are often located near on another too. By providing customers with a variety of choices, a set of colocated firms can attract a bigger set of customers collectively than the sum that could be attracted to individual locations. If a desired play is sold out, a restaurant overcrowded, or a hotel overbooked, many customers simply patronize another firm in the area.

Because of these benefits, savvy executives in some firms colocate their own brands. The industry that Brinker International competes within is revealed by its stock ticker symbol: EAT. This firm often sites outlets of the multiple restaurant chains it owns on the same street. Marriott’s Courtyard and Fairfield Inn often sit side by side. Yum! Brands

takes this clustering strategy one step further by locating more than one of its brands—A&W, Long John Silver's, Taco Bell, Kentucky Fried Chicken, and Pizza Hut—within a single store.

Co-opetition

Although competition and cooperation are usually viewed as separate processes, the concept of **co-opetition** highlights a complex interaction that is becoming increasingly popular in many industries. Ray Noorda, the founder of software firm Novell, coined the term to refer to a blending of competition and cooperation between two firms. As explained in this chapter's opening vignette, for example, Merck and Roche are rivals in some markets, but the firms are working together to develop tests to detect cancer and to promote a hepatitis treatment. NEC (a Japanese electronics company) has three different relationships with Hewlett-Packard Co.: customer, supplier, and competitor. Some units of each company work cooperatively with the other company, while other units are direct competitors. NEC and Hewlett-Packard could be described as "frienemies"—part friends and part enemies.

Toyota and General Motors provide a well-known example of co-opetition. In terms of cooperation, Toyota and GM vehicles were produced side by side for many years at the jointly owned New United Motor Manufacturing Incorporated (NUMMI) in Fremont, California. While Honda and Nissan used wholly owned plants to begin producing cars in the United States, NUMMI offered Toyota a lower-risk means of entering the US market. This entry mode was desirable to Toyota because its top executives were not confident that Japanese-style management would work in the United States. Meanwhile, the venture offered GM the chance to learn Japanese management and production techniques—skills that were later used in GM's facilities. NUMMI offered both companies economies of scale in manufacturing and the chance to collaborate on automobile designs. Meanwhile, Toyota and GM compete for market share around the world. In recent years, the firms have been the world's two largest automakers, and they have traded the top spot over time.

In their book titled, not surprisingly, *Co-opetition*, A. M. Brandenberger and B. J. Nalebuff suggest that cooperation is generally best suited for "creating a pie," while competition is best suited for "dividing it up (Brandenberger & Nalebuff, 1996)." In other words, firms tend to cooperate in activities located far in the value chain from customers, while competition generally occurs close to customers. The NUMMI example illustrates this tendency—GM and Toyota worked together on design and manufacturing but worked separately on distribution, sales, and marketing. Similarly, a research study focused on Scandinavian firms found that, in the mining equipment industry, firms cooperated in material development, but they competed in product development and marketing. In the brewing industry, firms worked together on the return of used bottles but not in distribution (Bengtsson & Kock, 2000).

Get Moving!

Figure 6.9 Get Moving!

The following story, based on the poem "Brief Thoughts on Maps" by Miroslav Holub, highlights the importance of taking strategic action in the face of danger.



A lieutenant once sent out a patrol into the Alps during a harsh snowstorm. After a couple of days of snow, he began to fear that he had dispatched his men to their deaths.



But, just as all hope was about to be lost, the group returned.



The lieutenant began to question his patrol. How did they make it back?



One of the men admitted that at first they panicked and began waiting to meet their fate. But then one of the soldiers found a map in his pocket, which helped to calm everyone down.



So, the patrol made their camp and lasted out the snowstorm. After the snow subsided, they used the map to get their bearings and they found their way back, as simple as that.



The lieutenant was stunned when he realized that the map was not even of the Alps. The map in the soldier's pocket was actually one of a different mountain range.

The point of this tale is that sometimes, any old map will do. In relation to the competitive and cooperative moves a business may take, it is important for executives to avoid "paralysis by analysis" and get moving. Any good competitive move provides a useful starting point that executives can learn from and then adjust their strategies as needed.

Joseph Addison, an eighteenth-century poet, is often credited with coining the phrase "He who hesitates is lost." This proverb is especially meaningful in today's business world. It is easy for executives to become paralyzed by the dizzying array of competitive and cooperative moves available to them. Given the fast-paced nature of most industries today, hesitation can lead to disaster. Some observers have suggested that competition in many settings has transformed into [hypercompetition](#), which involves very rapid and unpredictable moves and countermoves that can undermine competitive advantages. Under such conditions, it is often better to make a reasonable move quickly

rather than hoping to uncover the perfect move through extensive and time-consuming analysis (Figure 6.9 “Get Moving!”).

The importance of learning also contributes to the value of adopting a “get moving” mentality. This is illustrated in Miroslav Holub’s poem “Brief Thoughts on Maps.” The discovery that one soldier had a map gave the soldiers the confidence to start moving rather than continuing to hesitate and remaining lost. Once they started moving, the soldiers could rely on their skill and training to learn what would work and what would not. Similarly, success in business often depends on executives learning from a series of competitive and cooperative moves, not on selecting ideal moves.

Key Takeaway

- Cooperating with other firms is sometimes a more lucrative and beneficial approach than directly attacking competing firms.

Exercises

1. How could a family jewelry store use one of the cooperative moves mentioned in this section?? What type of organization might be a good cooperative partner for a family jewelry store?
2. Why is it that “any old map will do” sometimes in relation to strategic actions?

References

- Bengtsson, M., & Kock, S. 2000. “Coopetition” in business networks—to cooperate and compete simultaneously. *Industrial Marketing Management*, 29(5), 411–426.
- Brandenberger, A. M., & Nalebuff, B. J. 1996. *Co-opetition*. New York, NY: Doubleday.
- Ketchen, D. J., Snow, C., & Street, V. 2004. Improving firm performance by matching strategic decision making processes to competitive dynamics. *Academy of Management Executive*, 19(4), 29–43.
- Merck & Co., Inc., and Sun Pharma establish joint venture to develop and commercialize novel formulations and combinations of medicines in emerging markets [Press release]. 2011, April 11. Merck website. Retrieved from <http://www.merck.com/licensing/our-partnership/sun-partnership.html>.
- PRWeb, Global biosimilars market to reach US\$4.8 billion by 2015, according to a new report by Global Industry Analysts, Inc. [Press release]. 2011, February 15. PRWeb website. Retrieved from http://www.prweb.com/releases/biosimilars/human_growth_hormone/prweb8131268.htm.
- Rao, L. 2011, June 14. Twitter announces “strategic alliance” with Yahoo Japan [Blog post]. Techcrunch website. Retrieved from <http://www.techcrunch.com/2011/06/14/twitter-announces-firehose-partnership-with-yahoo-japan>.

6.5 Conclusion

This chapter explains competitive and cooperative moves that executives may choose from when challenged by competitors. Executives may choose to act swiftly by being a first mover in their market, and their firms may benefit if they are offering disruptive innovations to an industry. Executives may also choose a more conservative route by establishing a foothold within an area that can serve as a launching point or by avoiding existing competitors overall by using a blue ocean strategy. When firms are on the receiving end of a competitive attack, they are likely to retaliate to the extent that they possess awareness, motivation, and capability. While responding quickly is often beneficial, mutual forbearance can also be an effective approach. When firms encounter a potentially disruptive innovation, they might ignore the threat, confront it head on, or attack along a different dimension. Executives may also react to competitive attacks by using fighting brands. Rather than engaging in a head-to-head battle with competitors, executives may also choose to engage in a cooperative strategy such as a joint venture, strategic alliance, colocation, or co-opetition. Regardless of the decision executives make, in many cases any attempt to act on a viable road map will result in progress that will get the firm moving in the right direction.

Exercises

1. Divide your class into four or eight groups, depending on the size of the class. Each group should select a different industry. Find examples of competitive and cooperative moves that you would recommend if hired as a consultant for a firm in that industry.
2. What types of cooperative moves could your college or university use to partner with local, national, and international businesses? What benefits and risks would be created by making these moves?

Chapter 7: Competing in International Markets

Chapter 7: Competing in International Markets

7.1 Competing in International Markets

7.2 Advantages and Disadvantages of Competing in International Markets

7.3 Drivers of Success and Failure When Competing in International Markets

7.4 Types of International Strategies

7.5 Options for Competing in International Markets

7.6 Conclusion

7.1 Competing in International Markets

Learning Objectives

After reading this chapter, you should be able to understand and articulate answers to the following questions:

1. What are the main benefits and risks of competing in international markets?
2. What is the “diamond model,” and how does it help explain why some firms compete better in international markets than others?
3. What are the various global strategies that firms can adopt?
4. What forms of involvement are available to firms that seek to compete in international markets?

Kia Picks Up Speed



Kia is enjoying accelerated growth within the global automobile industry.

Buie – [Kia](#) – CC BY-NC-ND 2.0.

On June 2, 2011, South Korean automaker Kia announced plans for a major expansion of its American production facility. Capacity at Kia Motors Manufacturing Georgia Inc. (KMMG) was slated to expand 20 percent from 300,000 to 360,000 vehicles per year. In addition to the crossover utility vehicle Sorento, the plant would

begin making a sedan named the Optima in September 2011. The expansion of the plant was estimated to cost \$100 million and was expected to create 1,000 new jobs (Kia Motors Manufacturing Georgia, 2011).

This ambitious growth was made possible by Kia's superb performance in the US market. KMMG had started building vehicles less than two years earlier after being constructed for a cost of \$1 billion. In 2010, yearly sales in the United States climbed above 350,000 vehicles. Kia's overall share of the US market increased in 2010 for the sixteenth consecutive year. In May 2011, Kia sold more than 48,000 cars and trucks in United States, an increase of more than 53 percent from May 2010 sales levels. The Optima led the way with a whopping 210 percent increase in sales.

Kia was not the only beneficiary of its success. KMMG's location of West Point, Georgia, had been economically devastated when its homegrown textile company, WestPoint Home, shut down its local factories to take advantage of lower labor prices overseas. Following a fierce competition with towns in Mississippi, Kentucky, and other states, West Point was selected in 2006 as the site of Kia's first US manufacturing facility. To win the plant, state and local authorities offered Kia more than \$400 million worth of incentives, including tax breaks, free land, and infrastructure creation.

Georgia's return on this investment included two thousand new jobs at the plant as well as hundreds of jobs at suppliers that set up shop to support KMMG. The neighboring state of Alabama benefited from KMMG's success too. As of June 2011, nearly sixty companies spread across twenty-three Alabama counties supplied parts or services to KMMG (Kent, 2011).

The name "Kia" means to arise or come up out of Asia (Kia). This name is very appropriate; Kia rose from humble beginnings as a maker of bicycle parts in 1944 to become a global player in the automobile industry. As of 2011, Kia was producing more than 2.1 million vehicles per year in eight countries. Kias were sold in 172 countries. Kia employed more than 44,000 people and enjoyed annual revenues in excess of \$20 billion. Fellow South Korean automaker Hyundai owned just over 33 percent of Kia, and the two firms strengthened each other through collaboration. When taking all of these facts into consideration, Kia's slogan—The Power to Surprise—had to make its rivals wonder what surprises the Korean upstart might have in store for them next.



Workers in Georgia build Sorentos for South Korea-based Kia.

[Wikimedia Commons](#) – public domain.

References

Kent, D. 2011, June 19. Kia production in Georgia helping companies across Alabama. *al.com*. Retrieved from http://blog.al.com/businessnews/2011/06/kia_production_in_georgia_help.html.

Kia, Frequently asked questions. Kia website. Retrieved from <http://www.kia.com/#/faq/>

Kia Motors Manufacturing Georgia, href="http://www.kmmgusa.com/2011/06/kia-motors-manufacturing-georgia-begins-expansion-projects-to-support-increased%20-volume-beginning-

in-2012/"><http://www.kmmgusa.com/2011/06/kia-motors-manufacturing-georgia-begins-expansion-projects-to-support-increased-volume-beginning-in-2012/>.

7.2 Advantages and Disadvantages of Competing in International Markets

Learning Objectives

1. Understand the potential benefits of competing in international markets.
2. Understand the risks faced when competing in international markets.

As Kia's experience illustrates, international business is a huge segment of the world's economic activity. Amazingly, current projections suggest that, within a few years, the total dollar value of trade across national borders will be greater than the total dollar value of trade within all of the world's countries combined. One driver of the rapid growth of international business over the past two decades has been the opening up of large economies such as China and Russia that had been mostly closed off to outside investors.

Table 7.1 Why Compete in New Markets?

The domestication of the camel by Arabian travelers fueled two early examples of international trade: spices and silk. Today, camels have been replaced by airplanes, trains, and ships, and international trade is more alluring than ever. Here are three key reasons why executives are enticed to enter new markets.

Access to new customers	China's population is roughly four times as large as that of the United States. While political, cultural, and economic differences add danger to trade with China, the immense size of the Chinese market appeals to American firms.
Lowering costs	Access to cheaper raw materials and labor have led to considerable outsourcing and offshoring. Call centers in India have become so sophisticated that many Indian customer service representatives take extensive language training to learn regional U.S. dialects.
Diversification of business risk	Business risk refers to the risk of an operation failing. Competing in multiple markets allows this risk to be spread out among many economies and customers. Coca-Cola, for example, has a presence in over 200 markets worldwide.

The United States enjoys the world's largest economy. As an illustration of the power of the American economy, consider that, as of early 2011, the economy of just one state—California—would be the eighth largest in the world if it were a country, ranking between Italy and Brazil (The Economist, 2011). The size of the US economy has led American commerce to be very much intertwined with international markets. In fact, it is fair to say that every business is affected by international markets to some degree. Tiny businesses such as individual convenience stores and clothing boutiques sell products that are imported from abroad. Meanwhile, corporate goliaths such as General Motors (GM), Coca-Cola, and Microsoft conduct a great volume of business overseas.

Access to New Customers

Perhaps the most obvious reason to compete in international markets is gaining access to new customers. Although the United States enjoys the largest economy in the world, it accounts for only about 5 percent of the world's population. Selling goods and services to the other 95 percent of people on the planet can be very appealing, especially for companies whose industry within their home market are saturated ([Table 7.1 "Why Compete in New Markets?"](#)).

Few companies have a stronger "All-American" identity than McDonald's. Yet McDonald's is increasingly reliant on sales outside the United States. In 2006, the United States accounted for 34 percent of McDonald's revenue, while Europe accounted for 32 percent and 14 percent was generated across Asia, the Middle East, and Africa. By 2011, Europe was McDonald's biggest source of revenue (40 percent), the US share had fallen to 32 percent, and the collective contribution of Asia, the Middle East, and Africa had jumped to 23 percent. With less than one-third of its sales being generated in its home country, McDonald's is truly a global powerhouse.



Levi's jeans are appreciated by customers worldwide, as shown by this balloon featured at the Putrajaya International Hot Air Balloon Fiesta.

Kevin Poh – [2nd Putrajaya International Hot Air Balloon Fiesta 2010](#) – CC BY 2.0.

China and India are increasingly attractive markets to US firms. The countries are the two most populous in the world. Both nations have growing middle classes, which means that more and more people are able to purchase goods and services that are not merely necessities of life. This trend has created tremendous opportunities for some firms. In the first half of 2010, for example, GM sold more vehicles in China than it sold in the United States (1.2 million vs. 1.08

million). This gap seemed likely to expand; in the first half of 2010, GM's sales in China increased nearly 50 percent relative to 2009 levels, while sales in the United States rose 15 percent (Isidore, 2010).

Lowering Costs

Many firms that compete in international markets hope to gain cost advantages. If a firm can increase its sales volume by entering a new country, for example, it may attain economies of scale that lower its production costs. Going international also has implications for dealing with suppliers. The growth that overseas expansion creates leads many businesses to purchase supplies in greater numbers. This can provide a firm with stronger leverage when negotiating prices with its suppliers.

Offshoring has become a popular yet controversial means for trying to reduce costs. Offshoring involves relocating a business activity to another country. Many American companies have closed down operations at home in favor of creating new operations in countries such as China and India that offer cheaper labor. While offshoring can reduce a firm's costs of doing business, the job losses in the firm's home country can devastate local communities. For example, West Point, Georgia, lost approximately 16,000 jobs in the 1990s and 2000s as local textile factories were shut down in favor of offshoring (Copeland, 2010). Fortunately for the town, Kia's decision to locate its first US factory in West Point has improved the economy in the past few years. In another example, Fortune Brands saved \$45 million a year by relocating several factories to Mexico, but the employee count in just one of the affected US plants dropped from 1,160 to 350.

A growing number of US companies are finding that offshoring is not providing the benefits they had expected. This has led to a new phenomenon known as **reshoring**, whereby jobs that had been sent overseas are returning home. In some cases, the quality provided by workers overseas is not good enough. Carbonite, a seller of computer backup services, found that its call center in Boston was providing much stronger customer satisfaction than its call center in India. The Boston operation's higher rating was attained even though it handled the more challenging customer complaints. As a result, Carbonite plans to shift 250 call center jobs back to the United States by the end of 2012.



Concerns about customer service are leading some American firms to shift their call centers back to the United States.

The Open University – [Call Centre](#) – CC BY-NC-ND 2.0.

In other cases, the expected cost savings have not materialized. NCR had been making ATMs and self-service checkout systems in China, Hungary, and Brazil. These machines can weigh more than a ton, and NCR found that shipping them from overseas plants back to the United States was extremely expensive. NCR hired 500 workers to start making the ATMs and checkout systems at a plant in Columbus, Georgia. NCR's plans call for 370 more jobs to be added at the plant by 2014. Similarly, General Electric announced plans to hire approximately 1,300 workers in Louisville, Kentucky, starting in the fall of 2011. These workers will make water heaters and refrigerators that had been produced overseas (Isidore, 2011).

Diversification of Business Risk

A familiar cliché warns “don’t put all of your eggs in one basket.” Applied to business, this cliché suggests that it is dangerous for a firm to operate in only one country. **Business risk** refers to the potential that an operation might fail. If a firm is completely dependent on one country, negative events in that country could ruin the firm. Just like spreading one’s eggs into multiple baskets reduces the chances that all eggs will be broken, business risk is reduced when a firm is involved in multiple countries.



Firms can reduce business risk by competing in a variety of international markets. For example, the amp m convenience store chain has locations in the United States, Mexico, Brazil, and Japan.

[Wikimedia Commons](#) – CC BY-SA 3.0.

Consider, for example, natural disasters such as the earthquakes and tsunami that hit Japan in 2011. If Japanese automakers such as Toyota, Nissan, and Honda sold cars only in their home country, the financial consequences could have been grave. Because these firms operate in many countries, however, they were protected from being ruined by events in Japan. In other words, these firms diversified their business risk by not being overly dependent on their Japanese operations.

American cigarette companies such as Philip Morris and R. J. Reynolds are challenged by trends within the United States and Europe. Tobacco use in these areas is declining as more laws are passed that ban smoking in public areas and in restaurants. In response, cigarette makers are attempting to increase their operations within countries where smoking remains popular to remain profitable over time.

In 2006, for example, Philip Morris spent \$5.2 billion to purchase a controlling interest in Indonesian cigarette maker Sampoerna. This was the biggest acquisition ever in Indonesia by a foreign company. Tapping into Indonesia's population of approximately 230 million people was attractive to Philip Morris in part because nearly two-thirds of men are smokers, and smoking among women is on the rise. As of 2007, Indonesia was the fifth-largest tobacco market in the world, trailing only China, the United States, Russia, and Japan. To appeal to local preferences for cigarettes flavored with cloves, Philip Morris introduced a variety of its signature Marlboro brand called Marlboro Mix 9 that includes cloves in its formulation (The Two Malcontents, 2007).



Trends in the decline of cigarette use in the United States and Europe may snuff out profits enjoyed by brands such as Marlboro.

[Wikimedia Commons](#) – public domain.

Figure 7.2 Entering New Markets: Worth the Risk?

In 1957, a game developed by Oscar-winning film director Albert Lamorisse called “La Conquête du Monde” (“The Conquest of the World”) was released in France. Currently produced by Hasbro, the board game now simply called “Risk” continues to entice players with the allure of world domination. Firms venturing into new markets must be willing to face the three risks on the global battlefield that we outline below.



Fayjo – Risk – CC BY 2.0.

Political Risk

Although competing in international markets offers important potential benefits, such as access to new customers, the opportunity to lower costs, and the diversification of business risk, going overseas also poses daunting challenges. **Political risk** refers to the potential for government upheaval or interference with business to harm an operation within a country (Figure 7.2 “Entering New Markets: Worth the Risk?”). For example, the term “Arab Spring” has been used to refer to a series of uprisings in 2011 within countries such as Tunisia, Egypt, Libya, Bahrain, Syria, and Yemen. Unstable governments associated with such demonstrations and uprisings make it difficult for firms to plan for the future. Over time, a government could become increasingly hostile to foreign businesses by imposing new taxes and new regulations. In extreme cases, a firm's assets in a country are seized by the national government. This process is called **nationalization**. In recent years, for example, Venezuela has nationalized foreign-controlled operations in the oil, cement, steel, and glass industries.

Countries with the highest levels of political risk tend to be those such as Somalia, Sudan, and Afghanistan whose governments are so unstable that few foreign companies are willing to enter them. High levels of political risk are also present, however, in several of the world's important emerging economies, including India, the Philippines, Russia, and Indonesia. This creates a dilemma for firms in that these risky settings also offer enormous growth opportunities. Firms can choose to concentrate their efforts in countries such as Canada, Australia, South Korea, and Japan that have very low levels of political risk, but opportunities in such settings are often more modest (Kostigen, 2011).



Cuban leader Fidel Castro nationalized the assets of thousands of US companies after overthrowing the previous government.

Ingmar Zahorsky – Cuba – CC BY-NC-ND 2.0.

Economic Risk

Economic risk refers to the potential for a country's economic conditions and policies, property rights protections, and currency exchange rates to harm a firm's operations within a country. Executives who lead companies that do business in many different countries have to take stock of these various dimensions and try to anticipate how the dimensions will affect their companies. Because economies are unpredictable, economic risk presents executives with tremendous challenges.

Consider, for example, Kia's operations in Europe. In May 2009, Kia reported increased sales in ten European countries relative to May 2008. The firm enjoyed a 62 percent year-to-year increase in Slovakia, 58 percent in Austria, 50 percent in Gibraltar, 49 percent in Sweden, 43 percent in Poland, 24 percent in Germany, 21 percent in the United Kingdom, 13 percent in the Czech Republic, 6 percent in Belgium, and 3 percent in Italy (Kia). As Kia's executives planned for the future, they needed to wonder how economic conditions would influence Kia's future performance in Europe. If inflation and interest rates were to increase in a particular country, this would make it more difficult for consumers to purchase new Kias. If currency exchange rates were to change such that the euro became weaker relative to the South Korean won, this would make a Kia more expensive for European buyers.



Economic risk involves many complex and daunting elements.

Karl-Ludwig Poggemann – [Euro burning](#) – CC BY 2.0.

Cultural Risk

Table 7.3 Cultural Risk: When in Rome

The phrase “When in Rome, do as the Romans do” is used to encourage travelers to embrace local customs. An important part of fitting in is avoiding behaviors that locals consider offensive. Below we illustrate a number of activities that would go largely unnoticed in the United States but could raise concerns in other countries.

If you want to signal “Check please!” to catch the attention of your garçon in France and Belgium, remember that snapping your fingers is vulgar there.	In many Asian and Arabian countries, showing the sole of your shoe is considered rude.
Provocative dress is embraced by many Americans, but many people in Muslim countries consider a woman’s clothing to be inappropriate if it reveals anything besides the face and hands.	If everything is OK when you’re in Brazil, avoid making the “OK” hand signal. It’s the equivalent to giving someone the middle finger.
Do you pride yourself on your punctuality? You may be wasting your time in Latin American countries, where the locals tend to be about 20 minutes behind schedule.	Do not clean your plate in China. Leaving food on the plate indicates the host was so generous that the meal could not be finished.
Do not eat with your left hand in India or Malaysia. That hand is associated with unclean activities reserved for the bathroom.	In Japan, direct eye contact is viewed as impolite.

Cultural risk refers to the potential for a company’s operations in a country to struggle because of differences in language, customs, norms, and customer preferences (Table 7.3 “Cultural Risk: When in Rome”). The history of business is full of colorful examples of cultural differences undermining companies. For example, a laundry detergent company was surprised by its poor sales in the Middle East. Executives believed that their product was being skillfully promoted using print advertisements that showed dirty clothing on the left, a box of detergent in the middle, and clean clothing on the right.

A simple and effective message, right? Not exactly. Unlike English and other Western languages, the languages used in the Middle East, such as Hebrew and Arabic, involve reading from right to left. To consumers, the implication of the detergent ads was that the product could be used to take clean clothes and make the dirty. Not surprisingly, few boxes of the detergent were sold before this cultural blunder was discovered.

A refrigerator manufacturer experienced poor sales in the Middle East because of another cultural difference. The firm used a photo of an open refrigerator in its print ads to demonstrate the large amount of storage offered by the appliance. Unfortunately, the photo prominently featured pork, a type of meat that is not eaten by the Jews and Muslims who make up most of the area’s population (Ricks, 1993). To get a sense of consumers’ reactions, imagine if you saw a refrigerator ad that showed meat from a horse or a dog. You would likely be disgusted. In some parts of world, however, horse and dog meat are accepted parts of diets. Firms must take cultural differences such as these into account when competing in international markets.



This photo would not help sell refrigerators in the Middle East because it includes pork, a meat that is taboo in that part of the world.

Jonathan Haynes – [Fridge. Photo-friendly version.](#) – CC BY-SA 2.0.

Cultural differences can cause problems even when the cultures involved are very similar and share the same language. RecycleBank is an American firm that specializes in creating programs that reward people for recycling, similar to airlines’ frequent-flyer programs. In 2009, RecycleBank expanded its operations into the United Kingdom. Executives at RecycleBank became offended when the British press referred to RecycleBank’s rewards program as a “scheme.” Their concern was unwarranted, however. The word *scheme* implies sneakiness when used in the United States, but a scheme simply means a service in the United Kingdom (Maltby, 2010). Differences in the meaning of English words between the United States and the United Kingdom are also vexing to American men named Randy, who wonder why Brits giggle at the mention of their name (Table 7.4 “Watch Your Language”).

Table 7.4 Watch Your Language

Cultural differences rooted in language—even across English-speaking countries—can affect how firms do business internationally. Below we provide a few examples.

Book and movie titles are often changed in different markets to appeal to different cultural sensibilities. For example, British author J.K. Rowling’s *Harry Potter and the Philosopher’s Stone* was changed to *Harry Potter and the Sorcerer’s Stone* in the United States because of the belief that American children would find a philosopher to be boring.

Moms in the states can be seen walking with strollers in their neighborhoods, while “mums” in Ireland and the United Kingdom keep their children moving in a buggy.

In India, you are more likely to hear “no problem” than “no” as Indian nationals avoid the disappointment associated with using the word no.

The area called a trunk in America is known as the a boot in England.

Wondering what it means when a British friend asks, “What’s under your bonnet?” Open the hood of your car to offer an answer.

While Americans look for a flashlight when power goes out, a torch is the preferred term for those outside of North America.

Urban legend says that the Chevrolet Nova did not do well in Spanish speaking countries because the name translates as “no go.” The truth is that the car sold well in both Mexico and Venezuela.

Key Takeaway

- Competing in international markets involves important opportunities and daunting threats. The

opportunities include access to new customers, lowering costs, and diversification of business risk. The threats include political risk, economic risk, and cultural risk.

Exercises

1. Is offshoring ethical or unethical? Why?
2. Do you expect reshoring to become more popular in the years ahead? Why or why not?
3. Have you ever seen an advertisement that was culturally offensive? Why do you think that companies are sometimes slow to realize that their ads will offend people?

References

- Copeland, L. 2010, March 25. Kia breathes life into old Georgia textile mill town. *USA Today*. Retrieved from http://www.usatoday.com/news/nation/2010-03-24-boomtown_N.htm.
- Isidore, C. 2010, July 2. GM's Chinese sales top US. CNNMoney. Retrieved from http://money.cnn.com/2010/07/02/news/companies/gm_china/index.htm.
- Isidore, C. 2011, June 17. Made in USA: Overseas jobs come home. CNNMoney. Retrieved from http://money.cnn.com/2011/06/17/news/economy/made_in_usa/index.htm.
- Kia, Kia sales climb strongly in 10 countries in May [Press release]. Kia website. Retrieved from <http://www.kia-press.com/press/corporate/20090605-kia%20sales%20climb%20strongly%20in%2010%20countries.aspx>.
- Kostigen, T. 2011, February 25. Beware: The world's riskiest countries. Market Watch. *Wall Street Journal*. Retrieved from <http://www.marketwatch.com/story/beware-the-worlds-riskiest-countries-2011-02-25>.
- Maltby, E. 2010, January 19. Expanding abroad? Avoid cultural gaffes. *Wall Street Journal*. Retrieved from <http://online.wsj.com/article/SB10001424052748703657604575005511903147960.html>.
- Ricks, D. A. 1993. *Blunders in international business*. Cambridge, MA: Blackwell.
- The Economist, Stateside substitutes. 2011, January 2011. *The Economist*. Retrieved from http://www.economist.com/blogs/dailychart/2011/01/comparing_us_states_countries.
- The Two Malcontents, T2M. 2007, July 3. Clove-flavored Marlboro now in Indonesia [Web blog post]. Retrieved from <http://www.the-two-malcontents.com/2007/07/clove-flavored-marlboro-now-in-indonesia>.

7.3 Drivers of Success and Failure When Competing in International Markets

Learning Objectives

1. Explain the elements of the “diamond model.”
2. Understand how the model helps to explain success and failure in international markets.

The title of a book written by newspaper columnist Thomas Friedman attracted a great deal of attention when the book was released in 2005. In *The World Is Flat: A Brief History of the 21st Century*, Friedman argued that technological advances and increased interconnectedness is leveling the competitive playing field between developed and emerging countries. This means that companies exist in a “flat world” because economies across the globe are converging on a single integrated global system (Friedman, 2005). For executives, a key implication is that a firm’s being based in a particular country is ceasing to be an advantage or disadvantage.

While Friedman’s notion of business becoming a flat world is flashy and attention grabbing, it does not match reality. Research studies conducted since 2005 have found that some firms enjoy advantages based on their country of origin while others suffer disadvantages. A powerful framework for understanding how likely it is that firms based in a particular country will be successful when competing in international markets was provided by Professor Michael Porter of the Harvard Business School (Porter, 1990). The framework is formally known as “the determinants of national advantage,” but it is often referred to more simply as “the diamond model” because of its shape (Table 7.5 “Diamond Model of National Advantage”).

Table 7.5 Diamond Model of National Advantage

Diamonds may be a country’s best friend. Around half of the world’s diamonds are mined in South Africa, giving that country a unique advantage in the global diamond industry. Porter’s Determinants of National advantage (often referred to as the diamond model) includes four key dimensions that help explain why firms located in certain countries are more successful than others in particular industries.

Strategy, Structure, and Rivalry	The United States has an overall trade deficit, but it enjoys a trade surplus within the service sector. Fierce domestic competition in industries such as hotels and restaurants has helped make American firms such as Marriott and Subway important players on the world stage.
Factor Conditions	The inputs present in a country shape firm's global competitiveness. The rapid growth of Chinese manufacturers has been fueled by the availability of cheap labor.
Demand Conditions	Fussy domestic customers help firms prepare for the global arena. Japanese firms must create excellent goods to meet Japanese consumers' high expectations about quality, aesthetics, and reliability.
Related and Supporting Industries	Firms benefit when their domestic suppliers and other complementary industries are developed and helpful. Italy's fashion industry is enhanced by the abundance of fine Italian leather and well-known designers.

According to the model, the ability of the firms in an industry whose origin is in a particular country (e.g., South Korean automakers or Italian shoemakers) to be successful in the international arena is shaped by four factors: (1) their home country's demand conditions, (2) their home country's factor conditions, (3) related and supporting industries within their home country, and (4) strategy, structure, and rivalry among their domestic competitors.

Demand Conditions

Within the diamond model, **demand conditions** refer to the nature of domestic customers (Table 7.6 "Demand Conditions"). It is tempting to believe that firms benefit when their domestic customers are perfectly willing to purchase inferior products. This would be a faulty belief! Instead, firms benefit when their domestic customers have *high* expectations.

Japanese consumers are known for insisting on very high levels of quality, aesthetics, and reliability. Japanese automakers such as Honda, Toyota, and Nissan reap rewards from this situation. These firms have to work hard to satisfy their domestic buyers. Living up to lofty quality standards at home prepares these firms to offer high-quality products when competing in international markets. In contrast, French car buyers do not stand out as particularly fussy. It is probably not a coincidence that French automakers Renault and Peugeot have struggled to gain traction within the global auto industry.

Table 7.6 Demand Conditions

Within the diamond model, demand conditions refer to the nature of domestic customers. Below we provide examples from the worldwide auto industry that illustrate how domestic customers influence firms' ability to compete in the global arena.

Japanese consumers insist on very high levels of quality, aesthetics, and reliability. This forces Honda, Toyota, and Nissan to rise to a difficult challenge as well as preparing them to dominate internationally.

Because French car buyers are not particularly picky, Renault and Peugeot have not been forced to excel in their home market. Not surprisingly, they have struggled to gain traction within the global auto industry.

Germans place value on the concept of *fahrvergnügen*, which means “driving pleasure.” Customers around the globe experience driving pleasure when purchasing cars from BMW, Mercedes-Benz, Porsche, and Volkswagen.

The Italian fascination with styling is evident in luxury car brands such as Alfa Romeo, Ferrari, Lamborghini, and Maserati.

To many Americans, bigger is better. This attitude is captured in the Hummer. Originally developed for military use, the Hummer is about as far away from eco-friendly as a vehicle can get.

Demand conditions also help to explain why German automakers such as Porsche, Mercedes-Benz, and BMW create excellent luxury and high-performance vehicles. German consumers value superb engineering. While a car is simply a means of transportation in some cultures, Germans place value on the concept of *fahrvergnügen*, which means “driving pleasure.” Meanwhile, demand for fast cars is high in Germany because the country has built nearly eight thousand miles of superhighways known as autobahns. No speed limits for cars are enforced on more than half of the eight thousand miles. Many Germans enjoy driving at 150 miles per hour or more, and German automakers must build cars capable of safely reaching and maintaining such speeds. When these companies compete in the international arena, the engineering and performance of their vehicles stand out.



Japanese firms must deliver very high quality to meet the expectations of Japanese consumers.

Factor Conditions

Factor conditions refer to the nature of raw material and other inputs that firms need to create goods and services (Table 7.7 “Factor Conditions”). Examples include land, labor, capital markets, and infrastructure. Firms benefit when they have good access to factor conditions and face challenges when they do not. Companies based in the United States, for example, are able to draw on plentiful natural resources, a skilled labor force, highly developed transportation systems, and sophisticated capital markets to be successful. The dramatic growth of Chinese manufacturers in recent years has been fueled in part by the availability of cheap labor.

Table 7.7 Factor Conditions

The factor conditions in a country serve as the basic building blocks of doing business within the country. Below we provide examples of how important factor conditions have provided competitive advantages for firms based in certain different countries.

Land	Russia has the greatest land mass of any country in the world and it enjoys vast oil deposits. This abundance of natural resources has helped Russia’s petroleum industry become one of the largest in the world.
Labor	India is the seventh largest country in terms of land mass, but its population size is second only to China. Because India graduates more English speakers annually than the United States, it should come as no surprise that Indian firms have gained ground in the international arena within industries that rely on engineering and computer skills.
Capital	The capital market in the United States is one of the largest and most sophisticated in the world. This has helped American companies fund expansion and innovation over time, making them better prepared for international competition.
Entrepreneurial Ability	Entrepreneurial ability creates national wealth when entrepreneurs develop new innovations that support key industries. Denmark’s low start-up costs and high research and development spending have fueled success in industries such as pharmaceuticals and medical equipment.

In some cases, overcoming disadvantages in factor conditions leads companies to develop unique skills. Japan is a relatively small island nation with little room to spare. This situation has led Japanese firms to be pioneers in the efficient use of warehouse space through systems such as **just-in-time inventory management (JIT)**. Rather than storing large amounts of parts and material, JIT management conserves space—and lowers costs—by requiring inputs to a production process to arrive at the moment they are needed. Their use of JIT management has given Japanese manufacturers an advantage when they compete in international markets.



American furniture makers benefit from the abundance of high-quality lumber in the United States.

Francis Eatherington – [Seneca Lumber spraying herbicides](#) – CC BY-NC 2.0.

Related and Supporting Industries

Table 7.8 Related and Supporting Industries

The Beatles’ legendary songwriting team of Lennon and McCartney once wrote that they got by “with a little help from my friends.” In Porter’s diamond model, the presence of strong friends in the form of related and supporting industries is one of the keys to national advantage. We provide examples of American industries that excel internationally due in part to help form supporting industries.

A very strong agriculture business helps support the cattle industry—which accounted for approximately four billion dollars worth of exports in 2010.

The same competitive spirit that arises within intramural and varsity sports at the collegiate level fuels the financial services sector and other American industries.

Excellent steel makers and engine manufacturers support the production of one of America’s most lucrative exports—commercial aircraft.

The pharmaceutical industry benefits from the research skills possessed by university-affiliated hospitals.

America’s excellent performing arts schools such as the Juilliard School cultivate the talents of world-famous American performers.

Could Italian shoemakers create some of the world’s best shoes if Italian leather makers were not among the world’s best? Possibly, but it would be much more difficult. The concept of [related and supporting industries](#) refers to the extent to which firms’ domestic suppliers and other complementary industries are developed and helpful (Table 7.8 “[Related and Supporting Industries](#)”). Italian shoemakers such as Salvatore Ferragamo, Prada, Gucci, and Versace benefit from

the availability of top-quality leather within their home country. If these shoemakers needed to rely on imported leather, they would lose flexibility and speed.



Fine Italian shoes, such as those found at the famous Via Montenapoleone in Milan, are usually made of fine Italian leather.

[Wikimedia Commons](#) – CC BY-SA 3.0.

The auto industry is a setting where related and supporting industries are very important. Electronics are key components of modern vehicles. South Korean automakers Kia and Hyundai can leverage the excellent electronics provided by South Korean firms Samsung and LG. Similarly, Honda, Nissan, and Toyota are able to draw on the skills of Sony and other Japanese electronics firms. Unfortunately, for French automakers Renault and Peugeot, no French electronics firms are standouts in the international arena. This situation makes it difficult for Renault and Peugeot to integrate electronics into their vehicles as effectively as their South Korean and Japanese rivals.

In extreme cases, the poor condition of related and supporting industries can undermine an operation. Otabo LLC, a small custom shoe company, was forced to shut down its Florida factory in 2008. Otabo struggled to find technicians that had the skills needed to fix its shoemaking machines. Meanwhile, there are very few suppliers of shoelaces, soles, eyelets, and other components in the United States because about 99 percent of the shoes purchased in the United States are imported, mostly from China. The few available suppliers were unwilling to create the small batches of customized materials that Otabo wanted. In the end, the American factory simply could not get access to many of the supplies needed to create shoes (Aepfel, 2008). Production was shifted to China, where all the needed supplies can be found easily and cheaply.

Firm Strategy, Structure, and Rivalry

Table 7.9 Strategy, Structure, and Rivalry

The concept of firm strategy, structure, and rivalry within the diamond model refers to how challenging it is to survive

domestic competition. When domestic competition is fierce, the survivors are well prepared for the international arena. Below we offer examples of some of the most renowned exports that have resulted from the intense competition in domestic markets.

<p>Cuban cigar brands such as Chiba are treasured by cigar aficionados around the globe. Despite U.S. trade sanctions, cigars remain a leading export from Cuba.</p>	<p>Over one million weavers work in Iran’s Persian rug industry. Part of the magic behind these world-famous carpets is that excellence is needed in order to fly above a crowded domestic market.</p>
<p>Belgian firms produce over 200 million tons of chocolate each year. Brands that prosper despite this domestic competition stand out when they compete overseas.</p>	<p>German breweries produce over five thousand brands of beer. With this high level of domestic rivalry, it is not surprising that German beers excel worldwide.</p>
<p>Say “domo arigato” (Thank you very much) to the Japanese electronics industry, where competitors Seiko, Sony, Hitachi, and others push each other to bring smiles to the faces of consumers wanting a new watch, camera, video game system, or robot.</p>	<p>U.S. movie studios have collectively dominated the global scene since the days of Charlie Chaplin and other silent-film stars.</p>

The concept of **firm strategy, structure, and rivalry** refers to how challenging it is to survive domestic competition (Table 7.9 “Strategy, Structure, and Rivalry”). The Olympics offer a good analogy for illustrating the positive aspects of very challenging domestic situations. If the competition to make a national team in gymnastics is fierce, the gymnasts who make the team will have been pushed to stretch their abilities and performance. In contrast, gymnasts who faced few contenders in their quest to make a national team will not have been tested with the same level of intensity. When the two types meet at the Olympics, the gymnasts who overcame huge hurdles to make their national teams are likely to have an edge over athletes from countries with few skilled gymnasts.

Companies that have survived intense rivalry within their home markets are likely to have developed strategies and structures that will facilitate their success when they compete in international markets. Hyundai and Kia had to keep pace with each other within the South Korean market before expanding overseas. The leading Japanese automakers—Honda, Nissan, and Toyota—have had to compete not only with one another but also with smaller yet still potent domestic firms such as Isuzu, Mazda, Mitsubishi, Subaru, and Suzuki. In both examples, the need to navigate potent domestic rivals has helped firms later become fearsome international players.



Succeeding despite difficult domestic competition prepares firms to expand their kingdoms into international markets.

[Wikimedia Commons](#) – CC BY-SA 3.0.

If, in contrast, domestic competition is fairly light, a company may enjoy admirable profits within its home market. However, the lack of being pushed by rivals will likely mean that the firm struggles to reach its potential in creativity and innovation. This undermines the firm's ability to compete overseas and makes it vulnerable to foreign entry into its home market. Because neither Renault nor Peugeot has been a remarkable innovator historically, these French automakers have enjoyed fairly gentle domestic competition. Once the auto industry became a global competition, however, these firms found themselves trailing their Asian rivals.

Key Takeaway

- The likelihood that a firm will succeed when it competes in international markets is shaped by four aspects of its domestic market: (1) demand conditions; (2) factor conditions; (3) related and supporting industries; and (4) strategy, structure, and rivalry among its domestic competitors.

Exercises

1. Which of the four elements of the diamond model do you believe has the strongest influence on a firm's fate when it competes in international markets?
2. Automakers in China and India have yet to compete on the world stage. Based on the diamond model, would these firms be likely to succeed or fail within the global auto industry?

References

- Aepfel, T. 2008, March 3. US shoe factory finds supplies are Achilles' heel. *Wall Street Journal*. Retrieved from <http://online.wsj.com/article/SB120450124543206313.html>.
- Friedman, T. L. 2005. *The world is flat: A brief history of the 21st century*. New York, NY: Farrar, Straus and Giroux.
- Porter, M. E. 1990. *The competitive advantage of nations*, New York, NY: Free Press.

7.4 Types of International Strategies

Learning Objectives

1. Understand what a multidomestic strategy involves and be able to offer an example.
2. Understand what a global strategy involves and be able to offer an example.
3. Understand what a transnational strategy involves and be able to offer an example.

A firm that has operations in more than one country is known as a **multinational corporation (MNC)**. The largest MNCs are major players within the international arena. Walmart's annual worldwide sales, for example, are larger than the dollar value of the entire economies of Austria, Norway, and Saudi Arabia. Although Walmart tends to be viewed as an American retailer, the firm earns more than one-quarter of its revenues outside the United States. Walmart owns significant numbers of stores in Mexico (1,730 as of mid-2011), Central America (549), Brazil (479), Japan (414), the United Kingdom (385), Canada (325), Chile (279), and Argentina (63). Walmart also participates in joint ventures in China (328 stores) and India (5).¹ Even more modestly sized MNCs are still very powerful. If Kia were a country, its current sales level of approximately \$21 billion would place it in the top 100 among the more than 180 nations in the world.

Multinationals such as Kia and Walmart must choose an international strategy to guide their efforts in various countries. There are three main international strategies available: (1) multidomestic, (2) global, and (3) transnational (Table 7.10 "International Strategy"). Each strategy involves a different approach to trying to build efficiency across nations and trying to be responsiveness to variation in customer preferences and market conditions across nations.

Multidomestic Strategy

A firm using a **multidomestic strategy** sacrifices efficiency in favor of emphasizing responsiveness to local requirements within each of its markets. Rather than trying to force all of its American-made shows on viewers around the globe, MTV customizes the programming that is shown on its channels within dozens of countries, including New Zealand, Portugal, Pakistan, and India. Similarly, food company H. J. Heinz adapts its products to match local preferences. Because some Indians will not eat garlic and onion, for example, Heinz offers them a version of its signature ketchup that does not include these two ingredients.

Table 7.10 International Strategy

“What’s for dinner?” is a question of interest to folks of all nations. The answer depends, in some part, on the international strategy of the corporations that provide foods, drinks, and condiments worldwide. Firms choose between the potential trade-offs between efficiency in production/distribution and responsiveness to local market preferences. Below we provide examples of how a firm’s decision may provide some answers to how you might fill your belly.



Kenny_lex – [Tabasco](#) – CC BY 2.0; Pete – [Project 365 #138: 180509 Ooooooh, cheeky!](#) – public domain; Ged Carroll – [Kit-Kat new](#) – CC BY 2.0; Creative Tools – [CreativeTools.se](#) – [PackshotCreator](#) – [Heinz Chili Sauce](#) – CC BY 2.0; Windell Oskay – [HP Sauce – 2](#) – CC BY 2.0; Andrew Maiman – [Green Tea Kit-Kat \(from Japan\)](#) – CC BY 2.0; Bodo – [Butterfinger](#) – CC BY 2.0.



Baked beans flavored with curry? This H. J. Heinz product is very popular in the United Kingdom.

[Wikimedia Commons](#) – CC BY-SA 3.0.

Global Strategy

A firm using a [global strategy](#) sacrifices responsiveness to local requirements within each of its markets in favor of emphasizing efficiency. This strategy is the complete opposite of a multidomestic strategy. Some minor modifications to products and services may be made in various markets, but a global strategy stresses the need to gain economies of scale by offering essentially the same products or services in each market.

Microsoft, for example, offers the same software programs around the world but adjusts the programs to match local languages. Similarly, consumer goods maker Procter & Gamble attempts to gain efficiency by creating global brands whenever possible. Global strategies also can be very effective for firms whose product or service is largely hidden from the customer's view, such as silicon chip maker Intel. For such firms, variance in local preferences is not very important.

Transnational Strategy

A firm using a [transnational strategy](#) seeks a middle ground between a multidomestic strategy and a global strategy. Such a firm tries to balance the desire for efficiency with the need to adjust to local preferences within various countries. For example, large fast-food chains such as McDonald's and Kentucky Fried Chicken (KFC) rely on the same brand names and the same core menu items around the world. These firms make some concessions to local tastes too. In France, for example, wine can be purchased at McDonald's. This approach makes sense for McDonald's because wine is a central element of French diets.

Key Takeaway

- Multinational corporations choose from among three basic international strategies: (1) multidomestic, (2) global, and (3) transnational. These strategies vary in their emphasis on achieving efficiency around the world and responding to local needs.

Exercises

1. Which of the three international strategies is Kia using? Is this the best strategy for Kia to be using?
2. Identify examples of companies using each of the three international strategies other than those described above. Which company do you think is best positioned to compete in international markets?

¹Standard & Poor's stock report on Walmart.

7.5 Options for Competing in International Markets

Learning Objectives

1. Understand the various options for entering an international market.
2. Be able to provide an example of a firm using each option.

Table 7.11 Market Entry Options

French philosopher Michel de Montaigne once quipped that marriage is “a market which has nothing free but the entrance.” When trying to match their goods and services with the promise of love from a new market, executives have multiple entry options—but they should carefully consider each, lest the romance be short-lived.

Exporting involved creating goods at home and then shipping them to another country. Civilian aircraft is a top-ten U.S. export to countries such as Japan, China, Germany, Italy, and France that want to make their skies friendlier for travel.

A **wholly owned subsidiary** is a business operation in a foreign country that a firm fully owns. Intel established IPLS—a wholly owned subsidiary in Ireland—to facilitate and manage its research throughout the “Emerald Isle.”

Franchising involves “renting” a firm’s brand name and business processes to local entrepreneurs. Curves International has used franchising to bulk up its fitness empire to include over sixty countries.

Licensing involves granting a foreign company the right to create a company’s product in exchange for a fee. This option is frequently used in manufacturing industries, such as when Coca-Cola licenses their secret formulas to local bottlers (without revealing the formulas, of course).

In a **joint venture**, two or more organizations each contribute to the creation of a new entity. In a **strategic alliance**, firms work together cooperatively without forming a new organization. Global Nuclear Fuel Co.—a collaboration among General Electric, Toshiba Corporation, and Hitachi Limited—is an example of a joint venture.

When the executives in charge of a firm decide to enter a new country, they must decide how to enter the country. There are five basic options available: (1) exporting, (2) creating a wholly owned subsidiary, (3) franchising, (4) licensing, and (5) creating a joint venture or strategic alliance (Table 7.11 “Market Entry Options”). These options vary in terms of how much control a firm has over its operation, how much risk is involved, and what share of the operation’s profits the firm gets to keep.

Exporting

Exporting involves creating goods within a firm's home country and then shipping them to another country. Once the goods reach foreign shores, the exporter's role is over. A local firm then sells the goods to local customers. Many firms that expand overseas start out as exporters because exporting offers a low-cost method to find out whether a firm's products are appealing to customers in other lands. Some Asian automakers, for example, first entered the US market through exporting. Small firms may rely on exporting because it is a low-cost option.



Exporting often relies on huge cargo ships, such as this one docked in Cyprus.

Marvia – [Cargo ship in channel](#) – CC BY-NC 2.0.

Once a firm's products are found to be viable in a particular country, exporting often becomes undesirable. A firm that exports its goods loses control of them once they are turned over to a local firm for sale locally. This local distributor may treat customers poorly and thereby damage the firm's brand. Also, an exporter only makes money when it sells its goods to a local firm, not when end users buy the goods. Executives may want their firm rather than a local distributor to enjoy the profits that are made when products are sold to individual customers.

Creating a Wholly Owned Subsidiary

A **wholly owned subsidiary** is a business operation in a foreign country that a firm fully owns. A firm can develop a wholly owned subsidiary through a **greenfield venture**, meaning that the firm creates the entire operation itself. Another possibility is purchasing an existing operation from a local company or another foreign operator.

Regardless of whether a firm builds a wholly owned subsidiary "from scratch" or acquires an existing operation, having a wholly owned subsidiary can be attractive because the firm maintains complete control over the operation and gets to keep all of the profits that the operation makes. A wholly owned subsidiary can be quite risky, however, because the firm must pay all of the expenses required to set it up and operate it. Kia, for example, spent \$1 billion to build its US

factory. Many firms are reluctant to spend such sums in more volatile countries because they fear that they may never recoup their investments.

Franchising

Table 7.12 Franchising: A Leading American Export

Franchising is a popular way for firms to grow internationally. Below we provide examples of US-based franchises that are successful worldwide.

In many Asian countries, McDonald's franchises offer side dishes such as rice alongside its signature French fries.
If you grow tired of strudel while in Germany, remember that Dunkin' Donuts has over 2,500 stores in 30 countries outside of the United States.
Legend says that the first sandwich was created when John Montagu, the fourth Earl of Sandwich, ordered meat tucked between bread so he could play cards and eat at the same time. The sandwich remains popular in Europe, where Subway boasts over one thousand franchised restaurants.
All KFCs in Japan prominently feature a statue of KFC's founder Colonel Sanders.
If a franchised store in Norway was open during the age of the Vikings, its slogan may have been "Thank Asgard for 7-11."

Franchising has been used by many firms that compete in service industries to develop a worldwide presence (Table 7.12 "Franchising: A Leading American Export"). Subway, The UPS Store, and Hilton Hotels are just a few of the firms that have done so. Franchising involves an organization (called a franchisor) granting the right to use its brand name, products, and processes to other organizations (known as franchisees) in exchange for an up-front payment (a franchise fee) and a percentage of franchisees' revenues (a royalty fee).

Franchising is an attractive way to enter foreign markets because it requires little financial investment by the franchisor. Indeed, local franchisees must pay the vast majority of the expenses associated with getting their businesses up and running. On the downside, the decision to franchise means that a firm will get to enjoy only a small portion of the profits made under its brand name. Also, local franchisees may behave in ways that the franchisor does not approve. For example, Kentucky Fried Chicken (KFC) was angered by some of its franchisees in Asia when they started selling fish dishes without KFC's approval. It is often difficult to fix such problems because laws in many countries are stacked in favor of local businesses. Last, franchises are only successful if franchisees are provided with a simple and effective business model. Executives thus need to avoid expanding internationally through franchising until their formula has been perfected.



Firms should own a thoroughly proven business model before franchising in other countries.

Licensing

While franchising is an option within service industries, [licensing](#) is most frequently used in manufacturing industries. Licensing involves granting a foreign company the right to create a company's product within a foreign country in exchange for a fee. These relationships often center on patented technology. A firm that grants a license avoids absorbing a lot of costs, but its profits are limited to the fees that it collects from the local firm. The firm also loses some control over how its technology is used.

A historical example involving licensing illustrates how rapidly events can change within the international arena. By the time Japan surrendered to the United States and its Allies in 1945, World War II had crippled the country's industrial infrastructure. In response to this problem, Japanese firms imported a great deal of technology, especially from American firms. When the Korean War broke out in the early 1950s, the American military relied on Jeeps made in Japan using licensed technology. In just a few years, a mortal enemy had become a valuable ally.

Strategy at the Movies

Gung Ho

Can American workers survive under Japanese management? Although this sounds like the premise for a bad reality TV show, the question was a legitimate consideration for General Motors (GM) and Toyota in the early 1980s. GM was struggling at the time to compete with the inexpensive, reliable, and fuel-efficient cars produced by Japanese firms. Meanwhile, Toyota was worried that the US government would limit the number of foreign cars that could be imported. To address these issues, these companies worked together to reopen a defunct GM plant in Fremont, California, in 1984 that would manufacture both companies' automobiles in one facility. The plant had been the worst performer in the GM system; however, under Toyota's management, the New United Motor Manufacturing Incorporated (NUMMI) plant became the best factory associated with GM—using the same workers as before! Despite NUMMI's eventual success, the joint production plant experienced significant growing pains stemming from the cultural differences between Japanese managers and American workers.

The NUMMI story inspired the 1986 movie *Gung Ho* in which a closed automobile manufacturing plant in Hadleyville, Pennsylvania, was reopened by Japanese car company Assan Motors. While Assan Motors and the workers of Hadleyville were both excited about the venture, neither was prepared for the differences between the two cultures. For example, Japanese workers feel personally ashamed when they make a mistake. When manager Oishi Kazuhiro failed to meet production targets, he was punished with “ribbons of shame” and forced to apologize to his employees for letting them down. In contrast, American workers were presented in the film as likely to reject management authority, prone to fighting at work, and not opposed to taking shortcuts.

When Assan Motors' executives attempted to institute morning calisthenics and insisted that employees work late without overtime pay, the American workers challenged these policies and eventually walked off the production line. Assan Motors' near failure was the result of differences in cultural norms and values. *Gung Ho* illustrates the value of understanding and bridging cultural differences to facilitate successful cross-cultural collaboration, value that was realized in real life by NUMMI.



[Wikimedia Commons](#) – CC BY 2.5.

Joint Ventures and Strategic Alliances

Within each market entry option described earlier, a firm either maintains strong control of operations (wholly owned subsidiary) or it turns most control over to a local firm (exporting, franchising, and licensing). In some cases, however, executives find it beneficial to work closely with one or more local partners in a joint venture or a strategic alliance. In a joint venture, two or more organizations each contribute to the creation of a new entity. In a strategic alliance, firms work together cooperatively, but no new organization is formed. In both cases, the firm and its local partner or partners share decision-making authority, control of the operation, and any profits that the relationship creates.

Joint ventures and strategic alliances are especially attractive when a firm believes that working closely with locals will provide it important knowledge about local conditions, facilitate acceptance of their involvement by government officials, or both. In the late 1980s, China was a difficult market for American businesses to enter. Executives at KFC saw China as an attractive country because chicken is a key element of Chinese diets. After considering the various options for entering China with its first restaurant, KFC decided to create a joint venture with three local organizations. KFC owned 51 percent of the venture; having more than half of the operation was advantageous in case disagreements arose. A Chinese bank owned 25 percent, the local tourist bureau owned 14 percent, and the final 10 percent was owned by a local chicken producer that would supply the restaurant with its signature food item.

Having these three local partners helped KFC navigate the cumbersome regulatory process that was in place and allowed the American firm to withstand the scrutiny of wary Chinese officials. Despite these advantages, it still took more than a year for the store to be built and approved. Once open in 1987, however, KFC was an instant success in China. As China's economy gradually became more and more open, KFC was a major beneficiary. By the end of 1997, KFC operated 191 restaurants in 50 Chinese cities. By the start of 2011, there were approximately 3,200 KFCs

spread across 850 Chinese cities. Roughly 90 percent of these restaurants are wholly owned subsidiaries of KFC—a stark indication of how much doing business in China has changed over the past twenty-five years.



As of early 2011, KFC was opening a new store in China every eighteen hours on average.

[Wikimedia Commons](#) – CC BY-SA 3.0.

Key Takeaway

- When entering a new country, executives can choose exporting, creating a wholly owned subsidiary, franchising, licensing, and creating a joint venture or strategic alliance. The key issues of how much control a firm has over its operation, how much risk is involved, and what share of the operation's profits the firm gets to keep all vary across these options.

Exercises

1. Do you believe that KFC would have been so successful in China today if executives had tried to make their first store a wholly owned subsidiary? Why or why not?
2. The typical joint venture only lasts a few years. Why might joint ventures dissolve so quickly?

7.6 Conclusion

This chapter explains competition in international markets. Executives must consider the benefits and risks of competing internationally when making decisions about whether to expand overseas. Executives also need to determine the likelihood that their firms will succeed when they compete in international markets by examining demand conditions, factor conditions, related and supporting industries, and strategy, structure, and rivalry among its domestic competitors. When a firm does venture overseas, a decision must be made about whether its international strategy will be multidomestic, global, or transnational. Finally, when leading a firm to enter a new market, executives can choose to manage the operation via exporting, creating a wholly owned subsidiary, franchising, licensing, and creating a joint venture or strategic alliance.

Exercises

1. Divide your class into four or eight groups, depending on the size of the class. Each group should select a different industry. Find examples of each international strategy for your industry. Discuss which strategy seems to be the most successful in your selected industry.
2. This chapter discussed Kia and other automakers. If you were assigned to turn around a struggling automaker such as General Motors or Chrysler, what actions would you take to revive the company's prospects within the global auto industry?

Chapter 8: Selecting Corporate-Level Strategies

Chapter 8: Selecting Corporate-Level Strategies

8.1 Selecting Corporate-Level Strategies

8.2 Concentration Strategies

8.3 Vertical Integration Strategies

8.4 Diversification Strategies

8.5 Strategies for Getting Smaller

8.6 Portfolio Planning and Corporate-Level Strategy

8.7 Conclusion

8.1 Selecting Corporate-Level Strategies

Learning Objectives

After reading this chapter, you should be able to understand and articulate answers to the following questions:

1. Why might a firm concentrate on a single industry?
2. What is vertical integration and what benefits can it provide?
3. What are the two types of diversification and when should they be used?
4. Why and how might a firm retrench or restructure?
5. What is portfolio planning and why is it useful?

What's the Big Picture at Disney?



Walt Disney remains a worldwide icon five decades after his death.

[Wikimedia Commons](#) – public domain.

The animated film *Cars 2* was released by Pixar Animation Studios in late June 2011. This sequel to the smash hit *Cars* made \$66 million at the box office on its opening weekend and appeared likely to be yet another commercial success for Pixar's parent corporation, The Walt Disney Company. By the second weekend after its release, *Cars 2* had raked in \$109 million.

Although Walt Disney was a visionary, even he would have struggled to imagine such enormous numbers when his company was created. In 1923, Disney Brothers Cartoon Studio was started by Walt and his brother Roy in their uncle's garage. The fledgling company gained momentum in 1928 when a character was invented that still plays a central role for Disney today—Mickey Mouse. Disney expanded beyond short cartoons to make its first feature film, *Snow White and the Seven Dwarves*, in 1937.

Following a string of legendary films such as *Pinocchio* (1940), *Fantasia* (1940), *Bambi* (1942), and *Cinderella* (1950), Walt Disney began to diversify his empire. His company developed a television series for the American Broadcasting Company (ABC) in 1954 and opened the Disneyland theme park in 1955. Shortly before its opening, the theme park was featured on the television show to expose the American public to Walt's innovative ideas. One of the hosts of that episode was Ronald Reagan, who twenty-five years later became president of the United States. A larger theme park, Walt Disney World, was opened in Orlando in 1971. Roy Disney died just two months after Disney World opened; his brother Walt had passed in 1966 while planning the creation of the Orlando facility.

The Walt Disney Company began a series of acquisitions in 1993 with the purchase of movie studio Miramax Pictures. ABC was acquired in 1996, along with its very successful sports broadcasting company, ESPN. Two other important acquisitions were made during the following decade. Pixar Studios was purchased in 2006 for \$7.4 billion. This strategic move brought a very creative and successful animation company under Disney's control. Three years later, Marvel Entertainment was acquired for \$4.24 billion. Marvel was attractive because of its vast roster of popular characters, including Iron Man, the X-Men, the Incredible Hulk, the Fantastic Four, and Captain America. In addition to featuring these characters in movies, Disney could build attractions around them within its theme parks.

With annual revenues in excess of \$38 billion, The Walt Disney Company was the largest media conglomerate in the world by 2010. It was active in four key industries. Disney's theme parks included not only its American locations but also joint ventures in France and Hong Kong. A park in Shanghai, China, is slated to open by 2016. The theme park business accounted for 28 percent of Disney's revenues.

Disney's presence in the television industry, including ABC, ESPN, Disney Channel, and ten television stations, accounted for 45 percent of revenues. Disney's original business, filmed entertainment, accounted for 18 percent of revenue. Merchandise licensing was responsible for 7 percent of revenue. This segment of the business included children's books, video games, and 350 stores spread across North American, Europe, and Japan. The remaining 2 percent of revenues were derived from interactive online technologies. Much of this revenue was derived from Playdom, an online gaming company that Disney acquired in 2010.¹

By mid-2011, questions arose about how Disney was managing one of its most visible subsidiaries. Pixar's enormous success had been built on creativity and risk taking. Pixar executives were justifiably proud that they made successful movies that most studios would view as quirky and too off-the-wall. A good example is 2009's *Up!*, which made \$730 million despite having unusual main characters: a grouchy widower, a misfit "Wilderness Explorer" in search of a merit badge for helping the elderly, and a talking dog. Disney executives, however, seemed to be adopting a much different approach to moviemaking. In a February 2011 speech, Disney's chief financial officer noted that Disney intended to emphasize movie franchises such as *Toy Story* and *Cars* that can support sequels and sell merchandise.

When the reviews of Pixar's *Cars 2* came out in June, it seemed that Disney's preferences were the driving force behind the movie. The film was making money, but it lacked Pixar's trademark artistry. One movie critic noted, "With *Cars 2*, Pixar goes somewhere new: the ditch." Another suggested that "this frenzied sequel seldom gets beyond mediocrity." A stock analyst that follows Disney perhaps summed up the situation best when he suggested that *Cars 2* was "the worst-case scenario...A movie created solely to drive merchandise. It feels cynical. Parents may feel they're watching a two-hour commercial (Stewart, 2011)." Looking to the future, Pixar executives had to wonder whether their studio could excel as part of a huge firm. Would Disney's financial emphasis destroy the creativity that made Pixar worth more than \$7 billion in the first place? The big picture was definitely unclear.



Will John Lassiter, Pixar's chief creative officer, be prevented from making more quirky films like *Up!* by parent company Disney?

[Wikimedia Commons](#) – CC BY-SA 2.0.

When dealing with corporate-level strategy, executives seek answers to a key question: In what industry or industries should our firm compete? The executives in charge of a firm such as The Walt Disney Company must decide whether to remain within their present domains or venture into new ones. In Disney's case, the firm has expanded from its original business (films) and into television, theme parks, and several others. In contrast, many firms never expand beyond their initial choice of industry.

¹Standard & Poor's stock report on The Walt Disney Company.

References

Stewart, J. B. 2011, June 1. A collision of creativity and cash. *New York Times*. Retrieved from <http://www.nytimes.com/2011/07/02/business/02stewart.html>.

8.2 Concentration Strategies

Learning Objectives

1. Name and understand the three concentration strategies.
2. Be able to explain horizontal integration and two reasons why it often fails.

For many firms, [concentration strategies](#) are very sensible. These strategies involve trying to compete successfully only within a single industry. McDonald's, Starbucks, and Subway are three firms that have relied heavily on concentration strategies to become dominant players.

Table 8.1 Concentration Strategies

Concentration strategies involve trying to grow by successfully competing only within a single industry. WE illustrate the three concentration strategies below.

Market penetration involves trying to gain additional share of a firm's existing markets using existing products—often by relying on extensive advertising. Perhaps the most famous example of two close rivals simultaneously attempting market penetration is the “cola wars” where Coca-Cola and PepsiCo fight for share in the soft drink market. Pepsi's blind taste tests in 1975 called the Pepsi Challenge is one of the more famous attacks in this ongoing battle.

Market development involves taking existing products and trying to sell them within new markets. Starbucks engages in market development by selling their beans and bottled drinks in grocery stores. Apple engages in market development by allowing customers in Starbucks stores to connect directly to iTunes store and Starbucks Now Playing content. Customers are offered a free download to get them to visit iTunes—and to perhaps purchase more songs.

Product development involves creating new products to serve existing markets. King Gillette, an American businessman whose family hailed from France, pioneered the safety razor that bears his family name. His company's more recent innovations in the razor market include Trac II (the first two-blade razor), Altra (first razor with a pivoting head), Sensor (first razor with spring-loaded blades), Mach 3 (first three-blade razor), and Fusion (first six-blade razor). Is the ten-blade razor coming soon?

Market Penetration

There are three concentration strategies: (1) market penetration, (2) market development, and (3) product development ([Table 8.1 “Concentration Strategies”](#)). A firm can use one, two, or all three as part of their efforts to excel within an

industry (Ansoff, 1957). **Market penetration** involves trying to gain additional share of a firm's existing markets using existing products. Often firms will rely on advertising to attract new customers with existing markets.

Nike, for example, features famous athletes in print and television ads designed to take market share within the athletic shoes business from Adidas and other rivals. McDonald's has pursued market penetration in recent years by using Latino themes within some of its advertising. The firm also maintains a Spanish-language website at <http://www.meencanta.com>; the website's name is the Spanish translation of McDonald's slogan "I'm lovin' it." McDonald's hopes to gain more Latino customers through initiatives such as this website.



Nike relies in part on a market penetration strategy within the athletic shoe business.

Jean-louis Zimmermann – Nike, panneau d'affichage – CC BY 2.0.

Market Development

Market development involves taking existing products and trying to sell them within new markets. One way to reach a new market is to enter a new retail channel. Starbucks, for example, has stepped beyond selling coffee beans only in its stores and now sells beans in grocery stores. This enables Starbucks to reach consumers that do not visit its coffeehouses.



Starbucks' market development strategy has allowed fans to buy its beans in grocery stores.

[Wikimedia Commons](#) – CC BY 2.0.

Entering new geographic areas is another way to pursue market development. Philadelphia-based Tasty Baking Company has sold its Tastykake snack cakes since 1914 within Pennsylvania and adjoining states. The firm's products have become something of a cult hit among customers, who view the products as much tastier than the snack cakes offered by rivals such as Hostess and Little Debbie. In April 2011, Tastykake was purchased by Flowers Foods, a bakery firm based in Georgia. When it made this acquisition, Flower Foods announced its intention to begin extensively distributing Tastykake's products within the southeastern United States. Displaced Pennsylvanians in the south rejoiced.

Product Development

Product development involves creating new products to serve existing markets. In the 1940s, for example, Disney expanded its offerings within the film business by going beyond cartoons and creating movies featuring real actors. More recently, McDonald's has gradually moved more and more of its menu toward healthy items to appeal to customers who are concerned about nutrition.

In 2009, Starbucks introduced VIA, an instant coffee variety that executives hoped would appeal to their customers when they do not have easy access to a Starbucks store or a coffee pot. The soft drink industry is a frequent location of product development efforts. Coca-Cola and Pepsi regularly introduce new varieties—such as Coke Zero and Pepsi Cherry Vanilla—in an attempt to take market share from each other and from their smaller rivals.



Product development is a popular strategy in the soft-drink industry, but not all developments pay off. Coca-Cola Black (a blending of cola and coffee flavors) was launched in 2006 but discontinued in 2008.

Buglugs – [Coca-Cola Blak 4pack](#) – CC BY-SA 2.0.

Seattle-based Jones Soda Co. takes a novel approach to product development. Each winter, the firm introduces a holiday-themed set of unusual flavors. Jones Soda's 2006 set focus on the flavors of Thanksgiving. It contained Green Pea, Sweet Potato, Dinner Roll, Turkey and Gravy, and Antacid sodas. The flavors of Christmas were the focus of 2007's set, which included Sugar Plum, Christmas Tree, Egg Nog, and Christmas Ham. In early 2011, Jones Soda let its customers choose the winter 2011 flavors via a poll on its website. The winners were Candy Cane, Gingerbread, Pear Tree, and Egg Nog. None of these holiday flavors are expected to be big hits, of course. The hope is that the buzz that surrounds the unusual flavors each year will grab customers' attention and get them to try—and become hooked on—Jones Soda's more traditional flavors.

Horizontal Integration: Mergers and Acquisitions

Table 8.2 Horizontal Integration

*Horizontal integrations refers to pursuing a concentration strategy by acquiring or merging with a rival. The term **merger** is generally used when two similarly sized firms are integrated into a single entity. In an acquisition, a larger firm purchases and absorbs a smaller firm. We illustrate examples of each below.*

ExxonMobil is a direct descendant of John D. Rockefeller's Standard Oil Company. It was formed by the 1999 merger of Exxon and Mobil. As in many mergers, the new company name combines the old company names.

Starbucks acquired competitor Seattle's Best Coffee—which had a presence in Borders Bookstores and Subway Restaurants—in order to target a more working-class audience without diluting the Starbucks brand.

Bill Hewlett and Dave Packard formed Hewlett-Packard in a garage after graduating from Stanford in 1935. In recent years, HP has pursued horizontal integration through a merger with Compaq and the acquisition of Palm.

DaimlerChrysler was formed in 1998 when Chrysler entered into what was billed as a “merger of equals” with Germany's Daimler-Benz AG. The marriage failed, and Chrysler is currently owned by Italian automaker Fiat.

Global pharmaceutical firm GlaxoSmithKline plc was formed by the merger of GlaxoWellcome plc and SmithKline Beecham plc in 200.

Rather than rely on their own efforts, some firms try to expand their presence in an industry by acquiring or merging with one of their rivals. This strategic move is known as **horizontal integration** (Table 8.2 “Horizontal Integration”). An **acquisition** takes place when one company purchases another company. Generally, the acquired company is smaller than the firm that purchases it. A **merger** joins two companies into one. Mergers typically involve similarly sized companies. Disney was much bigger than Miramax and Pixar when it joined with these firms in 1993 and 2006, respectively, thus these two horizontal integration moves are considered to be acquisitions.

Horizontal integration can be attractive for several reasons. In many cases, horizontal integration is aimed at lowering costs by achieving greater economies of scale. This was the reasoning behind several mergers of large oil companies, including BP and Amoco in 1998, Exxon and Mobil in 1999, and Chevron and Texaco in 2001. Oil exploration and refining is expensive. Executives in charge of each of these six corporations believed that greater efficiency could be achieved by combining forces with a former rival. Considering horizontal integration alongside Porter's five forces model highlights that such moves also reduce the intensity of rivalry in an industry and thereby make the industry more profitable.

Some purchased firms are attractive because they own strategic resources such as valuable brand names. Acquiring Tasty Baking was appealing to Flowers Foods, for example, because the name Tastykake is well known for quality in heavily populated areas of the northeastern United States. Some purchased firms have market share that is attractive.

Part of the motivation behind Southwest Airlines' purchase of AirTran was that AirTran had a significant share of the airline business in cities—especially Atlanta, home of the world's busiest airport—that Southwest had not yet entered. Rather than build a presence from nothing in Atlanta, Southwest executives believed that buying a position was prudent.

Horizontal integration can also provide access to new distribution channels. Some observers were puzzled when Zuffa, the parent company of the Ultimate Fighting Championship (UFC), purchased rival mixed martial arts (MMA) promotion Strikeforce. UFC had such a dominant position within MMA that Strikeforce seemed to add very little for Zuffa. Unlike UFC, Strikeforce had gained exposure on network television through broadcasts on CBS and its partner Showtime. Thus acquiring Strikeforce might help Zuffa gain mainstream exposure of its product (Wagenheim, 2011).

A promotional poster for a UFC fight. At the top, it reads "WORLD WELTERWEIGHT CHAMPIONSHIP" in white serif font. Below that, the "UFC" logo is prominently displayed in white. The central image shows two fighters, Sumalino and Valdez, in a boxing stance, facing each other with their fists raised. The background is dark, and the fighters are lit from the side. Below the fighters, the names "SUMALINO" and "VALDEZ" are written in large, bold, black serif font, separated by "VS" in a smaller font. Below the names, the date "SATURDAY. 4. 24. 2010" is written in a large, bold, white sans-serif font. Underneath the date, "MGM GRAND, LAS VEGAS" and "LIVE ON PAY-PER-VIEW" are written in a smaller, white sans-serif font. At the bottom of the poster, there is a row of logos for Bud Light and Mang Tomas, alternating between the two brands.

The combination of UFC and Strikeforce into one company may accelerate the growing popularity of mixed martial arts.

Ben Ahhi – UFC POSTER-fire – CC BY 2.0.

Despite the potential benefits of mergers and acquisitions, their financial results often are very disappointing. One study found that more than 60 percent of mergers and acquisitions erode shareholder wealth while fewer than one in six increases shareholder wealth (Henry, 2002). Some of these moves struggle because the cultures of the two companies cannot be meshed. This chapter's opening vignette suggests that Disney and Pixar may be experiencing this problem. Other acquisitions fail because the buyer pays more for a target company than that company is worth and the buyer never earns back the premium it paid.

In the end, between 30 percent and 45 percent of mergers and acquisitions are undone, often at huge losses (Hitt, et. al., 2001). For example, Mattel purchased The Learning Company in 1999 for \$3.6 billion and sold it a year later for \$430 million—12 percent of the original purchase price. Similarly, Daimler-Benz bought Chrysler in 1998 for \$37 billion. When the acquisition was undone in 2007, Daimler recouped only \$1.5 billion worth of value—a mere 4 percent of what it paid. Thus executives need to be cautious when considering using horizontal integration.

Key Takeaways

- A concentration strategy involves trying to compete successfully within a single industry.
- Market penetration, market development, and product development are three methods to grow within an industry. Mergers and acquisitions are popular moves for executing a concentration strategy, but executives need to be cautious about horizontal integration because the results are often poor.

Exercises

1. Suppose the president of your college or university decided to merge with or acquire another school. What schools would be good candidates for this horizontal integration move? Would the move be a success?
2. Given that so many mergers and acquisitions fail, why do you think that executives keep making horizontal integration moves?
3. Can you identify a struggling company that could benefit from market penetration, market development, or product development? What might you advise this company's executives to do differently?

References

- Ansoff, H. I. 1957. Strategies for diversification. *Harvard Business Review*, 35(5), 113–124.
- Henry, D. 2002, October 14. Mergers: Why most big deals don't pay off. *Business Week*, 60–70.
- Hitt, M. A., Harrison, J. S., & Ireland, R. D. 2001. *Mergers and acquisitions: A guide to creating value for stakeholders*. New York, NY: Oxford University Press.
- Wagenheim, J. 2011, March 12. UFC buys out Strikeforce in another step toward global domination. *SI.com*.

Retrieved from http://sportsillustrated.cnn.com/2011/writers/jeff_wagenheim/03/12/strikeforce-purchased/index.html.

8.3 Vertical Integration Strategies

Learning Objectives

1. Understand what backward vertical integration is.
2. Understand what forward vertical integration is.
3. Be able to provide examples of backward and forward vertical integration.

When pursuing a [vertical integration](#) strategy, a firm gets involved in new portions of the value chain ([Table 8.3 “Vertical Integration at American Apparel”](#)). This approach can be very attractive when a firm’s suppliers or buyers have too much power over the firm and are becoming increasingly profitable at the firm’s expense. By entering the domain of a supplier or a buyer, executives can reduce or eliminate the leverage that the supplier or buyer has over the firm. Considering vertical integration alongside Porter’s five forces model highlights that such moves can create greater profit potential. Firms can pursue vertical integration on their own, such as when Apple opened stores bearing its brand, or through a merger or acquisition, such as when eBay purchased PayPal.

In the late 1800s, Carnegie Steel Company was a pioneer in the use of vertical integration. The firm controlled the iron mines that provided the key ingredient in steel, the coal mines that provided the fuel for steelmaking, the railroads that transported raw material to steel mills, and the steel mills themselves. Having control over all elements of the production process ensured the stability and quality of key inputs. By using vertical integration, Carnegie Steel achieved levels of efficiency never before seen in the steel industry.

Table 8.3 Vertical Integration at American Apparel

When using vertical integration, firms get involved in different elements of the value chain. This concept gets top billing at American Apparel, a firm that describes its business model as “vertically integrated manufacturing.” The elements of their integrated process for designing, manufacturing, wholesaling, and selling basic T-shirts, underwear, leggings, dresses, and other clothing and accessories for men, women, children, and dogs is illustrated below.

Backward vertical integration — entering a supplier’s business—is evident as all clothing design is done in-house—often using employees as models.

Manufacturing is conducted in a 800,000 square foot factory in downtown Los Angeles.

Ironically, it was a Canadian named Dov Charney who founded American Apparel in 1989.

The vertical integration process allows the company to keep pace with the fast-moving world of fashion. It takes just a couple of weeks to go from idea to retail floor.

American Apparel uses **forward vertical integration**—entering a buyer’s business—by operating 250 plus company-owned stores worldwide.

Today, oil companies are among the most vertically integrated firms. Firms such as ExxonMobil and ConocoPhillips can be involved in all stages of the value chain, including crude oil exploration, drilling for oil, shipping oil to refineries, refining crude oil into products such as gasoline, distributing fuel to gas stations, and operating gas stations.

The risk of not being vertically integrated is illustrated by the 2010 Deepwater Horizon oil spill in the Gulf of Mexico. Although the US government held BP responsible for the disaster, BP cast at least some of the blame on drilling rig owner Transocean and two other suppliers: Halliburton Energy Services (which created the cement casing for the rig on the ocean floor) and Cameron International Corporation (which had sold Transocean blowout prevention equipment that failed to prevent the disaster). In April 2011, BP sued these three firms for what it viewed as their roles in the oil spill.



The 2010 explosion of the Deepwater Horizon oil rig cost eleven lives and released nearly five million barrels of crude oil into the Gulf of Mexico.

[Wikimedia Commons](#) – public domain.

Vertical integration also creates risks. Venturing into new portions of the value chain can take a firm into very different businesses. A lumberyard that started building houses, for example, would find that the skills it developed in the lumber business have very limited value to home construction. Such a firm would be better off selling lumber to contractors.

Vertical integration can also create complacency. Consider, for example, a situation in which an aluminum company is purchased by a can company. People within the aluminum company may believe that they do not need to worry about doing a good job because the can company is guaranteed to use their products. Some companies try to avoid this problem by forcing their subsidiary to compete with outside suppliers, but this undermines the reason for purchasing the subsidiary in the first place.

Backward Vertical Integration

A [backward vertical integration](#) strategy involves a firm moving back along the value chain and entering a supplier's business. Some firms use this strategy when executives are concerned that a supplier has too much power over their firms. In the early days of the automobile business, Ford Motor Company created subsidiaries that provided key inputs to vehicles such as rubber, glass, and metal. This approach ensured that Ford would not be hurt by suppliers holding out for higher prices or providing materials of inferior quality.

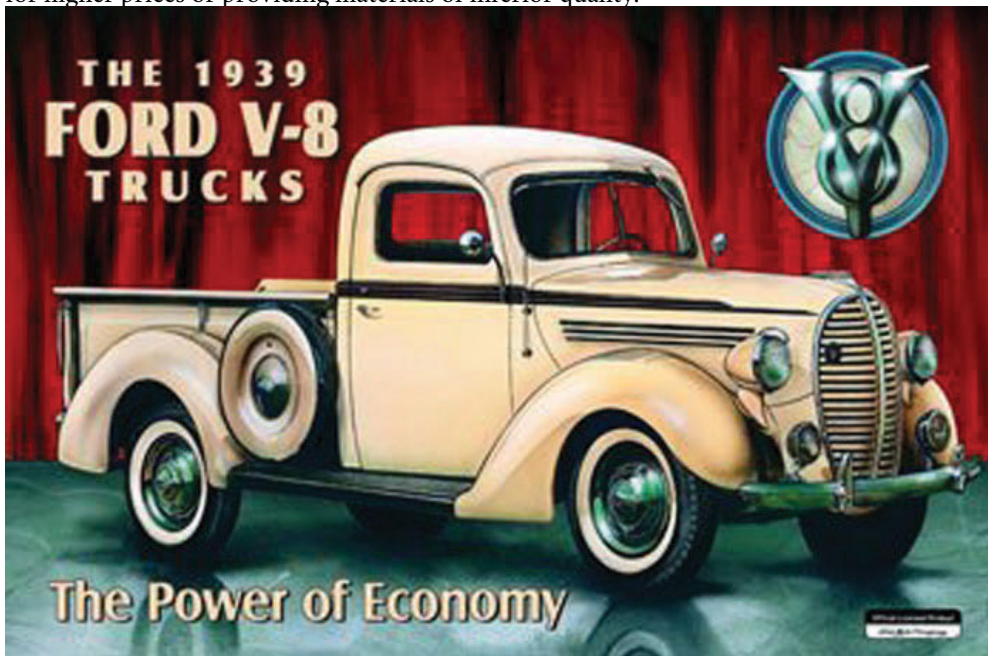

To ensure high quality, Ford relied heavily on backward vertical integration in the early days of the automobile industry.

[Wikimedia Commons](#) – public domain.

Although backward vertical integration is usually discussed within the context of manufacturing businesses, such as steelmaking and the auto industry, this strategy is also available to firms such as Disney that compete within the entertainment sector. ESPN is a key element of Disney's operations within the television business. Rather than

depend on outside production companies to provide talk shows and movies centered on sports, ESPN created its own production company. ESPN Films is a subsidiary of ESPN that was created in 2001. ESPN Films has created many of ESPN's best-known programs, including *Around the Horn* and *Pardon the Interruption*. By owning its own production company, ESPN can ensure that it has a steady flow of programs that meet its needs.

Forward Vertical Integration

A **forward vertical integration** strategy involves a firm moving further down the value chain to enter a buyer's business. Disney has pursued forward vertical integration by operating more than three hundred retail stores that sell merchandise based on Disney's characters and movies. This allows Disney to capture profits that would otherwise be enjoyed by another store. Each time a Hannah Montana book bag is sold through a Disney store, the firm makes a little more profit than it would if the same book bag were sold by a retailer such as Target.

Forward vertical integration also can be useful for neutralizing the effect of powerful buyers. Rental car agencies are able to insist on low prices for the vehicles they buy from automakers because they purchase thousands of cars. If one automaker stubbornly tries to charge high prices, a rental car agency can simply buy cars from a more accommodating automaker. It is perhaps not surprising that Ford purchased Hertz Corporation, the world's biggest rental car agency, in 1994. This ensured that Hertz would not drive too hard of a bargain when buying Ford vehicles. By 2005, selling vehicles to rental car companies had become less important to Ford and Ford was struggling financially. The firm then reversed its forward vertical integration strategy by selling Hertz.



The massive number of cars purchased by rental car agencies makes forward vertical integration a tempting strategy for automakers.

[Wikimedia Commons](#) – CC BY 3.0.

eBay's purchase of PayPal and Apple's creation of Apple Stores are two recent examples of forward vertical integration. Despite its enormous success, one concern for eBay is that many individuals avoid eBay because they are nervous about buying and selling goods online with strangers. PayPal addressed this problem by serving, in exchange for a fee, as an intermediary between online buyers and sellers. eBay's acquisition of PayPal signaled to potential customers

that their online transactions were completely safe—eBay was now not only the place where business took place but eBay also protected buyers and sellers from being ripped off.

Apple's ownership of its own branded stores set the firm apart from computer makers such as Hewlett-Packard, Acer, and Gateway that only distribute their products through retailers like Best Buy and Office Depot. Employees at Best Buy and Office Depot are likely to know just a little bit about each of the various brands their store carries.

In contrast, Apple's stores are popular in part because store employees are experts about Apple products. They can therefore provide customers with accurate and insightful advice about purchases and repairs. This is an important advantage that has been created through forward vertical integration.

Key Takeaway

- Vertical integration occurs when a firm gets involved in new portions of the value chain. By entering the domain of a supplier (backward vertical integration) or a buyer (forward vertical integration), executives can reduce or eliminate the leverage that the supplier or buyer has over the firm.

Exercises

1. Identify a well-known company that does not use backward or forward vertical integration. Why do you believe that the firm's executives have avoided these strategies?
2. Some universities have used vertical integration by creating their own publishing companies. The Harvard Business Press is perhaps the best-known example. Are there other ways that a university might vertical integrate? If so, what benefits might this create?

8.4 Diversification Strategies

Learning Objectives

1. Explain the concept of diversification.
2. Be able to apply the three tests for diversification.
3. Distinguish related and unrelated diversification.

Firms using [diversification strategies](#) enter entirely new industries. While vertical integration involves a firm moving into a new part of a value chain that it is already in, diversification requires moving into new value chains. Many firms accomplish this through a merger or an acquisition, while others expand into new industries without the involvement of another firm.

Three Tests for Diversification

A proposed diversification move should pass three tests or it should be rejected (Porter, 1987).

1. How attractive is the industry that a firm is considering entering? Unless the industry has strong profit potential, entering it may be very risky.
2. How much will it cost to enter the industry? Executives need to be sure that their firm can recoup the expenses that it absorbs in order to diversify. When Philip Morris bought 7Up in the late 1970s, it paid four times what 7Up was actually worth. Making up these costs proved to be impossible and 7Up was sold in 1986.
3. Will the new unit and the firm be better off? Unless one side or the other gains a competitive advantage, diversification should be avoided. In the case of Philip Morris and 7Up, for example, neither side benefited significantly from joining together.

Related Diversification

[Related diversification](#) occurs when a firm moves into a new industry that has important similarities with the firm's existing industry or industries (Figure 8.4 "The Sweet Fragrance of Success: The Brands That "Make Up" the Lauder Empire"). Because films and television are both aspects of entertainment, Disney's purchase of ABC is an example of related diversification. Some firms that engage in related diversification aim to develop and exploit a [core competency](#) to become more successful. A core competency is a skill set that is difficult for competitors to imitate, can be leveraged in different businesses, and contributes to the benefits enjoyed by customers within each business (Prahalad & Hamel, 1990). For example, Newell Rubbermaid is skilled at identifying underperforming brands and integrating them into their three business groups: (1) home and family, (2) office products, and (3) tools, hardware, and commercial products.

Figure 8.4 The Sweet Fragrance of Success: The Brands That "Make Up" the Lauder Empire

Estée Lauder was a pioneer in the cosmetics industry. Estée Lauder summarized her zest for business by noting, "I have never worked a day in my life without selling. If I believe in something, I sell it, and I sell it hard." The company that bears her name has used related diversification and other growth strategies to create over two dozen brands of cosmetics, perfume, skin care, and hair care products. Below we illustrate some of the products that make up the Lauder empire.



Prescriptives offers customizable cosmetics that provide an exact match to the customer's skin tone.



The Lauder empire includes a number of license agreements such as with Donna Karan's **DKNY** Be Delicious perfume.



Smashbox, acquired in 2010, is the cosmetics line of a premier photo studio founded by the great-grandsons of Hollywood cosmetics legend Max Factor.



Estée Lauder's **Sensuous** is one of the perfumes marketed under the Lauder name.



Bumble and bumble provides salon-quality shampoo, conditioner, and other hair care products.



Clinique was the first high-end allergy-tested, dermatologist-created cosmetics brand.



Bobbi Brown (namesake of the celebrated makeup artist) focuses on teaching women to be their own makeup artists.



M·A·C (Makeup Art Cosmetics) products were originally designed for professional makeup artists but are now available to consumers worldwide.

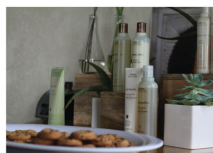

Aveda's line of high-end botanical spa products was acquired in 1997.



Joe Malone is a British lifestyle brand known for its unique fragrance portfolio.

Betsy Weber – [Aveda Suite – EVO Conference](#) – CC BY 2.0; ookikioo – [Bobi Brown Stonewashed Nudes Palette](#) – CC BY 2.0; Shortcuts Smarter Business Technology – [Studio DNA – Bumble and bumble](#) – CC BY 2.0; Joanne Saige Lee – [facial soap](#) – CC BY 2.0; Joanne Saige Lee – [‘even better’ skin tone corrector](#) – CC BY 2.0; Jessica Sheridan – [DKNY_060309_2514](#) – CC BY 2.0; David Fulmer – [Estee Lauder Sensuous](#) – CC BY 2.0; Mohmed Althani – [Jo Malone Perfume](#) – CC BY 2.0; Church Street Marketplace – [MAC Cosmetics](#) – CC BY 2.0; ookikioo – [Prescriptives Flawless Skin Concealer](#) – CC BY 2.0; porcupiny – [Tokidoki for Smashbox cosmetics](#) – CC BY 2.0.

Honda Motor Company provides a good example of leveraging a core competency through related diversification. Although Honda is best known for its cars and trucks, the company actually started out in the motorcycle business. Through competing in this business, Honda developed a unique ability to build small and reliable engines. When

executives decided to diversify into the automobile industry, Honda was successful in part because it leveraged this ability within its new business. Honda also applied its engine-building skills in the all-terrain vehicle, lawn mower, and boat motor industries.



Honda's related diversification strategy has taken the firm into several businesses, including boat motors.

[Wikimedia Commons](#) – public domain.

Sometimes the benefits of related diversification that executives hope to enjoy are never achieved. Both soft drinks and cigarettes are products that consumers do not need. Companies must convince consumers to buy these products through marketing activities such as branding and advertising. Thus, on the surface, the acquisition of 7Up by Philip Morris seemed to offer the potential for Philip Morris to take its existing marketing skills and apply them within a new industry. Unfortunately, the possible benefits to 7Up never materialized.

Unrelated Diversification

Table 8.5 Unrelated Diversification at Berkshire Hathaway

"Don't put all your eggs in one basket" is often a good motto for individual investors. By building a portfolio of stocks, an investor can minimize the chances of suffering a huge loss. Some executives take a similar approach. Rather than trying to develop synergy across businesses, they seek greater financial stability for their firms by owning an array of companies. Warren Buffett's Berkshire Hathaway has long enjoyed strong performance by purchasing companies and improving how they are run. Below we illustrate some of the different groups in their very diversified portfolio of firms.

Berkshire's insurance group includes firms such as General Re and GEICO. They maintain capital strength at exceptionally high levels, which gives them an advantage even a cave man could understand.	Berkshire's financial health is also fueled by utilities and energy companies that are part of the MidAmerican Energy Holdings Company.	Their apparel businesses include well-known names such as Fruit of the Loom and Justin Brands.
Building companies include Acme Building Brands, makes of the famous brick, as well as paint company Benjamin Moore & Co.	FlightSafety International Inc. is a Berkshire firm that engages in high-tech training to aircraft and ship operators.	Retail holdings include a number of furniture businesses such as R.C. Willey Home Furnishings, Star Furniture Company, and Jordan's Furniture, Inc.
Hungry for more businesses to manage, Berkshire acquired The Pampered Chef, Ltd.—the largest direct kitchen tools seller—in 2002.	Buffett had a sweet tooth for See's Candies, who he purchased from the See's family in 1972.	Shareholders were all on board for the purchase of the Burlington Northern Santa Fe Corporation in 2009.

Why would a soft-drink company buy a movie studio? It's hard to imagine the logic behind such a move, but Coca-Cola did just this when it purchased Columbia Pictures in 1982 for \$750 million. This is a good example of **unrelated diversification**, which occurs when a firm enters an industry that lacks any important similarities with the firm's existing industry or industries (Table 8.5 "Unrelated Diversification at Berkshire Hathaway"). Luckily for Coca-Cola, its investment paid off—Columbia was sold to Sony for \$3.4 billion just seven years later.

Most unrelated diversification efforts, however, do not have happy endings. Harley-Davidson, for example, once tried to sell Harley-branded bottled water. Starbucks tried to diversify into offering Starbucks-branded furniture. Both efforts were disasters. Although Harley-Davidson and Starbucks both enjoy iconic brands, these strategic resources simply did not transfer effectively to the bottled water and furniture businesses.

Lighter firm Zippo is currently trying to avoid this scenario. According to CEO Geoffrey Booth, the Zippo is viewed by consumers as a "rugged, durable, made in America, iconic" brand (Townhall, 2010). This brand has fueled eighty years of success for the firm. But the future of the lighter business is bleak. Zippo executives expect to sell about 12 million lighters this year, which is a 50 percent decline from Zippo's sales levels in the 1990s. This downward trend is likely to continue as smoking becomes less and less attractive in many countries. To save their company, Zippo executives want to diversify.



The durability of Zippo's products is illustrated by this lighter, which still works despite being made in 1968.

[Wikimedia Commons](#) – CC BY-SA 2.5.

In particular, Zippo wants to follow a path blazed by Eddie Bauer and Victorinox Swiss Army Brands Inc. The rugged outdoors image of Eddie Bauer's clothing brand has been used effectively to sell sport utility vehicles made by Ford. The high-quality image of Swiss Army knives has been used to sell Swiss Army-branded luggage and watches. As of March 2011, Zippo was examining a wide variety of markets where their brand could be leveraged, including watches, clothing, wallets, pens, liquor flasks, outdoor hand warmers, playing cards, gas grills, and cologne. Trying to figure out which of these diversification options would be winners, such as the Eddie Bauer-edition Ford Explorer, and which would be losers, such as Harley-branded bottled water, was a key challenge facing Zippo executives.

Strategy at the Movies

In Good Company

What do Techline cell phones, *Sports America* magazine, and Crispity Crunch cereals have in common? Not much, but that did not stop Globodyne from buying each of these companies in its quest for synergy in the

2004 movie *In Good Company*. Executive Carter Duryea was excited when his employer Globodyne purchased Waterman Publishing, the owner of *Sports America* magazine. The acquisition landed him a big promotion and increased his salary to “Porsche-leasing” size.

Synergy is created when two or more businesses produce benefits together that could not be produced separately. While Duryea was confident that a cross-promotional strategy between his advertising division and the other units within the Globodyne universe was a slam-dunk, Waterman employee Dan Foreman saw little congruence between advertisements in *Sports America* on the one hand and cell phones and breakfast cereals on the other. Despite his considerable efforts, Duryea was unable to increase ad pages in *Sports America* because the unrelated nature of Globodyne’s other business units inhibited his strategy of creating synergy. Seeing little value in owning a failing publishing company, Globodyne promptly sold the division to another conglomerate. After the sale, the executives that had been rewarded for the initial purchase of Waterman Publishing, including Duryea, were fired.

Globodyne’s inability to successfully manage Waterman Publishing illustrates the difficulties associated with unrelated diversification. While buying companies outside a parent company’s core competencies can increase the size of the company and in turn its executives’ bank accounts, managing firms unfamiliar to management is generally a risky and losing proposition. Decades of research on strategic management suggest that when firms diversify, it is best to “stick to the knitting.” That is, stay with businesses executives are familiar with and avoid moving into ventures where little expertise exists.



In Good Company starred Topher Grace as ill-fated junior executive Carter Duryea.

[Wikimedia Commons](#) – CC BY-SA 3.0.

Key Takeaway

- Diversification strategies involve firmly stepping beyond its existing industries and entering a new value chain. Generally, related diversification (entering a new industry that has important similarities with a firm's existing industries) is wiser than unrelated diversification (entering a new industry that lacks such similarities).

Exercises

1. Studies have shown that executives' pay increases when their firms gets larger. What role, if any, do you think executive pay plays in diversification decisions?
2. Identify a firm that has recently engaged in diversification. Search the firm's website to identify executives' rationale for diversifying. Do you find the reasoning to be convincing? Why or why not?

References

- Porter, M. E. 1987. From competitive advantage to corporate strategy. *Harvard Business Review*, 65(3), 102–121.
- Prahalad, C. K., & Hamel, G. 1990. The core competencies of the corporation. *Harvard Business Review*, 86(1), 79–91.
- Townhall, http://th2010.townhall.com/news/us/2011/03/20/zippos_burning_ambition_lies_in_retail_expansion.

8.5 Strategies for Getting Smaller

Learning Objectives

1. Understand why a firm would want to shrink or exit from a business.
2. Be able to distinguish retrenchment and restructuring.

“In what industry or industries should our firm compete?” is the central question addressed by corporate-level strategy. In some cases, the answer that executives arrive at involves exiting one or more industries.

Retrenchment

In the early twentieth century, many military battles were fought in series of parallel trenches. If an attacking army advanced enough to force a defending army to abandon a trench, the defenders would move back to the next trench and try to refortify their position. This small retreat was preferable to losing the battle entirely. Trench warfare inspired the business term **retrenchment**. Firms following a retrenchment strategy shrink one or more of their business units. Much like an army under attack, firms using this strategy hope to make just a small retreat rather than losing a battle for survival.

Retrenchment is often accomplished through laying off employees. In July 2011, for example, South African grocery store chain Pick n Pay announced plans to release more than 3,000 of its estimated 36,000 workers. Just over a month earlier, South African officials had approved Walmart’s acquisition of a leading local retailer called Massmart. Rivalry in the South African grocery business seemed likely to become fiercer, and Pick n Pay executives needed to cut costs for their firm to remain competitive.

A Pick n Pay executive explained the layoffs by noting that “the decision was not taken lightly but was required to ensure the viability of the retail business and its employees into the future (Chilwane, 2011).” This is a common rationale for retrenchment—by shrinking the size of a firm, executives hope that the firm can survive as a profitable enterprise. Without becoming smaller and more cost effective, Pick n Pay and other firms that use retrenchment can risk total failure.



The term *retrenchment* has its origins in trench warfare, which is shown in this World War I photo taken in France.

[Wikimedia Commons](#) – public domain.

Restructuring

Table 8.6 Spin Offs

Spin-offs occur when businesses create a new firm from a piece of their operations. Because some diversified firms are too complex for investors to understand, breaking them up can create wealth by resulting in greater stock market valuations. Spinning off a company also reduces management layers, which can lower costs and speed up decision making. Below we describe a variety of firms that were created as spin-offs.

There are 17 billion of Freescale Semiconductor's chips in use around the world. The firm was spun-off from Motorola in 2004.

Toyota started in the car business, right? Wrong. The firm was spun-off in the 1930s from Toyoda Automatic Loom Works—a company that produced commercial weaving looms.

The 2000 merger between America Online (AOL) and Time Warner was one of the largest in history. The firms split in 2009. Net result? A staggering \$99 billion loss.

Delphi Automotive—an automotive parts company headquartered in Troy, Michigan—is a spin-off from General Motors.

Guidant Corporation—a spin-off from Eli Lilly—designs and manufactures artificial pacemakers, defibrillators, stents, and other heart-helpful medical products.

Executives sometimes decide that bolder moves than retrenchment are needed for their firms to be successful in the future. **Divestment** refers to selling off part of a firm's operations. In some cases, divestment reverses a forward vertical integration strategy, such as when Ford sold Hertz. Divestment can also be used to reverse backward vertical integration. General Motors (GM), for example, turned a parts supplier called Delphi Automotive Systems Corporation from a GM subsidiary into an independent firm. This was done via a **spin-off**, which involves creating a new company whose stock is owned by investors (**Table 8.6 "Spin Offs"**). GM stockholders received 0.69893 shares of Delphi for every share of stock they owned in GM. A stockholder who owned 100 shares of GM received 69 shares of the new company plus a small cash payment in lieu of a fractional share.

Divestment also serves as a means to undo diversification strategies. Divestment can be especially appealing to executives in charge of firms that have engaged in unrelated diversification. Investors often struggle to understand the complexity of diversified firms, and this can result in relatively poor performance by the stocks of such firms. This is known as a **diversification discount**. Executives sometimes attempt to unlock hidden shareholder value by breaking up diversified companies.

Fortune Brands provides a good example. Surprisingly, this company does not own *Fortune* magazine, but it has been involved in a diverse set of industries. As of 2010, the firm consisted of three businesses: spirits (including Jim Beam and Maker's Mark), household goods (including Masterlock and Moen Faucets), and golf equipment (including Titleist clubs and balls as well as FootJoy shoes). In December 2010, Fortune Brand's CEO announced a plan to separate the three businesses to "maximize long-term value for our shareholders and to create exciting opportunities within our businesses (Sauerhaft, 2011)." Fortune Brands took the first step toward overcoming the diversification discount in May 2011 when it reached an agreement to sell its gold business to Fila. In June 2011, plans to **spin off** the home products business were announced.



Fortune Brands hopes to unlock hidden shareholder value by divesting unrelated brands such as Masterlock.

[Wikimedia Commons](#) – CC BY-SA 3.0.

Executives are sometimes forced to admit that the operations that they want to abandon have no value. If selling off part of a business is not possible, the best option may be **liquidation**. This involves simply shutting down portions of a firm’s operations, often at a tremendous financial loss. GM has done this by scrapping its Geo, Saturn, Oldsmobile, and Pontiac brands. Ford recently followed this approach by shutting down its Mercury brand. Such moves are painful because massive investments are written off, but becoming “leaner and meaner” may save a company from total ruin.

Key Takeaway

- Executives sometimes need to reduce the size of their firms to maximize the chances of success. This can involve fairly modest steps such as retrenchment or more profound restructuring strategies.

Exercises

1. Should Disney consider using retrenchment or restructuring? Why or why not?
2. Given how much information is readily available about companies, why do you think investors still struggle to analyze diversified companies?

References

Chilwane, L. 2011, July 7. Pick n Pay to retrench. *The New Age*. Retrieved from http://www.thenewage.co.za/22462-1025-53-Pick_n_Pay_to_retrench.

Sauerhaft, R. 2011, May 20. Fortune Brands to sell Titleist and FootJoy to Fila Korea. *Golf.com*. Retrieved from http://www.golf.com/golf/tours_news/article/0,28136,2073173,00.html#ixzz1MvXStp2b.

8.6 Portfolio Planning and Corporate-Level Strategy

Learning Objectives

1. Understand why a firm would want to use portfolio planning.
2. Be able to explain the limitations of portfolio planning.

Executives in charge of firms involved in many different businesses must figure out how to manage such portfolios. General Electric (GE), for example, competes in a very wide variety of industries, including financial services, insurance, television, theme parks, electricity generation, lightbulbs, robotics, medical equipment, railroad locomotives, and aircraft jet engines. When leading a company such as GE, executives must decide which units to grow, which ones to shrink, and which ones to abandon.

Portfolio planning can be a useful tool. Portfolio planning is a process that helps executives assess their firms' prospects for success within each of its industries, offers suggestions about what to do within each industry, and provides ideas for how to allocate resources across industries. Portfolio planning first gained widespread attention in the 1970s, and it remains a popular tool among executives today.

The Boston Consulting Group (BCG) Matrix

The Boston Consulting Group (BCG) matrix is the best-known approach to portfolio planning (Table 8.7 "The Boston Consulting Group (BCG) Matrix"). Using the matrix requires a firm's businesses to be categorized as high or low along two dimensions: its share of the market and the growth rate of its industry. High market share units within slow-growing industries are called **cash cows**. Because their industries have bleak prospects, profits from cash cows should not be invested back into cash cows but rather diverted to more promising businesses. Low market share units within slow-growing industries are called **dogs**. These units are good candidates for divestment. High market share units within fast-growing industries are called **stars**. These units have bright prospects and thus are good candidates for growth. Finally, low-market-share units within fast-growing industries are called **question marks**. Executives must decide whether to build these units into stars or to divest them.



Owning a puppy is fun, but companies may want to avoid owning units that are considered to be dogs.

Jonathan Kriz – [Puppy](#) – CC BY 2.0.

The BCG matrix is just one portfolio planning technique. With the help of a leading consulting firm, GE developed the attractiveness-strength matrix to examine its diverse activities. This planning approach involves rating each of a firm's businesses in terms of the attractiveness of the industry and the firm's strength within the industry. Each dimension is divided into three categories, resulting in nine boxes. Each of these boxes has a set of recommendations associated with it.

Table 8.7 The Boston Consulting Group (BCG) Matrix

The Boston Consulting Group (BCG) matrix is the best-known approach to portfolio planning—assessing a firm's prospects for success within the industries in which it competes. The matrix categorizes businesses as high or low along two dimensions—the firm's market share in each industry and the growth rate of each industry. Suggestions are then offered about how to approach each industry.

	High Relative Market Share	Low Relative Market Share
High Industry Growth Rate	Stars should be funded and encouraged to grow.	Question marks should be resolved by executives by deciding whether to foster or sell these units.
Low Industry Growth Rate	Cash cows should be "milked" to supply funds to more promising businesses.	It sounds mean, but dogs should be sold if possible and abandoned if necessary.

Limitations to Portfolio Planning

Although portfolio planning is a useful tool, this tool has important limitations. First, portfolio planning oversimplifies the reality of competition by focusing on just two dimensions when analyzing a company's operations within an industry. Many dimensions are important to consider when making strategic decisions, not just two. Second, portfolio planning can create motivational problems among employees. For example, if workers know that their firm's executives believe in the BCG matrix and that their subsidiary is classified as a dog, then they may give up any hope for the future. Similarly, workers within cash cow units could become dismayed once they realize that the profits that they help create will be diverted to boost other areas of the firm. Third, portfolio planning does not help identify new opportunities. Because this tool only deals with existing businesses, it cannot reveal what new industries a firm should consider entering.

Key Takeaway

- Portfolio planning is a useful tool for analyzing a firm's operations, but this tool has limitations. The BCG matrix is one of the most widely used approaches to portfolio planning.

Exercises

1. Is market share a good dimension to use when analyzing the prospects of a business? Why or why not?
2. What might executives do to keep employees within dog units motivated and focused on their jobs?

8.7 Conclusion

This chapter explains corporate-level strategy. Executives grappling with corporate-level strategy must decide in what industry or industries their firms will compete. Many of the possible answers to this question involve growth. Concentration strategies involve competing within existing domains to expand within those domains. This can take the form of market penetration, market development, or product development. Integration involves expanding into new stages of the value chain. Backward integration occurs when a firm enters a supplier's business while forward vertical integration occurs when a firm enters a customer's business. Diversification involves entering entirely new industries; this can be an industry that is related or unrelated to a firm's existing activities. Sometimes being smart about corporate-level strategy requires shrinking the firm through retrenchment or restructuring. Finally, portfolio planning can be useful for analyzing firms that participate in a wide variety of industries.

Exercises

1. Divide your class into four or eight groups, depending on the size of the class. Each group should create a new portfolio planning technique by selecting two dimensions along which companies can be analyzed. Allow each group three to five minutes to present its approach to the class. Discuss which portfolio planning technique seems to offer the best insights.
2. This chapter discussed Disney. Imagine that you were hired as a consultant by General Electric (GE), a firm that competes with Disney in the movie, television, and theme park industries. What actions would you recommend that GE take in these three industries to gain advantages over Disney?

Chapter 9: Executing Strategy through Organizational Design

Chapter 9: Executing Strategy through Organizational Design

9.1 Executing Strategy through Organizational Design

9.2 The Basic Building Blocks of Organizational Structure

9.3 Creating an Organizational Structure

9.4 Creating Organizational Control Systems

9.5 Legal Forms of Business

9.6 Conclusion

9.1 Executing Strategy through Organizational Design

Learning Objectives

After reading this chapter, you should be able to understand and articulate answers to the following questions:

1. What are the basic building blocks of organizational structure?
2. What types of structures exist, and what are advantages and disadvantages of each?
3. What is control and why is it important?
4. What are the different forms of control and when should they be used?
5. What are the key legal forms of business, and what implications does the choice of a business form have for organizational structure?

Can Oil Well Services Fuel Success for GE?



General Electric's logo has changed little since its creation in the 1890s, but the company has grown to become the sixth largest in the United States.

[Wikimedia Commons](#) – public domain.

In February 2011, General Electric (GE) reached an agreement to acquire the well-support division of John Wood Group PLC for \$2.8 billion. This was GE's third acquisition of a company that provides services to oil wells in only five months. In October 2010, GE added the deepwater exploration capabilities of Wellstream Holdings PLC for \$1.3 billion. In December 2010, part and equipment maker Dresser was acquired for \$3 billion. By spending more than \$7 billion on these acquisitions, GE executives made it clear that they had big plans within the oil well services business.

While many executives would struggle to integrate three new companies into their firms, experts expected GE's leaders to smoothly execute the transitions. In describing the acquisition of John Wood Group PLC, for example, one Wall Street analyst noted, "This is a nice bolt-on deal for GE (Layne, 2011)." In other words, this analyst believed that John Wood Group PLC could be seamlessly added to GE's corporate empire. The way that GE was organized fueled this belief.

GE's organizational structure includes six divisions, each devoted to specific product categories: (1) Energy (the most profitable division), (2) Capital (the largest division), (3) Home & Business Solutions, (4) Healthcare, (5) Aviation, and (6) Transportation. Within the Energy division, there are three subdivisions: (1) Oil & Gas, (2)

Power & Water, and (3) Energy Services. Rather than having the entire organization involved with integrating John Wood Group PLC, Wellstream Holdings PLC, and Dresser into GE, these three newly acquired companies would simply be added to the Oil & Gas subdivisions within the Energy division.

In addition to the six product divisions, GE also had a division devoted to Global Growth & Operations. This division was responsible for all sales of GE products and services outside the United States. The Global Growth & Operations division was very important to GE's future. Indeed, GE's CEO Jeffrey Immelt expected that countries other than the United States will account for 60 percent of GE's sales in the future, up from 53 percent in 2010. To maximize GE's ability to respond to local needs, the Global Growth & Operations was further divided into twelve geographic regions: China, India, Southeast Asia, Latin/South America, Russia, Canada, Australia, the Middle East, Africa, Germany, Europe, and Japan (GE News Center, 2010).

Finally, like many large companies, GE also provided some centralized services to support all its units. These support areas included public relations, business development, legal, global research, human resources, and finance. By having entire units of the organization devoted to these functional areas, GE hoped not only to minimize expenses but also to create consistency across divisions.

Growing concerns about the environmental effects of drilling, for example, made it likely that GE's oil well services operations would need the help of GE's public relations and legal departments in the future. Other important questions about GE's acquisitions remained open as well. In particular, would the organizational cultures of John Wood Group PLC, Wellstream Holdings PLC, and Dresser mesh with the culture of GE? Most acquisitions in the business world fail to deliver the results that executives expect, and the incompatibility of organizational cultures is one reason why.

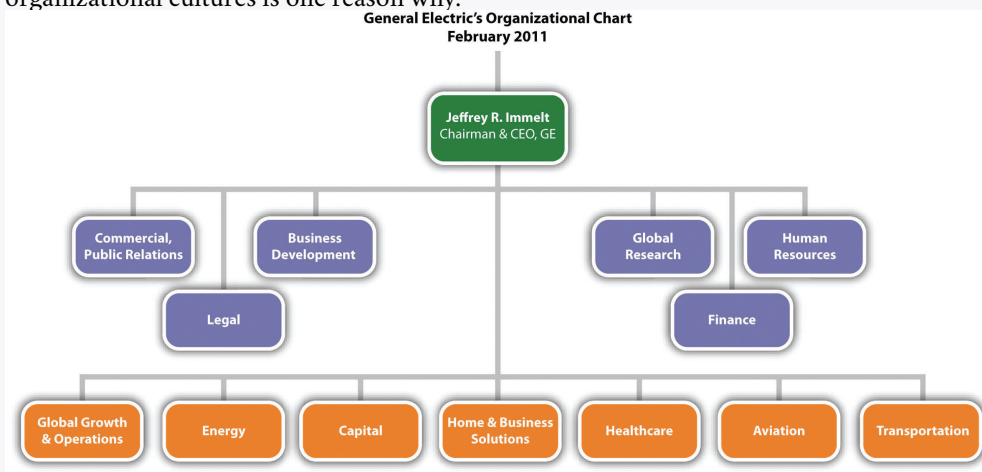

GE fits a dizzying array of businesses into a relatively simple organizational chart.

Adapted from company document posted at http://www.ge.com/pdf/company/ge_organization_chart.pdf

The word *executing* used in this chapter's title has two distinct meanings. These meanings were cleverly intertwined in a quip by John McKay. McKay had the misfortune to be the head coach of a hapless professional football team. In one game, McKay's offensive unit played particularly poorly. When McKay was asked after the game what he thought of his offensive unit's execution, he wryly responded, "I am in favor of it."

In the context of business, execution refers to how well a firm such as GE implements the strategies that executives create for it. This involves the creation and operation of both an appropriate organizational structure and an appropriate organizational control processes. Executives who skillfully orchestrate structure and control are likely to lead their firms to greater levels of success. In contrast, those executives who fail to do so are likely to be viewed by stakeholders such as employees and owners in much the same way Coach McKay viewed his offense: as worthy of execution.

References

GE News Center, GE names vice chairman John Rice to lead GE Global Growth & Operations [Press release]. 2010, November 8. GE website. Retrieved from <http://www.genewscenter.com/Press-Releases/GE-Names-Vice-Chairman-John-Rice-to-Lead-GE-Global-Growth-Operations-2c8a.aspx>.

Layne, R. 2011, February 14. GE agrees to buy \$2.8 billion oil-service unit; shares surge. *Bloomberg Businessweek*. Retrieved from <http://www.businessweek.com/news/2011-02-14/ge-agrees-to-buy-2-8-billion-oil-service-unit-shares-surge.html>.

9.2 The Basic Building Blocks of Organizational Structure

Table 9.1 The Building Blocks of Organizational Structure

Legendary football coach Vince Lombardi once noted, “The achievements of an organization are the results of the combined effort of each individual.” Understanding how people can be most efficiently organized is the basis for modern management thought, and we illustrate the building blocks of organizational structure below.

Division of labor is a process of splitting up a task into a series of smaller tasks, each of which is performed by a specialist. In ancient Greece, historian Xenophon wrote about the division of labor in shoe making: one person cut out the shoes, another sewed the uppers together, and a third person assembled the parts.

An **organizational chart** is a diagram that depicts a firm’s structure.

Do you know what happens each year on the Wednesday of the last full week of April? It’s Administrative Professionals’ Day. Savvy workers mark this day with generosity. The reason involves **informal linkages**, which are unofficial relationships such as friendships that do not appear in organizational charts. Administrative professionals such as secretaries tend to be well informed about both policies and office politics. So keep them on your side!

Vertical linkages tie supervisors and subordinates together. These linkages show the lines of responsibility through which a supervisor delegates authority to subordinates, oversees their activities, evaluates their performance, and guides them toward improvement.

Horizontal linkages are formal relationships between equals in an organization. They often take the form of committees and task forces.

Employees may receive conflicting guidance about how to do their jobs if they work in a situation where multiple bosses are present. This problem can be avoided by following the **unity of command** principle, which states that each person should only report directly to one supervisor.

Learning Objectives

1. Understand what division of labor is and why it is beneficial.
2. Distinguish between vertical and horizontal linkages and know what functions each fulfills in an organizational structure.

Division of Labor

General Electric (GE) offers a dizzying array of products and services, including lightbulbs, jet engines, and loans. One way that GE could produce its lightbulbs would be to have individual employees work on one lightbulb at a time from start to finish. This would be very inefficient, however, so GE and most other organizations avoid this approach. Instead, organizations rely on **division of labor** when creating their products (Table 9.1 “The Building Blocks of Organizational Structure”). Division of labor is a process of splitting up a task (such as the creation of lightbulbs) into a series of smaller tasks, each of which is performed by a specialist.

Table 9.2 Hierarchy of Authority

We illustrate one of the oldest recorded stories that is relevant to the design of modern organizations below.

<p>After fleeing Egypt, Moses found himself as the sole judge of the entire Hebrew population. This was a daunting task because estimates suggest the population may've exceeded one million people.</p>	<p>Moses's father-in-law Jethro warned Moses that he would wear himself out if he tried to handle such a heavy load alone.</p>
<p>Jethro offered Moses some practical advice. He told Moses that he should teach the people decrees and laws in an effort to minimize trouble and act as an example to demonstrate how the people live and the duties they were to perform.</p>	<p>Rather than handling all judging himself, Moses should appoint capable and trustworthy officials over groups of thousands, hundreds, fifties, and tens. These men would serve as judges for the people at all times, and only the most difficult cases would be brought to Moses.</p>

Key Takeaway

This is perhaps the first recorded example of a clear **hierarchy of authority**—an arrangement of individuals based on rank. A similar idea is used today in the U.S. justice system where there are lower courts for easy-to-resolve cases and the Supreme Court only handles the most difficult cases.

The leaders at the top of organizations have long known that division of labor can improve efficiency. Thousands of years ago, for example, Moses's creation of a hierarchy of authority by delegating responsibility to other judges offered perhaps the earliest known example (Table 9.2 “Hierarchy of Authority”). In the eighteenth century, Adam Smith's book *The Wealth of Nations* quantified the tremendous advantages that division of labor offered for a pin factory. If a worker performed all the various steps involved in making pins himself, he could make about twenty pins per day. By breaking the process into multiple steps, however, ten workers could make forty-eight thousand pins a day. In other words, the pin factory was a staggering 240 times more productive than it would have been without relying on division of labor. In the early twentieth century, Smith's ideas strongly influenced Henry Ford and other industrial pioneers who sought to create efficient organizations.

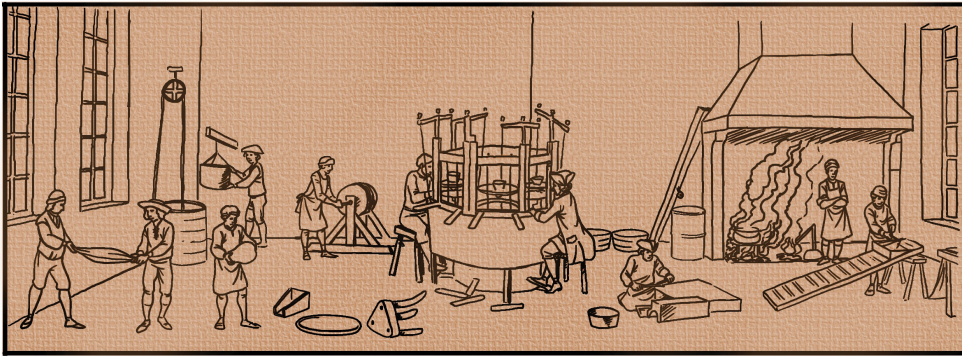

Division of labor allowed eighteenth-century pin factories to dramatically increase their efficiency.

While division of labor fuels efficiency, it also creates a challenge—figuring out how to coordinate different tasks and the people who perform them. The solution is **organizational structure**, which is defined as how tasks are assigned and grouped together with formal reporting relationships. Creating a structure that effectively coordinates a firm's activities increases the firm's likelihood of success. Meanwhile, a structure that does not match well with a firm's needs undermines the firm's chances of prosperity.

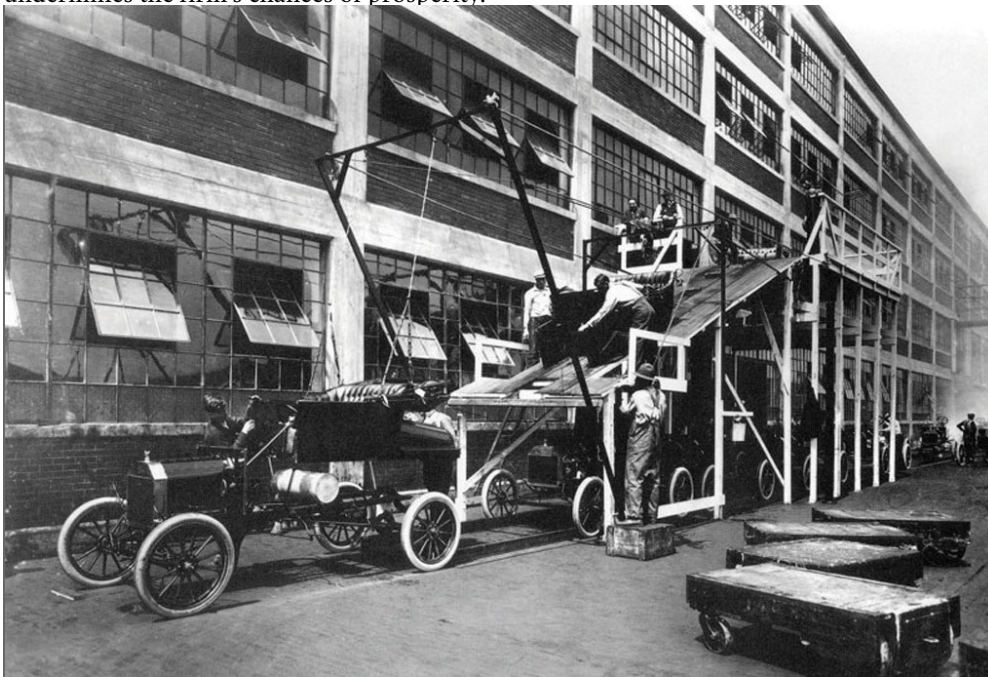

Division of labor was central to Henry Ford's development of assembly lines in his automobile factory. Ford noted, "Nothing is particularly hard if you divide it into small jobs."

[Wikimedia Commons](#) – public domain.

Vertical and Horizontal Linkages

Most organizations use a diagram called an **organizational chart** to depict their structure. These organizational charts show how firms' structures are built using two basic building blocks: vertical linkages and horizontal linkages. **Vertical linkages** tie supervisors and subordinates together. These linkages show the lines of responsibility through which a

supervisor delegates authority to subordinates, oversees their activities, evaluates their performance, and guides them toward improvement when necessary. Every supervisor except for the person at the very top of the organization chart also serves as a subordinate to someone else. In the typical business school, for example, a department chair supervises a set of professors. The department chair in turn is a subordinate of the dean.

Most executives rely on the **unity of command** principle when mapping out the vertical linkages in an organizational structure. This principle states that each person should only report directly to one supervisor. If employees have multiple bosses, they may receive conflicting guidance about how to do their jobs. The unity of command principle helps organizations to avoid such confusion. In the case of General Electric, for example, the head of the Energy division reports only to the chief executive officer. If problems were to arise with executing the strategic move discussed in this chapter's opening vignette—joining the John Wood Group PLC with GE's Energy division—the head of the Energy division reports would look to the chief executive officer for guidance.

Horizontal linkages are relationships between equals in an organization. Often these linkages are called committees, task forces, or teams. Horizontal linkages are important when close coordination is needed across different segments of an organization. For example, most business schools revise their undergraduate curriculum every five or so years to ensure that students are receiving an education that matches the needs of current business conditions. Typically, a committee consisting of at least one professor from every academic area (such as management, marketing, accounting, and finance) will be appointed to perform this task. This approach helps ensure that all aspects of business are represented appropriately in the new curriculum.



Committee meetings can be boring, but they are often vital for coordinating efforts across departments.

Yohann Legrand – [Meeting](#) – CC BY-SA 2.0.

Organic grocery store chain Whole Foods Market is a company that relies heavily on horizontal linkages. As noted on their website, “At Whole Foods Market we recognize the importance of smaller tribal groupings to maximize familiarity and trust. We organize our stores and company into a variety of interlocking teams. Most teams have between 6 and 100 Team Members and the larger teams are divided further into a variety of sub-teams. The leaders of each team are also members of the Store Leadership Team and the Store Team Leaders are members of the Regional Leadership Team. This interlocking team structure continues all the way upwards to the Executive Team at the highest level of the company (Mackey, 2010).” This emphasis on teams is intended to develop trust throughout the organization, as well as to make full use of the talents and creativity possessed by every employee.

Informal Linkages

Informal linkages refer to unofficial relationships such as personal friendships, rivalries, and politics. In the long-running comedy series *The Simpsons*, Homer Simpson is a low-level—and very low-performing—employee at a nuclear power plant. In one episode, Homer gains power and influence with the plant’s owner, Montgomery Burns, which far exceeds Homer’s meager position in the organization chart, because Mr. Burns desperately wants to be a member of the bowling team that Homer captains. Homer tries to use his newfound influence for his own personal gain and naturally the organization as a whole suffers. Informal linkages such as this one do not appear in organizational charts, but they nevertheless can have (and often do have) a significant influence on how firms operate.

Key Takeaway

- The concept of division of labor (dividing organizational activities into smaller tasks) lies at the heart of the study of organizational structure. Understanding vertical, horizontal, and informal linkages helps managers to organize better the different individuals and job functions within a firm.

Exercises

1. How is division of labor used when training college or university football teams? Do you think you could use a different division of labor and achieve more efficiency?
2. What are some formal and informal linkages that you have encountered at your college or university? What informal linkages have you observed in the workplace?

References

Mackey, John’s blog. 2010, March 9. Creating the high trust organization [Web blog post]. Retrieved from <http://www2.wholefoodsmarket.com/blogs/jmackey/2010/03/09/creating-the-high-trust-organization/>.

9.3 Creating an Organizational Structure

Learning Objectives

1. Know and be able to differentiate among the four types of organizational structure.
2. Understand why a change in structure may be needed.

Within most firms, executives rely on vertical and horizontal linkages to create a structure that they hope will match the needs of their firm's strategy. Four types of structures are available to executives: (1) simple, (2) functional, (3) multidivisional, and (4) matrix (Table 9.3 "Common Organizational Structures"). Like snowflakes, however, no two organizational structures are exactly alike. When creating a structure for their firm, executives will take one of these types and adapt it to fit the firm's unique circumstances. As they do this, executives must realize that the choice of structure will influence their firm's strategy in the future. Once a structure is created, it constrains future strategic moves. If a firm's structure is designed to maximize efficiency, for example, the firm may lack the flexibility needed to react quickly to exploit new opportunities.

Table 9.3 Common Organizational Structures

Executives rely on vertical and horizontal linkages to create a structure that they hope will match the firm's needs. While no two organizational structures are exactly alike, four general types of structures are available to executives: simple functional, multidivisional, and matrix.

Simple Structure	Simple structures do not rely on formal systems of division of labor, and organizational charts are not generally needed. If the firm is a sole proprietorship, one person performs all of the tasks that the organization needs to accomplish. Consequently, this structure is common for many small businesses.
Functional Structure	Within a functional structure, employees are divided into departments that each handles activities related to a functional area of the business, such as marketing, production, human resources, information technology, and customer service.
Multidivisional Structure	In this type of structure, employees are divided into departments based on product areas and/or geographic regions. General Electric, for example, has six product divisions: Energy, Capital, Home & Business Solutions, Healthcare, Aviation, and Transportation.
Matrix Structure	Firms that engage in projects of limited duration often use a matrix structure where employees can be put on different teams to maximize creativity and idea flow. As parodied in the movie <i>Office Space</i> , this structure is common in high tech and engineering firms.

Simple Structure

Many organizations start out with a **simple structure**. In this type of structure, an organizational chart is usually not needed. Simple structures do not rely on formal systems of division of labor (Table 9.4 “Simple Structure”). If the firm is a sole proprietorship, one person performs all the tasks the organization needs to accomplish. For example, on the TV series *The Simpsons*, both bar owner Moe Szyslak and the Comic Book Guy are shown handling all aspects of their respective businesses.

Table 9.4 Simple Structure

Most small businesses begin with a simple structure where one person or a small set of people share the tasks needed to accomplish the firm’s goals with relatively little formalized division of labor. We illustrate a number of businesses that commonly rely upon a simple structure below.

<p>Need a few dollars to tide you over? You may want to pawn your rare coin collection. The pawn shop’s simple structure will mean that the same person values your coins, decides how much money you can borrow, and writes up your paperwork.</p>	<p>The reality show <i>Miami Ink</i> illustrates how a tattoo parlor’s simple structure governs a colorful set of tattoo artists who create body art for their patrons.</p>
<p>Architects often also act as marketers and accountants when drafting their small business plans.</p>	<p>Bait shop owners generally do not dive deep into their pockets to pay for additional personnel as many are owner operated.</p>
<p>When a dry cleaner is family owned as many are, all members of the family pitch in as needed to clean clothing and wait on customers.</p>	<p>There is flexibility in the management of many yoga studios given the laid back management style often embraced.</p>
<p>Instrument dealers may create beautiful music, but they rarely create complex organizational structures.</p>	<p>“Bridezillas” are an occupational hazard for bridal shops, but these shops are generally able to avoid the complexity associated with other organizational structures.</p>

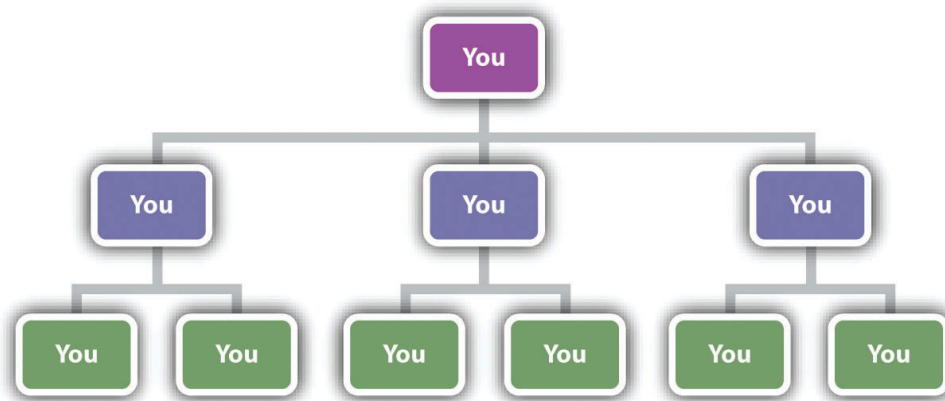

There is a good reason most sole proprietors do not bother creating formal organizational charts.

If the firm consists of more than one person, tasks tend to be distributed among them in an informal manner rather than each person developing a narrow area of specialization. In a family-run restaurant or bed and breakfast, for example, each person must contribute as needed to tasks, such as cleaning restrooms, food preparation, and serving guests (hopefully not in that order). Meanwhile, strategic decision making in a simple structure tends to be highly centralized. Indeed, often the owner of the firm makes all the important decisions. Because there is little emphasis on hierarchy within a simple structure, organizations that use this type of structure tend to have very few rules and regulations. The process of evaluating and rewarding employees' performance also tends to be informal.

The informality of simple structures creates both advantages and disadvantages. On the plus side, the flexibility offered by simple structures encourages employees' creativity and individualism. Informality has potential negative aspects, too. Important tasks may be ignored if no one person is specifically assigned accountability for them. A lack of clear guidance from the top of the organization can create confusion for employees, undermine their motivation, and make them dissatisfied with their jobs. Thus when relying on a simple structure, the owner of a firm must be sure to communicate often and openly with employees.

Functional Structure

As a small organization grows, the person in charge of it often finds that a simple structure is no longer adequate to meet the organization's needs. Organizations become more complex as they grow, and this can require more formal division of labor and a strong emphasis on hierarchy and vertical links. In many cases, these firms evolve from using a simple structure to relying on a [functional structure](#).

Table 9.5 Functional Structure

Functional structures rely on a division of labor whereby groups of people handle activities related to a specific function of the overall business. We illustrate functional structures in action within two types of organizations that commonly use them.

Grocery Store Functions	Spa Functions
Grocery stockers often work at night to make sure shelves stay full during the day.	Some spa employees manicure fingernails, a practice that is over four thousand years old. Many also provide pedicures, a service whose popularity has nearly doubled in the past decade.
Pharmacists' specialized training allows them to command pay that can exceed \$50 an hour.	Compared to other spa functions, little training is required of a tanning bed operator—although the ability to tell time may help.
Bakers wake up early to give shoppers their daily bread.	Almost anyone can buy a shotgun or parent a child without any training, but every state requires a license in order to cut hair.
Bagging groceries requires a friendly personality as well as knowing that eggs should not go on the bottom.	Cucumber masks are usually applied by a skin care specialist who has taken a professional training program.
Folks that work checkout aisles should be trusted to handle cash.	The license required of massage therapists in many states ensures that spa visits end happily.
The creation of produce, deli, and butcher departments provides an efficient way to divide a grocery store physically as well as functionally.	

Within a functional structure, employees are divided into departments that each handle activities related to a functional area of the business, such as marketing, production, human resources, information technology, and customer service (Table 9.5 “Functional Structure”). Each of these five areas would be headed up by a manager who coordinates all activities related to her functional area. Everyone in a company that works on marketing the company’s products, for example, would report to the manager of the marketing department. The marketing managers and the managers in charge of the other four areas in turn would report to the chief executive officer.

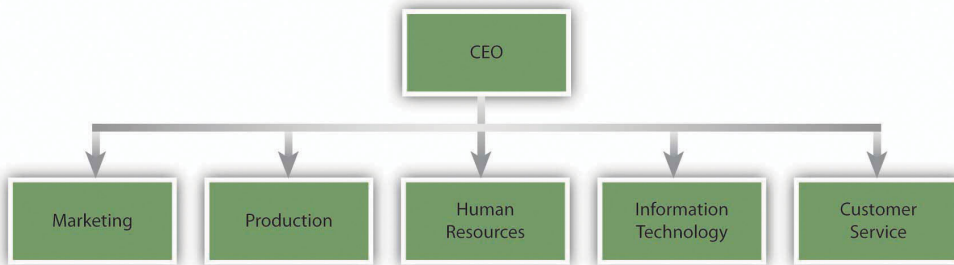

An example of a functional structure

Using a functional structure creates advantages and disadvantages. An important benefit of adopting a functional structure is that each person tends to learn a great deal about his or her particular function. By being placed in a department that consists entirely of marketing professionals, an individual has a great opportunity to become an expert in marketing. Thus a functional structure tends to create highly skilled specialists. Second, grouping everyone that

serves a particular function into one department tends to keep costs low and to create efficiency. Also, because all the people in a particular department share the same background training, they tend to get along with one another. In other words, conflicts within departments are relatively rare.

Using a functional structure also has a significant downside: executing strategic changes can be very slow when compared with other structures. Suppose, for example, that a textbook publisher decides to introduce a new form of textbook that includes “scratch and sniff” photos that let students smell various products in addition to reading about them. If the publisher relies on a simple structure, the leader of the firm can simply assign someone to shepherd this unique new product through all aspects of the publication process.

If the publisher is organized using a functional structure, however, every department in the organization will have to be intimately involved in the creation of the new textbooks. Because the new product lies outside each department’s routines, it may become lost in the proverbial shuffle. And unfortunately for the books’ authors, the publication process will be halted whenever a functional area does not live up to its responsibilities in a timely manner. More generally, because functional structures are slow to execute change, they tend to work best for organizations that offer narrow and stable product lines.

The specific functional departments that appear in an organizational chart vary across organizations that use functional structures. In the example offered earlier in this section, a firm was divided into five functional areas: (1) marketing, (2) production, (3) human resources, (4) information technology, and (5) customer service. In the TV show *The Office*, a different approach to a functional structure is used at the Scranton, Pennsylvania, branch of Dunder Mifflin. As of 2009, the branch was divided into six functional areas: (1) sales, (2) warehouse, (3) quality control, (4) customer service, (5) human resources, and (6) accounting. A functional structure was a good fit for the branch at the time because its product line was limited to just selling office paper.

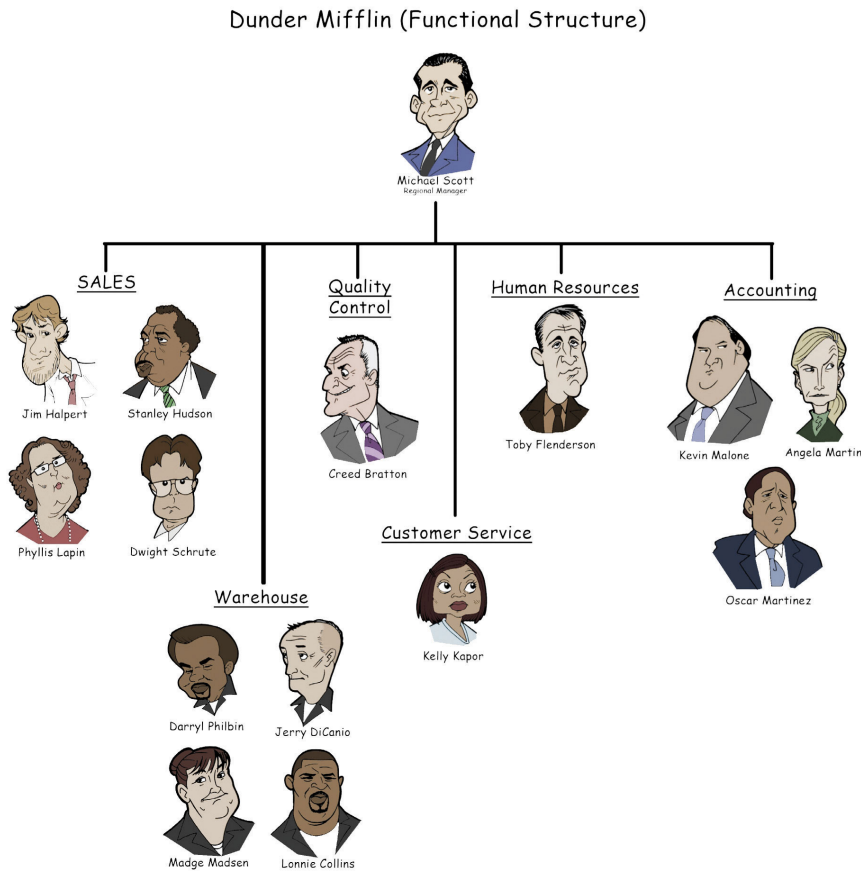

The Scranton branch of Dunder Mifflin may be a dysfunctional organization, but it relies on a functional structure.

Multidivisional Structure

Many organizations offer a wide variety of products and services. Some of these organizations sell their offerings across an array of geographic regions. These approaches require firms to be very responsive to customers' needs. Yet, as noted, functional structures tend to be fairly slow to change. As a result, many firms abandon the use of a functional structure as their offerings expand. Often the new choice is a **multidivisional structure**. In this type of structure, employees are divided into departments based on product areas and/or geographic regions.

General Electric (GE) is an example of a company organized this way. As shown in the organization chart that accompanies this chapter's opening vignette, most of the company's employees belong to one of six product divisions (Energy, Capital, Home & Business Solutions, Health Care, Aviation, and Transportation) or to a division that is devoted to all GE's operations outside the United States (Global Growth & Operations).

A big advantage of a multidivisional structure is that it allows a firm to act quickly. When GE makes a strategic

move such as acquiring the well-supported division of John Wood Group PLC, only the relevant division (in this case, Energy) needs to be involved in integrating the new unit into GE's hierarchy. In contrast, if GE was organized using a functional structure, the transition would be much slower because all the divisions in the company would need to be involved. A multidivisional structure also helps an organization to better serve customers' needs. In the summer of 2011, for example, GE's Capital division started to make real-estate loans after exiting that market during the financial crisis of the late 2000s (Jacobius, 2011). Because one division of GE handles all the firm's loans, the wisdom and skill needed to decide when to reenter real-estate lending was easily accessible.

Of course, empowering divisions to act quickly can backfire if people in those divisions take actions that do not fit with the company's overall strategy. McDonald's experienced this kind of situation in 2002. In particular, the French division of McDonald's ran a surprising advertisement in a magazine called *Femme Actuelle*. The ad included a quote from a nutritionist that asserted children should *not* eat at a McDonald's more than once per week. Executives at McDonald's headquarters in suburban Chicago were concerned about the message sent to their customers, of course, and they made it clear that they strongly disagreed with the nutritionist.



Problems can be created when delegating lots of authority to local divisions. McDonald's top executives were angered when an ad by their French division suggested that children should only eat at their restaurants once a week.

Alfonsina Blyde – [Everything to see you smile](#) – CC BY-NC-ND 2.0.

Another downside of multidivisional structures is that they tend to be more costly to operate than functional structures. While a functional structure offers the opportunity to gain efficiency by having just one department handle all activities in an area, such as marketing, a firm using a multidivisional structure needs to have marketing units within each of its divisions. In GE's case, for example, each of its seven divisions must develop marketing skills. Absorbing the extra expenses that are created reduces a firm's profit margin.

GE's organizational chart highlights a way that firms can reduce some of these expenses: the centralization of some

functional services. As shown in the organizational chart, departments devoted to important aspects of public relations, business development, legal, global research, human resources, and finance are maintained centrally to provide services to the six product divisions and the geographic division. By consolidating some human resource activities in one location, for example, GE creates efficiency and saves money.

An additional benefit of such moves is that consistency is created across divisions. In 2011, for example, the Coca-Cola Company created an Office of Sustainability to coordinate sustainability initiatives across the entire company. Bea Perez was named Coca-Cola's chief sustainability officer and was put in charge of the Office of Sustainability. At the time, Coca-Cola's chief executive officer Muhtar Kent noted that Coca-Cola had "made significant progress with our sustainability initiatives, but our current approach needs focus and better integration (McWilliams, 2011)." In other words, a department devoted to creating consistency across Coca-Cola's sustainability efforts was needed for Coca-Cola to meet its sustainability goals.

Matrix Structure

Within functional and multidivisional structures, vertical linkages between bosses and subordinates are the most elements. **Matrix structures**, in contrast, rely heavily on horizontal relationships (Ketchen & Short, 2011). In particular, these structures create cross-functional teams that each work on a different project. This offers several benefits: maximizing the organization's flexibility, enhancing communication across functional lines, and creating a spirit of teamwork and collaboration. A matrix structure can also help develop new managers. In particular, a person without managerial experience can be put in charge of a relatively small project as a test to see whether the person has a talent for leading others.

Using a matrix structure can create difficulties too. One concern is that using a matrix structure violates the unity of command principle because each employee is assigned multiple bosses. Specifically, any given individual reports to a functional area supervisor as well as one or more project supervisors. This creates confusion for employees because they are left unsure about who should be giving them direction. Violating the unity of command principle also creates opportunities for unsavory employees to avoid responsibility by claiming to each supervisor that a different supervisor is currently depending on their efforts.

The potential for conflicts arising between project managers within a matrix structure is another concern. Chances are that you have had some classes with professors who are excellent speakers while you have been forced to suffer through a semester of incomprehensible lectures in other classes. This mix of experiences reflects a fundamental reality of management: in any organization, some workers are more talented and motivated than others. Within a matrix structure, each project manager naturally will want the best people in the company assigned to her project because their boss evaluates these managers based on how well their projects perform. Because the best people are a scarce resource, infighting and politics can easily flare up around which people are assigned to each project.

Given these problems, not every organization is a good candidate to use a matrix structure. Organizations such as engineering and consulting firms that need to maximize their flexibility to service projects of limited duration can benefit from the use of a matrix. Matrix structures are also used to organize research and development departments within many large corporations. In each of these settings, the benefits of organizing around teams are so great that they often outweigh the risks of doing so.

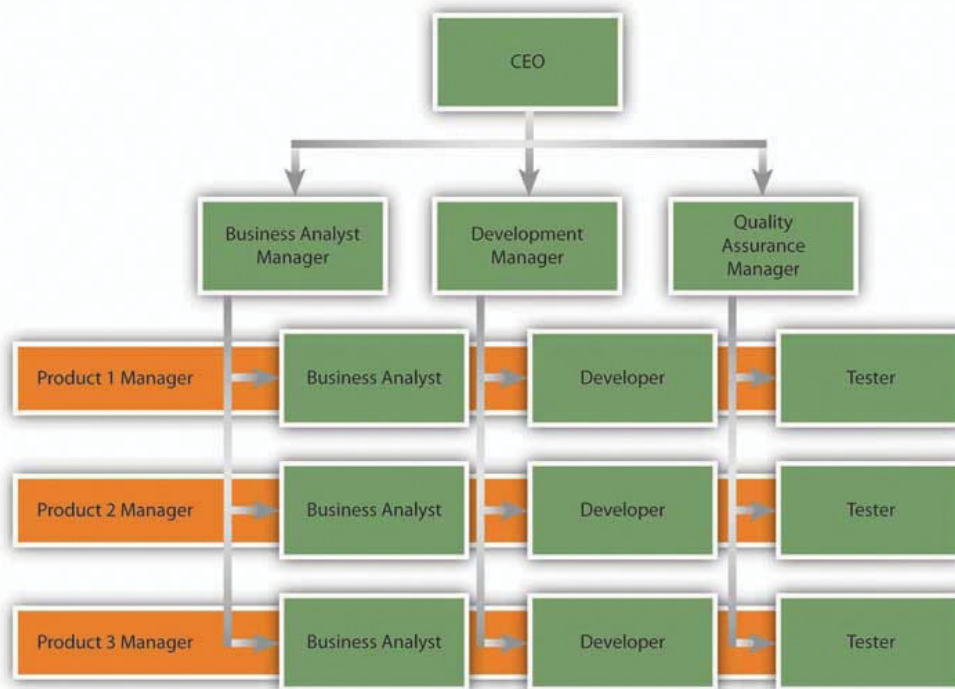

You won't need to choose between a red pill and a blue pill within a matrix structure, but you will have multiple bosses.

Strategy at the Movies

Office Space

How much work can a man accomplish with eight bosses breathing down his neck? For Peter Gibbons, an employee at information technology firm Initech in the 1999 movie *Office Space*, the answer was zero. Initech's use of a matrix structure meant that each employee had multiple bosses, each representing a different aspect of Initech's business. High-tech firms often use matrix to gain the flexibility needed to manage multiple projects simultaneously. Successfully using a matrix structure requires excellent communication among various managers—however, excellence that Initech could not reach. When Gibbons forgot to put the appropriate cover sheet on his TPS report, each of his eight bosses—and a parade of his coworkers—admonished him. This fiasco and others led to Gibbons to become cynical about his job.

Simpler organizational structures can be equally frustrating. Joanna, a waitress at nearby restaurant Chotchkie's, had only one manager—a stark contrast to Gibbons's eight bosses. Unfortunately, Joanna's manager had an unhealthy obsession with the “flair” (colorful buttons and pins) used by employees to enliven their uniforms. A series of mixed messages about the restaurant's policy on flair led Joanna to emphatically proclaim—both verbally and nonverbally—her disdain for the manager. She then quit her job and stormed out of the restaurant.

Office Space illustrates the importance of organizational design decisions to an organization's culture and to employees' motivation levels. A matrix structure can facilitate resource sharing and collaboration but may also create complicated working relationships and impose excessive stress on employees. Chotchkie's organizational structure involved simpler working relationships, but these relationships were strained beyond the breaking

point by a manager's eccentricities. In a more general sense, *Office Space* shows that all organizational structures involve a series of trade-offs that must be carefully managed.



Within a poorly organized firm like Initech, simply keeping possession of a treasured stapler is a challenge.

[Wikimedia Commons](#) – public domain.

Boundaryless Organizations

Most organizational charts show clear divisions and boundaries between different units. The value of a much different approach was highlighted by former GE CEO Jack Welch when he created the term **boundaryless organization**. A boundaryless organization is one that removes the usual barriers between parts of the organization as well as barriers between the organization and others (Askenas, et. al., 1995). Eliminating all internal and external barriers is not possible, of course, but making progress toward being boundaryless can help an organization become more flexible and responsive. One example is W.L. Gore, a maker of fabrics, medical implants, industrial sealants, filtration systems, and consumer products. This firm avoids organizational charts, management layers, and supervisors despite having approximately nine thousand employees across thirty countries. Rather than granting formal titles to certain people, leaders with W.L. Gore emerge based on performance and they attract followers to their ideas over time. As one employee noted, “We vote with our feet. If you call a meeting, and people show up, you’re a leader (Hamel, 2007).”



The boundaryless approach to structure embraced by W.L. Gore drives the kind of creative thinking that led to their most famous product, GORE-TEX.

Adifansnet – [adidas_Men's_WINTER STORY](#) – CC BY-SA 2.0.

An illustration of how removing barriers can be valuable has its roots in a very unfortunate event. During 2005's Hurricane Katrina, rescue efforts were hampered by a lack of coordination between responders from the National Guard (who are controlled by state governments) and from active-duty military units (who are controlled by federal authorities). According to one National Guard officer, "It was just like a solid wall was between the two entities (Elliott, 2011)." Efforts were needlessly duplicated in some geographic areas while attention to other areas was delayed or inadequate. For example, poor coordination caused the evacuation of thousands of people from the New Orleans Superdome to be delayed by a full day. The results were immense human suffering and numerous fatalities.



In 2005, boundaries between organizations hampered rescue efforts following Hurricane Katrina.

[Wikimedia Commons](#) – public domain.

To avoid similar problems from arising in the future, barriers between the National Guard and active-duty military units are being bridged by special military officers called dual-status commanders. These individuals will be empowered to lead both types of units during a disaster recovery effort, helping to ensure that all areas receive the attention they need in a timely manner.

Reasons for Changing an Organization's Structure

Creating an organizational structure is not a onetime activity. Executives must revisit an organization's structure over time and make changes to it if certain danger signs arise. For example, a structure might need to be adjusted if decisions with the organization are being made too slowly or if the organization is performing poorly. Both these problems plagued Sears Holdings in 2008, leading executives to reorganize the company.



Although it was created to emphasize the need for unity among the American colonies, this famous 1754 graphic by Ben Franklin also illustrates a fundamental truth about structure: If the parts that make up a firm do not work together, the firm is likely to fail.

[Wikimedia Commons](#) – public domain.

Sears's new structure organized the firm around five types of divisions: (1) operating businesses (such as clothing, appliances, and electronics), (2) support units (certain functional areas such as marketing and finance), (3) brands (which focus on nurturing the firm's various brands such as Lands' End, Joe Boxer, Craftsman, and Kenmore), (4) online, and (5) real estate. At the time, Sears's chairman Edward S. Lampert noted that "by creating smaller focused teams that are clearly responsible for their units, we [will] increase autonomy and accountability, create greater ownership and enable faster, better decisions (Retail Net)." Unfortunately, structural changes cannot cure all a company's ills. As of July 2011, Sears's stock was worth just over half what it had been worth five years earlier.

Sometimes structures become too complex and need to be simplified. Many observers believe that this description fits Cisco. The company's CEO, John Chambers, has moved Cisco away from a hierarchical emphasis toward a focus on horizontal linkages. As of late 2009, Cisco had four types of such linkages. For any given project, a small team of people reported to one of forty-seven boards. The boards averaged fourteen members each. Forty-three of these boards each reported to one of twelve councils. Each council also averaged fourteen members. The councils reported to an operating committee consisting of Chambers and fifteen other top executives. Four of the forty-seven boards bypassed the councils and reported directly to the operating committee. These arrangements are so complex and time consuming that some top executives spend 30 percent of their work hours serving on more than ten of the boards, councils, and the operating committee.

Because it competes in fast-changing high-tech markets, Cisco needs to be able to make competitive moves quickly. The firm's complex structural arrangements are preventing this. In late 2007, Hewlett-Packard (HP) started promoting a warranty service that provides free support and upgrades within the computer network switches market. Because Cisco's response to this initiative had to work its way through multiple committees, the firm did not take action until April 2009. During the delay, Cisco's share of the market dropped as customers embraced HP's warranty. This problem and others created by Cisco's overly complex structure were so severe that one columnist wondered aloud "has Cisco's John Chambers lost his mind (Blodget, 2009)?" In the summer of 2011, Chambers reversed course and decided to return Cisco to a more traditional structure while reducing the firm's workforce by 9 percent. Time will tell whether these structural changes will boost Cisco's stock price, which remained flat between 2006 and mid-2011.

Key Takeaway

- Executives must select among the four types of structure (simple, functional, multidivisional, and matrix) available to organize operations. Each structure has unique advantages, and the selection of structures involves a series of trade-offs.

Exercises

1. What type of structure best describes the organization of your college or university? What led you to reach your conclusion?
2. The movie *Office Space* illustrates two types of structures. What are some other scenes or themes from movies that provide examples or insights relevant to understanding organizational structure?

References

- Askenas, R., Ulrich, D., Jick, T., & Kerr, S. 1995. *The boundaryless organization: Breaking down the chains of organizational structure*. San Francisco, CA: Jossey-Bass.
- Blodget, H. 2009, August 6. Has Cisco's John Chambers lost his mind? *Business Insider*. Retrieved from <http://www.businessinsider.com/henry-blodget-has-ciscos-john-chambers-lost-his-mind-2009-8>.
- Elliott, D. 2011, July 3. New type of commander may avoid Katrina-like chaos. *Yahoo! News*. Retrieved from <http://news.yahoo.com/type-commander-may-avoid-katrina-chaos-153143508.html>.
- Hamel, G. 2007, September 27. What Google, Whole Foods do best. *CNNMoney*. Retrieved from http://money.cnn.com/2007/09/26/news/companies/management_hamel.fortune/index.htm.
- Jacobius, A. 2011, July 25. GE Capital slowly moving back into lending waters. *Pensions & Investments*. Retrieved from <http://www.pionline.com/article/20110725/PRINTSUB/110729949>.
- Ketchen, D. J., & Short, J. C. 2011. Separating fads from facts: Lessons from "the good, the fad, and the ugly." *Business Horizons*, 54, 17–22.
- McWilliams, J. 2011, May 19. Coca-Cola names Bea Perez chief sustainability officer. *Atlantic-Journal Constitution*. Retrieved from <http://www.ajc.com/business/coca-cola-names-bea-951741.html>.

Retail Net, Sears restructures business units. *Retail Net*. Retrieved from <http://www.retailnet.com/story.cfm?ID=41613>.

9.4 Creating Organizational Control Systems

Learning Objectives

1. Understand the three types of control systems.
2. Know the strengths and weaknesses of common management fads.

In addition to creating an appropriate organizational structure, effectively executing strategy depends on the skillful use of organizational control systems. Executives create strategies to try to achieve their organization's vision, mission, and goals. **Organizational control systems** allow executives to track how well the organization is performing, identify areas of concern, and then take action to address the concerns. Three basic types of control systems are available to executives: (1) output control, (2) behavioral control, and (3) clan control. Different organizations emphasize different types of control, but most organizations use a mix of all three types.

Output Control

Output control focuses on measurable results within an organization. Examples from the business world include the number of hits a website receives per day, the number of microwave ovens an assembly line produces per week, and the number of vehicles a car salesman sells per month (Table 9.6 "Output Controls"). In each of these cases, executives must decide what level of performance is acceptable, communicate expectations to the relevant employees, track whether performance meets expectations, and then make any needed changes. In an ironic example, a group of post office workers in Pensacola, Florida, were once disappointed to learn that their paychecks had been lost—by the US Postal Service! The corrective action was simple: they started receiving their pay via direct deposit rather than through the mail.

Many times the stakes are much higher. In early 2011, Delta Air Lines was forced to face some facts as part of its use of output control. Data gathered by the federal government revealed that only 77.4 percent of Delta's flights had arrived on time during 2010. This performance led Delta to rank dead last among the major US airlines and fifteenth out of eighteen total carriers (Yamanouchi, 2011). In response, Delta took important corrective steps. In particular, the airline added to its ability to service airplanes and provided more customer service training for its employees. Because some delays are inevitable, Delta also announced plans to staff a Twitter account called Delta Assist around the clock to help passengers whose flights are delayed. These changes and others paid off. For the second quarter of 2011, Delta enjoyed a \$198 million profit, despite having to absorb a \$1 billion increase in its fuel costs due to rising prices (Yamanouchi, 2011).

Table 9.6 Output Controls

Outcome controls assess measurable production and other tangible results. Often output controls emphasize "bottom-line" performance. We illustrate some outcome controls found in organizations below.

Because real estate agents are paid a percentage of the selling price when a house sells, the number of dollars generated in houses sold is an important metric. Many realty offices have designations like “five million dollar club” to recognize very productive realtors.

Grade point averages provide a tangible means to compare students for employers and graduate schools.

In the movie *Elf*, the main character Buddy leaves Santa’s workshop when the number of Etch-A-Sketch toys he produces is nearly nine hundred units lower than the standard pace.

To earn tenure in a research-focused business schools, a professor’s output generally must include publishing numerous high-quality articles at reputable scholarly journals.

Within restaurants, servers can increase a key output—amount of tips received—by providing customers with fast, friendly, and high-quality service.

Output control also plays a big part in the college experience. For example, test scores and grade point averages are good examples of output measures. If you perform badly on a test, you might take corrective action by studying harder or by studying in a group for the next test. At most colleges and universities, a student is put on academic probation when his grade point average drops below a certain level. If the student’s performance does not improve, he may be removed from his major and even dismissed. On the positive side, output measures can trigger rewards too. A very high grade point average can lead to placement on the dean’s list and graduating with honors.



While most scholarships require a high GPA, comedian David Letterman created a scholarship for a “C” student at Ball State University. Ball State later named a new communications and media building after its very famous alumnus.

[Wikimedia Commons](#) – public domain.

Behavioral Control

Table 9.7 Behavioral Controls

Behavioral controls dictate the actions of individuals. Such controls often emphasize rules and procedures. We illustrate some behavioral controls found in organizations below.

No shoes, no shirt, no paycheck. Many food service companies have strict attire requirements to make sure employees are in compliance with the rules of the Food and Drug Administration and those of local health departments. Casual Fridays provide a welcome break in offices that enforce strict dress codes. Many businesses require that checks are signed by two people. This prevents a dishonest employee from embezzling money. Grading attendance is a behavioral control designed to force students to show up for class. This can be very helpful because research shows that attendance is positively related to grades. Unfortunately, however, there are no behavioral controls that force professors' lectures to be interesting.

Gotta go? Be careful to not take too much time at certain auto factories, where bathroom breaks are monitored in an effort to cut costs. Some employees of U.S. firms are limited to forty six minutes of bathroom time per shift, while Japanese automakers allow their American employees only 30 minutes per shift.

While output control focuses on results, **behavioral control** focuses on controlling the actions that ultimately lead to results. In particular, various rules and procedures are used to standardize or to dictate behavior (Table 9.7 "Behavioral Controls"). In most states, for example, signs are posted in restaurant bathrooms reminding employees that they must wash their hands before returning to work. The dress codes that are enforced within many organizations are another example of behavioral control. To try to prevent employee theft, many firms have a rule that requires checks to be signed by two people. And in a somewhat bizarre example, some automobile factories dictate to workers how many minutes they can spend in restrooms during their work shift.

Behavioral control also plays a significant role in the college experience. An illustrative (although perhaps unpleasant) example is penalizing students for not attending class. Professors grade attendance to dictate students' behavior; specifically, to force students to attend class. Meanwhile, if you were to suggest that a rule should be created to force professors to update their lectures at least once every five years, we would not disagree with you.

Outside the classroom, behavioral control is a major factor within college athletic programs. The National Collegiate Athletic Association (NCAA) governs college athletics using a huge set of rules, policies, and procedures. The NCAA's rulebook on behavior is so complex that virtually all coaches violate its rules at one time or another. Critics suggest that the behavioral controls instituted by the NCAA have reached an absurd level. Nevertheless, some degree of behavioral control is needed within virtually all organizations.

Creating an effective reward structure is key to effectively managing behavior because people tend to focus their efforts on the rewarded behaviors. Problems can arise when people are rewarded for behaviors that seem positive on the surface but that can actually undermine organizational goals under some circumstances. For example, restaurant servers are highly motivated to serve their tables quickly because doing so can increase their tips. But if a server devotes all his or her attention to providing fast service, other tasks that are vital to running a restaurant, such as communicating effectively with managers, host staff, chefs, and other servers, may suffer. Managers need to be aware of such trade-offs and strive to align rewards with behaviors. For example, waitstaff who consistently behave as team players could be assigned to the most desirable and lucrative shifts, such as nights and weekends.



Although some behavioral controls are intended for employees and not customers, following them is beneficial to everyone.

[Wikimedia Commons](#) – CC BY-SA 3.0.

Clan Control

Table 9.8 Clan Controls

Rather than measuring result (as in outcome control) or dictating behavior (as in behavioral control), clan control relies on

shared traditions, expectations, values, and norms to lead people to work toward the good of their organization. Some of the most interesting and unusual examples of clan control are found on college campuses. Below we illustrate a few striking examples that help build school spirit and loyalty.

Roughly one-quarter of Brandeis University's student body gets adorned in pain—and nothing else—at the annual Liquid Latex event.

No matter how you slice it, the Toast Toss seems strange to outsiders. University of Pennsylvania students fling the breakfast staple into the air after the third quarter of home football games.

Students at Texas Tech University honor the school's southwest heritage by throwing torillas at sporting events.

Instead of measuring results (as in outcome control) or dictating behavior (as in behavioral control), **clan control** is an informal type of control. Specifically, clan control relies on shared traditions, expectations, values, and norms to lead people to work toward the good of their organization (Table 9.8 “Clan Controls”). Clan control is often used heavily in settings where creativity is vital, such as many high-tech businesses. In these companies, output is tough to dictate, and many rules are not appropriate. The creativity of a research scientist would be likely to be stifled, for example, if she were given a quota of patents that she must meet each year (output control) or if a strict dress code were enforced (behavioral control).

Google is a firm that relies on clan control to be successful. Employees are permitted to spend 20 percent of their workweek on their own innovative projects. The company offers an “ideas mailing list” for employees to submit new ideas and to comment on others' ideas. Google executives routinely make themselves available two to three times per week for employees to visit with them to present their ideas. These informal meetings have generated a number of innovations, including personalized home pages and Google News, which might otherwise have never been adopted.



As part of the team-building effort at Google, new employees are known as Noogles and are given a propeller hat to wear.

[Wikimedia Commons](#) – CC BY-SA 3.0.

Some executives look to clan control to improve the performance of struggling organizations. In 2005, Florida

officials became fed up with complaints about surly clerks within the state's driver's license offices. The solution was to look for help with training employees from two companies that are well-known for friendly, engaged employees and excellent customer service. The first was The Walt Disney Company, which offers world-famous hospitality at its Orlando theme parks. The second was regional supermarket chain Publix, a firm whose motto stressed that "shopping is a pleasure" in its stores. The goal of the training was to build the sort of positive team spirit Disney and Publix enjoy. The state's highway safety director summarized the need for clan control when noting that "we've just got to change a little culture out there (Bousquet, 2005)."

Clan control is also important on many college campuses. Philanthropic and social organizations such as clubs, fraternities, and sororities often revolve around shared values and team spirit. More broadly, many campuses have treasured traditions that bind alumni together across generations. Purdue University, for example, proudly owns the world's largest drum. The drum is beaten loudly before home football games to fire up the crowd. After athletic victories, Auburn University students throw rolls of toilet paper into campus oak trees. At Clark University, Rollins College, and Emory University, time-honored traditions that involve spontaneously canceling classes surprise and delight students. These examples and thousands of others spread across the country's colleges and universities help students feel like they belong to something special.

Management Fads: Out of Control?

Table 9.9 Managing Management Fads

The emergence and disappearance of fads appears to be a predictable aspect of modern society. A fad arises when some element of culture—such as fashion, a toy, or a hairstyle—becomes enthusiastically embraced by a group of people. Fads also seem to be a predictable aspect of the business world. Below we illustrate several fads that executives have latched onto in an effort to improve their organizations' control systems.

Management by objectives	A supervisor and an employee create a series of goals that provide structure and motivation for the employee. A huge set of studies shows that setting challenging but attainable goals leads to good performance, but not every aspect of work can be captured by a goal.
Sensitivity training	Free-flowing group discussions are used to lead individuals toward greater understanding of themselves and others. Because a "mob mentality" can take over a group, sensitivity training too often degenerates into hostility and humiliation.
Quality circles	Volunteer employee groups developed to brainstorm new methods or processes to improve quality. Quality is important, but managers face trade-offs among quality, cost, flexibility, and speed. A singular obsession with quality sacrifices too much along other dimensions.
Strong culture	Fueled by 1982's <i>In Search of Excellence</i> and fascination with Japanese management systems, having a strong culture became viewed as crucial to organizational success. Within a few years, many of the "excellent" companies highlighted in the book had fallen on hard times. However, firms such as Disney continue to gain competitive advantage through their strong cultures.

Don't chase the latest management fads. The situation dictates which approach best accomplishes the team's mission.
Colin Powell

The emergence and disappearance of fads appears to be a predictable aspect of modern society. A fad arises when some element of popular culture becomes enthusiastically embraced by a group of people. Over the past few decades, for

example, fashion fads have included leisure suits (1970s), “Members Only” jackets (1980s), Doc Martens shoes (1990s), and Crocs (2000s). Ironically, the reason a fad arises is also usually the cause of its demise. The uniqueness (or even outrageousness) of a fashion, toy, or hairstyle creates “buzz” and publicity but also ensures that its appeal is only temporary (Ketchen & Short, 2011).

Fads also seem to be a predictable aspect of the business world (Table 9.9 “Managing Management Fads”). As with cultural fads, many provocative business ideas go through a life cycle of creating buzz, captivating a group of enthusiastic adherents, and then giving way to the next fad. Bookstore shelves offer a seemingly endless supply of popular management books whose premises range from the intriguing to the absurd. Within the topic of leadership, for example, various books promise to reveal the “leadership secrets” of an eclectic array of famous individuals such as Jesus Christ, Hillary Clinton, Attila the Hun, and Santa Claus.

Beyond the striking similarities between cultural and business fads, there are also important differences. Most cultural fads are harmless, and they rarely create any long-term problems for those that embrace them. In contrast, embracing business fads could lead executives to make bad decisions. As our quote from Colin Powell suggests, relying on sound business practices is much more likely to help executives to execute their organization’s strategy than are generic words of wisdom from Old St. Nick.

Many management fads have been closely tied to organizational control systems. For example, one of the best-known fads was an attempt to use output control to improve performance. **Management by objectives (MBO)** is a process wherein managers and employees work together to create goals. These goals guide employees’ behaviors and serve as the benchmarks for assessing their performance. Following the presentation of MBO in Peter Drucker’s 1954 book *The Practice of Management*, many executives embraced the process as a cure-all for organizational problems and challenges.

Like many fads, however, MBO became a good idea run amok. Companies that attempted to create an objective for every aspect of employees’ activities eventually discovered that this was unrealistic. The creation of explicit goals can conflict with activities involving tacit knowledge about the organization. Intangible notions such as “providing excellent customer service,” “treating people right,” and “going the extra mile” are central to many organizations’ success, but these notions are difficult if not impossible to quantify. Thus, in some cases, getting employees to embrace certain values and other aspects of clan control is more effective than MBO.

Quality circles were a second fad that built on the notion of behavioral control. Quality circles began in Japan in the 1960s and were first introduced in the United States in 1972. A **quality circle** is a formal group of employees that meets regularly to brainstorm solutions to organizational problems. As the name “quality circle” suggests, identifying behaviors that would improve the quality of products and the operations management processes that create the products was the formal charge of many quality circles.

While the quality circle fad depicted quality as the key driver of productivity, it quickly became apparent that this perspective was too narrow. Instead, quality is just one of four critical dimensions of the production process; speed, cost, and flexibility are also vital. Maximizing any one of these four dimensions often results in a product that simply cannot satisfy customers’ needs. Many products with perfect quality, for example, would be created too slowly and at too great a cost to compete in the market effectively. Thus trade-offs among quality, speed, cost, and flexibility are inevitable.

Improving clan control was the aim of **sensitivity-training groups (or T-groups)** that were used in many organizations in the 1960s. This fad involved gatherings of approximately eight to fifteen people openly discussing their emotions, feelings, beliefs, and biases about workplace issues. In stark contrast to the rigid nature of MBO, the T-group involved free-flowing conversations led by a facilitator. These discussions were thought to lead individuals to greater understanding of themselves and others. The anticipated results were more enlightened workers and a greater spirit of teamwork.

Research on social psychology has found that groups are often far crueler than individuals. Unfortunately, this meant that the candid nature of T-group discussions could easily degenerate into accusations and humiliation. Eventually, the T-group fad gave way to recognition that creating potentially hurtful situations has no place within an organization. Hints of the softer side of T-groups can still be observed in modern team-building fads, however. Perhaps the best known is the “trust game,” which claims to build trust between employees by having individuals fall backward and depend on their coworkers to catch them.

Improving clan control was the basis for the fascination with [organizational culture](#) that was all the rage in the 1980s. This fad was fueled by a best-selling 1982 book titled *In Search of Excellence: Lessons from America's Best-Run Companies*. Authors Tom Peters and Robert Waterman studied companies that they viewed as stellar performers and distilled eight similarities that were shared across the companies. Most of the similarities, including staying “close to the customer” and “productivity through people,” arose from powerful corporate cultures. The book quickly became an international sensation; more than three million copies were sold in the first four years after its publication.

Soon it became clear that organizational culture’s importance was being exaggerated. Before long, both the popular press and academic research revealed that many of Peters and Waterman’s “excellent” companies quickly had fallen on hard times. Basic themes such as customer service and valuing one’s company are quite useful, but these clan control elements often cannot take the place of holding employees accountable for their performance.



Spirited games of kickball can help build an organization's culture, but such events should not substitute for holding employees accountable for delivering results.

Matthew Peoples – [Kickball](#) – CC BY-NC 2.0.

The history of fads allows us to make certain predictions about today's hot ideas, such as empowerment, "good to great," and viral marketing. Executives who distill and act on basic lessons from these fads are likely to enjoy performance improvements. Empowerment, for example, builds on important research findings regarding employees—many workers have important insights to offer to their firms, and these workers become more engaged in their jobs when executives take their insights seriously. Relying too heavily on a fad, however, seldom turns out well.

Just as executives in the 1980s could not treat *In Search of Excellence* as a recipe for success, today's executives should avoid treating James Collins's 2001 best-selling book *Good to Great: Why Some Companies Make the Leap...and Others Don't* as a detailed blueprint for running their companies. Overall, executives should understand that management fads usually contain a core truth that can help organizations improve but that a balance of output, behavioral, and clan control is needed within most organizations. As legendary author Jack Kerouac noted, "Great things are not accomplished by those who yield to trends and fads and popular opinion."

Key Takeaway

- Organizational control systems are a vital aspect of executing strategy because they track performance and identify adjustments that need to be made. Output controls involve measurable results. Behavioral controls involve regulating activities rather than outcomes. Clan control relies on a set of shared values, expectations, traditions, and norms. Over time, a series of fads intended to improve organizational control processes have emerged. Although these fads tend to be seen as cure-alls initially, executives eventually realize that an array of sound business practices is needed to create effective organizational controls.

Exercises

1. What type of control do you think works most effectively with you and why?
2. What are some common business practices that you predict will be considered fads in the future?
3. How could you integrate each type of control into a college classroom to maximize student learning?

References

Bousquet, S. 2005, September 23. For surly license clerks. a pound of charm. *St Petersburg Times*. Retrieved from http://www.sptimes.com/2005/09/23/State/For_surly_license_cle.shtml.

Ketchen, D. J., & Short, J. C. 2011. Separating fads from facts: Lessons from "the good, the fad, and the ugly." *Business Horizons*, 54, 17–22.

Yamanouchi, K. 2011, February 10. Delta ranks near bottom in on-time performance. *Atlanta-Journal Constitution*. Retrieved from <http://www.ajc.com/business/delta-ranks-near-bottom-834380.html>.

Yamanouchi, K. 2011, July 27. Delta has \$198 million profit, says 2,000 took buyouts. *Atlanta-Journal Constitution*. Retrieved from <http://www.ajc.com/business/delta-has-198-million-1050461.html>.

9.5 Legal Forms of Business

Learning Objectives

1. Know the three basic legal forms of business.
2. Know the two specialized types of corporations.

Table 9.10 Business Forms

Making a profit is a key goal for the overwhelming majority of firms. How a firm's owners benefit from profits and suffer from losses varies across different legal forms of business. Below we illustrate how profits and losses are treated within different business forms.

A *sole proprietorship* is owned by one person. The firm and its owner are treated interchangeably—the owner is the only beneficiary of any profits and its personally responsible for any losses and debts. Most sole proprietorships are small, but entrepreneur James Cash Penney operated JCPenney as one for many years after buying out his two partners.

In a *partnership*, two or more partners jointly own the firm. A successful partnership requires trust because profits and losses are shared and because each partner is accountable for the actions of others. Partnerships are a common business form for dental practices and law offices.

A *corporation* such as Southwest Airlines separates ownership and management by issuing ownership shares that are publicly traded in stock markets. Shareholders do not directly receive profits or absorb losses, but profits and losses tend to be reflected in whether the firm's stock price rises or falls. Shareholders can also benefit from profits in the form of dividends. A disadvantage of this business form is double taxation: taxes are paid on corporate profits and on any dividends that corporate income fuels.

A *limited liability company (LLC)* can be thought of as a hybrid of a corporation and partnership. Like in a corporation, owners are not accountable for the firm's debts. A winner of a legal judgement against an LLC, for example, cannot claim the personal assets of the LLC's owners. LLC's also enjoy the management flexibility of partnerships. For federal tax purposes, an LLC must choose to be treated as a corporation, a partnership, or a sole proprietorship. Many architectural and consulting firms are organized as LLCs.

Choosing a Form of Business

The legal form a firm chooses to operate under is an important decision with implications for how a firm structures its

resources and assets. Several legal forms of business are available to executives. Each involves a different approach to dealing with profits and losses (Table 9.10 “Business Forms”).

There are three basic forms of business. A **sole proprietorship** is a firm that is owned by one person. From a legal perspective, the firm and its owner are considered one and the same. On the plus side, this means that all profits are the property of the owner (after taxes are paid, of course). On the minus side, however, the owner is personally responsible for the firm’s losses and debts. This presents a tremendous risk. If a sole proprietor is on the losing end of a significant lawsuit, for example, the owner could find his personal assets forfeited. Most sole proprietorships are small and many have no employees. In most towns, for example, there are a number of self-employed repair people, plumbers, and electricians who work alone on home repair jobs. Also, many sole proprietors run their businesses from their homes to avoid expenses associated with operating an office.

In a **partnership**, two or more partners share ownership of a firm. A partnership is similar to a sole proprietorship in that the partners are the only beneficiaries of the firm’s profits, but they are also responsible for any losses and debts. Partnerships can be especially attractive if each person’s expertise complements the others. For example, an accountant who specializes in preparing individual tax returns and another who has mastered business taxes might choose to join forces to offer customers a more complete set of tax services than either could offer alone.

From a practical standpoint, a partnership allows a person to take time off without closing down the business temporarily. Sander & Lawrence is a partnership of two home builders in Tallahassee, Florida. When Lawrence suffered a serious injury a few years ago, Sander was able to take over supervising his projects and see them through to completion. Had Lawrence been a sole proprietor, his customers would have suffered greatly. However, a person who chooses to be part of a partnership rather than operating alone as a sole proprietor also takes on some risk; your partner could make bad decisions that end up costing you a lot of money. Thus developing trust and confidence in one’s partner is very important.

Most large firms, such as Southwest Airlines, are organized as corporations. A key difference between a **corporation** on the one hand and a sole proprietorship and a partnership on the other is that corporations involve the separation of ownership and management. Corporations sell shares of ownership that are publicly traded in stock markets, and they are managed by professional executives. These executives may own a significant portion of the corporation’s stock, but this is not a legal requirement.

Another unique feature of corporations is how they deal with profits and losses. Unlike in sole proprietorships and partnerships, a corporation’s owners (i.e., shareholders) do not directly receive profits or absorb losses. Instead, profits and losses indirectly affect shareholders in two ways. First, profits and losses tend to be reflected in whether the firm’s stock price rises or falls. When a shareholder sells her stock, the firm’s performance while she has owned the stock will influence whether she makes a profit relative to her stock purchase. Shareholders can also benefit from profits if a firm’s executives decide to pay cash dividends to shareholders. Unfortunately, for shareholders, corporate profits and any dividends that these profits support are both taxed. This double taxation is a big disadvantage of corporations.

A specialized type of corporation called an **S corporation** avoids double taxation. Much like in a partnership, the firm’s profits and losses are reported on owners’ personal tax returns in proportion with each owner’s share of the firm. Although this is an attractive feature, an S corporation would be impractical for most large firms because the number of shareholders in an S corporation is capped, usually at one hundred. In contrast, Southwest Airlines has more than ten thousand shareholders. For smaller firms, such as many real-estate agencies, the S corporation is an attractive form of business.

A final form of business is very popular, yet it is not actually recognized by the federal government as a form of business. Instead, the ability to create a **limited liability company (LLC)** is granted in state laws. LLCs mix attractive features of corporations and partnerships. The owners of an LLC are not personally responsible for debts that the LLC accumulates (like in a corporation) and the LLC can be run in a flexible manner (like in a partnership). When paying federal taxes, however, an LLC must choose to be treated as a corporation, a partnership, or a sole proprietorship. Many home builders (including Sander & Lawrence), architectural businesses, and consulting firms are LLCs.

Key Takeaway

- The three major forms of business in the United States are sole proprietorships, partnerships, and corporations. Each form has implications for how individuals are taxed and resources are managed and deployed.

Exercises

1. Why are so many small firms sole proprietorships?
2. Find an example of a firm that operates as an LLC. Why do you think the owners of this firm chose this form of business over others?
3. Why might different forms of business be more likely to rely on a different organizational structure?

9.6 Conclusion

This chapter explains elements of organizational design that are vital for executing strategy. Leaders of firms, ranging from the smallest sole proprietorship to the largest global corporation, must make decisions about the delegation of authority and responsibility when organizing activities within their firms. Deciding how to best divide labor to increase efficiency and effectiveness is often the starting point for more complex decisions that lead to the creation of formal organizational charts. While small businesses rarely create organization charts, firms that embrace functional, multidivisional, and matrix structures often have reporting relationships with considerable complexity. To execute strategy effectively, managers also depend on the skillful use of organizational control systems that involve output, behavioral, and clan controls. Although introducing more efficient business practices to improve organizational functioning is desirable, executives need to avoid letting their firms become “out of control” by being skeptical of management fads. Finally, the legal form a business takes is an important decision with implications for a firm’s organizational structure.

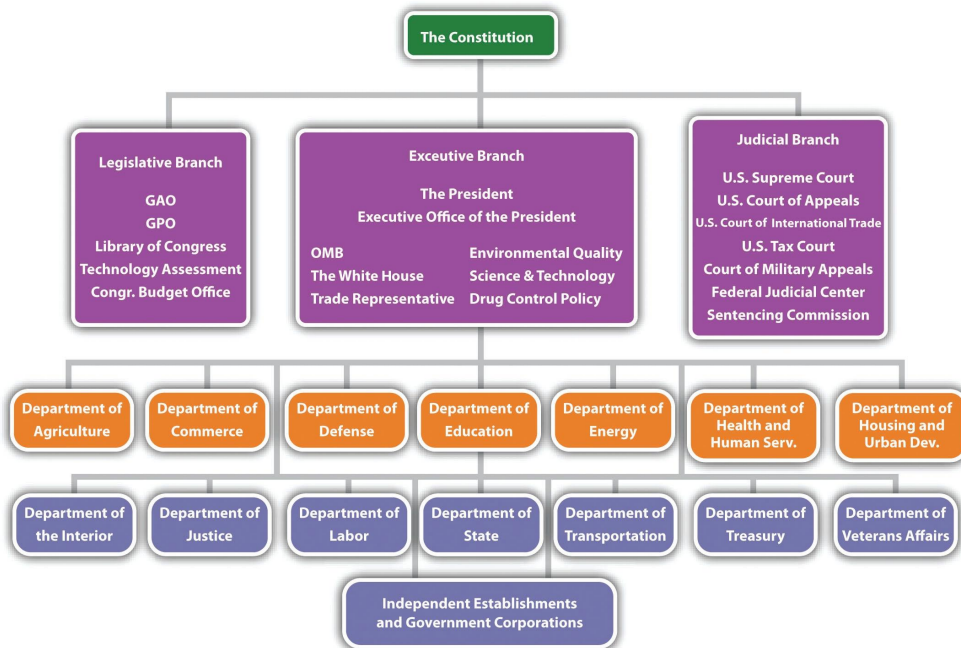

Exercises

1. The following chart is an organizational chart for the US federal government. What type of the four structures mentioned in this chapter best fits what you see in this chart?
2. How does this structure explain why the government seems to move at an incredibly slow pace?
3. What changes could be made to speed up the government? Would they be beneficial?

Chapter 10: Leading an Ethical Organization: Corporate Governance, Corporate Ethics, and Social Responsibility

Chapter 10: Leading an Ethical Organization: Corporate Governance, Corporate Ethics, and Social Responsibility

10.1 Leading an Ethical Organization: Corporate Governance, Corporate Ethics, and Social Responsibility

10.2 Boards of Directors

10.3 Corporate Ethics and Social Responsibility

10.4 Understanding Thought Patterns: A Key to Corporate Leadership?

10.5 Conclusion

10.1 Leading an Ethical Organization: Corporate Governance, Corporate Ethics, and Social Responsibility

Learning Objectives

After reading this chapter, you should be able to understand and articulate answers to the following questions:

1. What are the key elements of effective corporate governance?
2. How do individuals and firms gauge ethical behavior?
3. What influences and biases might impact and impede decision making?

TOMS Shoes: Doing Business with Soul



Under the business model used by TOMS Shoes, a pair of their signature alpargata footwear is donated for every pair sold.

Parke Ladd – [Quinn's new Tom's](#) – CC BY 2.0.

In 2002, Blake Mycoskie competed with his sister Paige on *The Amazing Race*—a reality show where groups of

two people with existing relationships engage in a global race to win valuable prizes, with the winner receiving a coveted grand prize. Although Blake's team finished third in the second season of the show, the experience afforded him the opportunity to visit Argentina, where he returned in 2006 and developed the idea to build a company around the alpargata—a popular style of shoe in that region.

The premise of the company Blake started was a unique one. For every shoe sold, a pair will be given to someone in need. This simple business model was the basis for TOMS Shoes, which has now given away more than one million pairs of shoes to those in need in more than twenty countries worldwide (Oloffson, 2010).

The rise of TOMS Shoes has inspired other companies that have adopted the “buy-one-give-one” philosophy. For example, the Good Little Company donates a meal for every package purchased (Nicolas, 2011). This business model has also been successfully applied to selling (and donating) other items such as glasses and books.

The social initiatives that drive TOMS Shoes stand in stark contrast to the criticisms that plagued Nike Corporation, where claims of human rights violations, ranging from the use of sweatshops and child labor to lack of compliance with minimum wage laws, were rampant in the 1990s (McCall, 1998). While Nike struggled to win back confidence in buyers that were concerned with their business practices, TOMS social initiatives are a source of excellent publicity in pride in those who purchase their products. As further testament to their popularity, TOMS has engaged in partnerships with Nordstrom, Disney, and Element Skateboards.

Although the idea of social entrepreneurship and the birth of firms such as TOMS Shoes are relatively new, a push toward social initiatives has been the source of debate for executives for decades. Issues that have sparked particularly fierce debate include CEO pay and the role of today's modern corporation. More than a quarter of a century ago, famed economist Milton Friedman argued, “The social responsibility of business is to increase its profits.” This notion is now being challenged by firms such as TOMS and their entrepreneurial CEO, who argue that serving other stakeholders beyond the owners and shareholders can be a powerful, inspiring, and successful motivation for growing business.

This chapter discusses some of the key issues and decisions relevant to understanding corporate and business ethics. Issues include how to govern large corporations in an effective and ethical manner, what behaviors are considered best practices in regard to corporate social performance, and how different generational perspectives and biases may hold a powerful influence on important decisions. Understanding these issues may provide knowledge that can encourage effective organizational leadership like that of TOMS Shoes and discourage the criticisms of many firms associated with the corporate scandals of the late 1990s and early 2000s.

References

- McCall, W. 1998. Nike battles backlash from overseas sweatshops. *Marketing News*, 9, 14.
- Nicolas, S. 2011, February. The great giveaway. *Director*, 64, 37–39.
- Oloffson, K. 2010, September 29. In Toms' Shoes: Start-up copy “one-for-one” model. *Wall Street Journal*. Retrieved from <http://online.wsj.com/article/SB10001424052748704116004575522251507063936.html>.

10.2 Boards of Directors

Learning Objectives

1. Understand the key roles played by boards of directors.
2. Know how CEO pay and perks impact the landscape of corporate governance.
3. Explain different terms associated with corporate takeovers.

The Many Roles of Boards of Directors

“You’re fired!” is a commonly used phrase most closely associated with Donald Trump as he dismisses candidates on his reality show, *The Apprentice*. But who would have the power to utter these words to today’s CEOs, whose paychecks are on par with many of the top celebrities and athletes in the world? This honor belongs to the **board of directors**—a group of individuals that oversees the activities of an organization or corporation.

Potentially firing or hiring a CEO is one of many roles played by the board of directors in their charge to provide effective **corporate governance** for the firm. An effective board plays many roles, ranging from the approval of financial objectives, advising on strategic issues, making the firm aware of relevant laws, and representing **stakeholders** who have an interest in the long-term performance of the firm (**Table 10.1 “Board Roles”**). Effective boards may help bring prestige and important resources to the organization. For example, General Electric’s board often has included the CEOs of other firms as well as former senators and prestigious academics. Blake Mycoskie of TOMS Shoes was touted as an ideal candidate for an “all-star” board of directors because of his ability to fulfill his company’s mission “to show how together we can create a better tomorrow by taking compassionate action today (Bunting, 2011).”

The key stakeholder of most corporations is generally agreed to be the shareholders of the company’s stock. Most large, publicly traded firms in the United States are made up of thousands of shareholders. While 5 percent ownership in many ventures may seem modest, this amount is considerable in publicly traded companies where such ownership is generally limited to other companies, and ownership in this amount could result in representation on the board of directors.

The possibility of conflicts of interest is considerable in public corporations. On the one hand, CEOs favor large salaries and job stability, and these desires are often accompanied by a tendency to make decisions that would benefit the firm (and their salaries) in the short term at the expense of decisions considered over a longer time horizon. In contrast, shareholders prefer decisions that will grow the value of their stock in the long term. This separation of interest creates an **agency problem** wherein the interests of the individuals that manage the company (agents such as the CEO) may not align with the interest of the owners (such as stockholders).

The composition of the board is critical because the dynamics of the board play an important part in resolving the agency problem. However, who exactly should be on the board is an issue that has been subject to fierce debate. CEOs often favor the use of **board insiders** who often have intimate knowledge of the firm’s business affairs. In contrast, many **institutional investors** such as mutual funds and pension funds that hold large blocks of stock in the firm often prefer significant representation by **board outsiders** that provide a fresh, nonbiased perspective concerning a firm’s actions.

One particularly controversial issue in regard to board composition is the potential for **CEO duality**, a situation in which the CEO is also the chairman of the board of directors. This has also been known to create a bitter divide within a corporation.

For example, during the 1990s, The Walt Disney Company was often listed in *BusinessWeek*'s rankings for having one of the worst boards of directors (Lavelle, 2002). In 2005, Disney's board forced the separation of then CEO (and chairman of the board) Michael Eisner's dual roles. Eisner retained the role of CEO but later stepped down from Disney entirely. Disney's story reflects a changing reality that boards are acting with considerably more influence than in previous decades when they were viewed largely as rubber stamps that generally folded to the whims of the CEO.

Table 10.1 Board Roles

William Shakespeare once wrote, "All the world's a stage, and the men and women merely players." This analogy applies well to boards of directors. When the performance of board members is impressive, the company is able to put on a dynamic show. But if a board member phones in their role, failure may soon follow. We discuss the different roles board members may play below.

Accountant	Board members may, at times, approve financial objectives.
Lawyer	Ensuring the firm complies with applicable laws is a key role.
Advisor	Providing advice on strategic issues is a critical role that is overlooked by less effective boards.
Activist	Boards must ensure the rights and interests of stakeholders (especially stockholders) are represented.
Human Resource Manager	Boards must monitor the CEO and engage in hiring, firing, and the administration of CEO compensation.
Agent	Because board members may serve in powerful positions at other companies, a well-networked board member may be able to bring new connections to the firm.

Managing CEO Compensation

One of the most visible roles of boards of directors is setting CEO pay. The valuation of the human capital associated with the rare talent possessed by some CEOs can be illustrated in a story of an encounter one tourist had with the legendary artist Pablo Picasso. As the story goes, Picasso was once spotted by a woman sketching. Overwhelmed with excitement at the serendipitous meeting, the tourist offered Picasso fair market value if he would render a quick sketch of her image. After completing his commission, she was shocked when he asked for five thousand francs, responding, "But it only took you a few minutes." Undeterred, Picasso retorted, "No, it took me all my life (Kay, 1999)."



Picasso's *Garçon à la pipe* was one of the most expensive works ever sold at more than \$100 million.

[Wikimedia Commons](#) – public domain.

This story illustrates the complexity associated with managing CEO compensation. On the one hand, large corporations must pay competitive wages for the scarce talent that is needed to manage billion-dollar corporations. In addition, like celebrities and sport stars, CEO pay is much more than a function of a day's work for a day's pay. CEO compensation is a function of the competitive wages that other corporations would offer for a potential CEO's services.

On the other hand, boards will face considerable scrutiny from investors if CEO pay is out of line with industry norms. From the year 1980 to 2000, the gap between CEO pay and worker pay grew from 42 to 1 to 475 to 1 (Blumenthal, 2000). Although efforts to close this gap have been made, as recently as 2008 reports indicate the ratio continues to be as high as 344 to 1, much higher than other countries, where an 80 to 1 ratio is common, or in Japan where the gap is just 16 to 1 (Feltman, 2009). Meanwhile, shareholders need to be aware that research studies have found that CEO pay is positively correlated with the size of firms—the bigger the firm, the higher the CEO's compensation (Tosi, et. al., 2000). Consequently, when a CEO tries to grow a company, such as by acquiring a rival firm, shareholders should question whether such growth is in the company's best interest or whether it is simply an effort by the CEO to get a pay raise.

Table 10.2 CEO Perks

Within American firms, the average CEO is paid over 200 times what the typical worker makes—one of the highest ratios in the world. Many CEOs also receive perks that the average employee could only dream possible. Such perks are trouble to the extent that they reflect the board’s lack of vigilance in monitoring CEO spending. We illustrate a few examples below.

Former Tyco CEO—now a convicted felon—Dennis Koslowski threw a week-long \$2 million birthday bash for his wife that included an ice-sculpture of Michelangelo’s David that dispensed vodka—top shelf, of course!

A pint-sized matter compared to the lavish perks of many executives, the sweet tooth should be satisfied for former Ben & Jerry’s CEO Robert Holland Jr., who will receive free ice cream for life.

Golden parachutes where CEOs receive large cash settlements if fired are common in publicly traded companies. Less common is the “golden coffin” that provides big settlements if an executive passes away in office. Abercrombie & Fitch CEO Michael Jefferies was offered \$6 million for his loyalty to the company...dead or alive.

Fore-closure! Countrywide Financial, now owned by Bank of America, paid nearly \$1 million dollars for executives’ country club memberships between 2003 through 2006.

Although Don Tyson of Tyson Foods retired in 2001, Tyson employees have been used to mow his yard and clean his house to keep things tidy postretirement.

In most publicly traded firms, CEO compensation generally includes guaranteed salary, cash bonus, and stock options. But perks provide another valuable source of CEO compensation (Table 10.2 “CEO Perks”). In addition to the controversy surrounding CEO pay, such perks associated with holding the position of CEO have also come under considerable scrutiny. The term *perks*, derived from *perquisite*, refers to special privileges, or rights, as a function of one’s position. CEO perks have ranged in magnitude from the sweet benefit of ice cream for life given to former Ben & Jerry’s CEO Robert Holland, to much more extreme benefits that raise the ears of investors while outraging employees. One such perk was provided to John Thain, who, as former head of NYSE Euronext, received more than \$1 million to renovate his office. While such perks may provide powerful incentives to stay with a company, they may result in considerable negative press and serve only to motivate vigilant investors wary of the value of such investments to shop elsewhere.

The Market for Corporate Governance

Table 10.3 Takeover Terms

The terms associated with mergers, acquisitions, and the actions used by executives to block these moves often sound like material from the latest war movie. We explain important terms below.

While a pirate raids a competitor’s vessel looking to loot valuable treasures, a **corporate raider** invades a firm by purchasing its stock.

Hostile takeover refers to an attempt to purchase a company that is strongly resisted by the target firm’s CEO and/or board.

Defenses against takeovers are often referred to as **shark repellent**. We illustrate a few below.

<p>A golden parachute is a financial package (often including stock options and bonuses worth millions of dollars) given to executives likely to lose their jobs after a takeover. These parachutes make taking over a firm more costly and thus less attractive.</p>	<p>When executives are desperate to avoid a takeover they may be forced to swallow a poison pill. This involves making the firm's stock unattractive to raiders by letting shareholders buy stock at a discount.</p>
<p>A firm that rescues a target firm by offering a friendly takeover as an alternative to a hostile one is known as a white knight.</p>	<p>In contrast to blackmail where information is withheld unless a demand is met, greenmail occurs when an unfriendly firm forces a target company to repurchase a large block of stock at a premium to thwart a takeover attempt.</p>

An old investment cliché encourages individuals to buy low and sell high. When a publicly traded firm loses value, often due to lack of vigilance on the part of the CEO and/or board, a company may become a target of a takeover wherein another firm or set of individuals purchases the company. Generally, the top management team is charged with revitalizing the firm and maximizing its assets.

In some cases, the takeover is in the form of a **leveraged buyout (LBO)** in which a publicly traded company is purchased and then taken off the stock market. One of the most famous LBOs was of RJR Nabisco, which inspired the book (and later film) *Barbarians at the Gate*. LBOs historically are associated with reduction in workforces to streamline processes and decrease costs. The managers who instigate buyouts generally bring a more entrepreneurial mind-set to the firm with the hopes of creating a turnaround from the same fate that made the company an attractive takeover target (recent poor performance) (Wright, et. al., 2001).

Many takeover attempts increase shareholder value. However, because most takeovers are associated with the dismissal of previous management, the terminology associated with change of ownership has a decidedly negative slant against the acquiring firm's management team. For example, individuals or firms that hope to conduct a takeover are often referred to as **corporate raiders**. An unsolicited takeover attempt is often dubbed a **hostile takeover**, with **shark repellent** as the potential defenses against such attempts. Although the poor management of a targeted firm is often the reason such businesses are potential takeover targets, when another firm that may be more favorable to existing management enters the picture as an alternative buyer, a **white knight** is said to have entered the picture (Table 10.3 "Takeover Terms").

The negative tone of takeover terminology also extends to the potential target firm. CEOs as well as board members are likely to lose their positions after a successful takeover occurs, and a number of antitakeover tactics have been used by boards to deter a corporate raid. For example, many firms are said to pay **greenmail** by repurchasing large blocks of stock at a premium to avoid a potential takeover. Firms may threaten to take a **poison pill** where additional stock is sold to existing shareholders, increasing the shares needed for a viable takeover. Even if the takeover is successful and the previous CEO is dismissed, a **golden parachute** that includes a lucrative financial settlement is likely to provide a soft landing for the ousted executive.

Key Takeaway

- Firms can benefit from superior corporate governance mechanisms such as an active board that monitors CEO actions, provides strategic advice, and helps to network to other useful resources.

When such mechanisms are not in place, CEO excess may go unchecked, resulting in negative publicity, poor firm performance, and potential takeover by other firms.

Exercises

1. Divide the class into teams and see who can find the most egregious CEO perk in the last year.
2. Find a listing of members of a board of directors for a *Fortune* 500 firm. Does the board seem to be composed of individuals who are likely to fulfill all the board roles effectively?
3. Research a hostile takeover in the past five years and examine the long-term impact on the firm's stock market performance. Was the takeover beneficial or harmful for shareholders?
4. Examine the AFL-CIO Executive Paywatch website (<http://www.aflcio.org/corporatewatch/paywatch>) and select a company of interest to see how many years you would need to work to earn a year's pay enjoyed by the firm's CEO.

References

- Blumenthal, R. G. 2000, September 4. The pay gap between workers and chiefs looks like a chasm. *Barron's*, 10.
- Bunting, C. 2011, February 23. Board of dreams: Fantasy board of directors. *Business News Daily*. Retrieved from <http://www.businessnewsdaily.com/681-board-of-directors-fantasy-picks-small-business.html>.
- Feltman, P. 2009. Experts examine pay disparity, other executive compensation issues. *SEC Filings Insight*, 15, 1–6.
- Kay, I. 1999. Don't devalue human capital. *Wall Street Journal—Eastern Edition*, 233, A18.
- Lavelle, L. 2002, October 7. The best and worst boards: How corporate scandals are sparking a revolution in governance. *BusinessWeek*, 104.
- Tosi, H. L., Werner, S., Katz, J. P., & Gomez-Mejia, L. R. 2000. How much does performance matter? A meta-analysis of CEO pay studies. *Journal of Management*, 26, 301–339.
- Wright, M., Hoskisson, R. E., & Busenitz, L. W. 2001. Firm rebirth: Buyouts as facilitators of strategic growth and entrepreneurship. *Academy of Management Executive*, 15, 111–125.

10.3 Corporate Ethics and Social Responsibility

Learning Objectives

1. Know the three levels and six stages of moral development suggested by Kohlberg.
2. Describe famous corporate scandals.
3. Understand how the Sarbanes-Oxley Act of 2002 provides a check on corporate ethical behavior in the United States.
4. Know the dimensions of corporate social performance tracked by KLD.

Stages of Moral Development

How do ethics evolve over time? Psychologist Lawrence Kohlberg suggests that there are six distinct stages of moral development and that some individuals move further along these stages than others (Kohlberg, 1981). Kohlberg's six stages were grouped into three levels: (1) preconventional, (2) conventional, and (3) postconventional (Table 10.4 "Stages of Moral Development").

The preconventional level of moral reasoning is very egocentric in nature, and moral reasoning is tied to personal concerns. In stage 1, individuals focus on the direct consequences that their actions will have—for example, worry about punishment or getting caught. In stage 2, right or wrong is defined by the reward stage, where a "what's in it for me" mentality is seen.

In the conventional level of moral reasoning, morality is judged by comparing individuals' actions with the expectations of society. In stage 3, individuals are conformity driven and act with the goal of fulfilling social roles. Parents that encourage their children to be good boys and girls use this form of moral guidance. In stage 4, the importance of obeying laws, social conventions, or other forms of authority to aid in maintaining a functional society is encouraged. You might witness encouragement under this stage when using a cell phone in a restaurant or when someone is chatting too loudly in a library.

The postconventional level, or principled level, occurs when morality is more than simply following social rules or norms. Stage 5 considers different values and opinions. Thus laws are viewed as social contracts that promote the greatest good for the greatest number of people. Following democratic principles or voting to determine an outcome is common when this stage of reasoning is invoked. In stage 6, moral reasoning is based on universal ethical principles. For example, the golden rule that you should do unto others as you would have them do unto you illustrates one such ethical principle. At this stage, laws are grounded in the idea of right and wrong. Thus individuals follow laws because they are just and not because they will be punished if caught or shunned by society. Consequently, with this stage there is an idea of civil disobedience that individuals have a duty to disobey unjust laws.

Table 10.4 Stages of Moral Development

Psychologist Lawrence Kohlberg theorized that a person's moral reasoning (which drives ethical behavior) has six identifiable stages spread across three levels. Each successive stage is superior to the previous stage with regard to responding to moral dilemmas. We illustrate each stage below.

Level 1 (Preconventional Level). Here moral reasoning is closely tied to personal concerns.

Stage 1. Obedience and punishment orientation (“How can I avoid punishment?”)	An individual’s motivation to behave ethically is driven by the fear of getting caught and punishment.
Stage 2. Self-interest orientation (“What’s in it for me?”)	Right or wrong is a function of rewards in this stage, where a “you scratch my back and I’ll scratch yours” mentality dominates.

Level 2 (Conventional Level). Here moral reasoning arises from comparing one’s actions with society’s expectations.

Stage 3. Interpersonal accord and harmony	Individuals act with the goal of fulfilling social roles, such as student, parent, and worker.
Stage 4. Authority and social order–maintaining orientation	The desire to maintain a functional society by obeying laws drives behaviors.

Level 1 (Preconventional Level). Here moral reasoning is closely tied to personal concerns.

Stage 5. Social contract orientation	Laws are viewed as social contracts that promote the greatest good for the greatest number of people. Unjust laws and policies must therefore be resisted.
Stage 6. Universal ethical principles	Moral reasoning is based on universal ethical principles such as the “golden rule” that you should treat others as you would want them to treat you.

Corporate Scandals and Sarbanes-Oxley

Table 10.5 Corporate Scandals

Celebrity scandals often create “buzz” and actually make celebrities richer. But scandals in the business world often lead to the forfeiture of millions of dollars as well as prison sentences. We illustrate some notable corporate scandals below.

<p>Ponzi schemes are named after Charles Ponzi, who in the 1920s paid returns to investors using money from new investors rather than firm profits. Inevitably this kind of scheme falls apart because it becomes impossible to attract enough new investors to pay existing ones. More than one wry cynic has noted the similarity between Ponzi schemes and how the Social Security system is funded.</p>	<p>Enron executives used accounting loopholes to create shell companies to hide billion in debt from failed deals and projects. Although these smug executives thought they were always “the smartest guys in the room,” the loss of \$11 billion in stock value and the prison time served by many of them proves otherwise.</p>	<p>Corruption was a family affair at Adelphia Communications Corporation, which was named after the Greek word for brothers. Adelphia was the fifth largest cable company in the United States until father and son team John and Timothy Rigas were found guilty on securities violations tied to their theft of \$100 million. Another Rigas son, Michael, pled guilty to falsifying financial reports.</p>
<p>First off the ground in 1930, American Airlines flew atop the headlines in 2009 when the <i>Wall Street Journal</i> accused the airline of hiding repeated maintenance lapses on over a dozen MD-80 aircraft.</p>	<p>Although Chiquita Brands sells healthy snacks, their corporate actions upset many stomachs in 2007 when they were fined \$25 million by the U.S. Justice Department for having ties to a Columbia paramilitary group on the department’s list of foreign terrorists organizations.</p>	<p>The Madoff investment scandal that broke in 2008 provided a modern twist on the classic Ponzi scheme. NASDAQ chairman Bernard Madoff pled guilty to eleven federal crimes that constituted the largest investor fraud ever committed by an individual. Madoff was sentenced to 150 years in prison.</p>

In the 1990s and early 2000s, several corporate scandals were revealed in the United States that showed a lack of board vigilance. Perhaps the most famous involves Enron, whose executive antics were documented in the film *The Smartest Guys in the Room*. Enron used accounting loopholes to hide billions of dollars in failed deals. When their scandal was discovered, top management cashed out millions in stock options while preventing lower-level employees from selling their stock. The collective acts of Enron led many employees to lose all their retirement holdings, and many Enron execs were sentenced to prison.

In response to notable corporate scandals at Enron, WorldCom, Tyco, and other firms, Congress passed sweeping new legislation with the hopes of restoring investor confidence while preventing future scandals (Table 10.5 “Corporate Scandals”). Signed into law by President George W. Bush in 2002, *Sarbanes-Oxley* contained eleven aspects that represented some of the most far-reaching reforms since the presidency of Franklin Roosevelt. These reforms create improved standards that affect all publicly traded firms in the United States. The key elements of each aspect of the act are summarized as follows:

1. Because accounting firms were implicated in corporate scandal, an oversight board was created to oversee auditing activities.
2. Standards now exist to ensure auditors are truly independent and not subject to conflicts of interest in regard to the companies they represent.
3. Enron executives claimed that they had no idea what was going on in their company, but Sarbanes-Oxley requires senior executives to take personal responsibility for the accuracy of financial statements.
4. Enhanced reporting is now required to create more transparency in regard to a firm’s financial condition.
5. Securities analysts must disclose potential conflicts of interest.

6. To prevent CEOs from claiming tax fraud is present at their firms, CEOs must personally sign the firm's tax return.
7. The Securities and Exchange Commission (SEC) now has expanded authority to censor or bar securities analysts from acting as brokers, advisers, or dealers.
8. Reports from the comptroller general are required to monitor any consolidations among public accounting firms, the role of credit agencies in securities market operations, securities violations, and enforcement actions.
9. Criminal penalties now exist for altering or destroying financial records.
10. Significant criminal penalties now exist for white-collar crimes.
11. The SEC can freeze unusually large transactions if fraud is suspected.

The changes that encouraged the creation of Sarbanes-Oxley were so sweeping that comedian Jon Stewart quipped, "Did Wall Street have any rules before this? Can you just shoot a guy for looking at you wrong?" Despite the considerable merits of Sarbanes-Oxley, no legislation can provide a cure-all for corporate scandal (Table 10.6 "Sarbanes-Oxley Act of 2002 (SOX)"). As evidence, the scandal by Bernard Madoff that broke in 2008 represented the largest investor fraud ever committed by an individual. But in contrast to some previous scandals that resulted in relatively minor punishments for their perpetrators, Madoff was sentenced to 150 years in prison.

Table 10.6 Sarbanes-Oxley Act of 2002 (SOX)

In the early 2000s, highly publicized fraud at Enron, WorldCom, Tyco, and other firms revealed significant issues including conflicts of interest by auditors and securities analysts, boardroom failures, and inadequate funding of the Securities and Exchange Commission. In response, Senator Paul Sarbanes and Representative Michael Oxley sponsored legislation that contained what former President George W. Bush called "the most far-reaching reforms of American business practices since the time of Franklin D. Roosevelt." We outline the eleven key aspects of the law below.

Accounting firms were complicit in some fraudulent events. In response, SOX created a board to oversee auditing activities within these firms.	To restore investor confidence in securities analysts, SOX expands the SEC's authority to censure or bar them from acting as a broker, advisor, or dealer.
Concerns about conflicts of interests arising from accounting firms acting as consultants and auditors for the same firm led SOX to establish standards to ensure that auditors would be truly independent.	The comptroller general and the SEC are now required to carefully monitor any consolidation among public accounting firms, the role of credit agencies in securities market operations, securities violations, and enforcement actions.
Senior executives must take individual responsibility for the accuracy of their firms' financial reports and they must forfeit the benefits arising from any non-compliance.	To preserve potentially incriminating documents, SOX creates criminal penalties for altering or destroying financial records.
To create more transparency, SOX enhances reporting standards for off-balance-sheet transactions and requires timely reporting of material changes in a firm's financial condition.	In the past, white collar crimes often received a proverbial slap on the wrist. SOX significantly increased the penalties associated with white-collar crimes and conspiracies.
Securities analysts must disclose any conflicts of interest involving a firm.	In response to past fraud and records tampering, the SEC can temporarily freeze transactions deemed unusually large.
The CEO is required to sign his/her firm's tax return. This may prevent CEOs from claiming that they did not know tax fraud was occurring within their firms.	

Measuring Corporate Social Performance

TOMS Shoes' commitment to donating a pair of shoes for every shoe sold illustrates the concept of [social entrepreneurship](#), in which a business is created with a goal of bettering both business and society (Schechtman, 2010). Firms such as TOMS exemplify a desire to improve [corporate social performance \(CSP\)](#) in which a commitment to individuals, communities, and the natural environment is valued alongside the goal of creating economic value. Although determining the level of a firm's social responsibility is subjective, this challenge has been addressed in detail by Kinder, Lydenberg and Domini & Co. (KLD), a Boston-based firm that rates firms on a number of stakeholder-related issues with the goal of measuring CSP. KLD conducts ongoing research on social, governance, and environmental performance metrics of publicly traded firms and reports such statistics to institutional investors. The KLD database provides ratings on numerous "strengths" and "concerns" for each firm along a number of dimensions associated with corporate social performance ([Table 10.7 "Measuring Corporate Social Performance"](#)). The results of their assessment are used to develop the Domini social investments fund, which has performed at levels roughly equivalent to the S&P 500.

Table 10.7 Measuring Corporate Social Performance

Corporate social performance is defined as the degree to which a firm's actions honor ethical values that respect individuals, communities, and the natural environment. Determining whether a firm is socially responsible is somewhat subjective, but one popular approach has been developed by KLD Research & Analytics. Their work tracks "strengths" and "concerns" for hundreds of firms over time. KLD's findings are used by investors to screen socially responsible firms and by scholars who are interested in explaining corporate social performance. We illustrate the six key dimensions tracked by KLD below.

<p>Community strengths include engagement in charitable giving, while involvement in tax controversies exemplifies a community concern.</p>	<p>Product quality/safety strengths include actions such as the establishment of a well-developed quality program, while concerns arise if a firm receives fines related to product quality and/or safety.</p>	<p>Diversity strengths include progressive programs for the employment of the disabled, whereas fines or civil penalties that result from an affirmative action constitute a concern.</p>
<p>A no-layoff policy is a strength in regard to employee relations, while poor union relations are a concern.</p>	<p>Environmental strengths include engaging in recycling, while concerns arise when penalties for air or water violations are documented.</p>	<p>Corporate governance strengths include equitable levels of compensation for top management and board members, while concerns are raised if controversies related to accounting, transparency, or political accountability are discovered.</p>

Assessing the community dimension of CSP is accomplished by assessing community strengths, such as charitable or innovative giving that supports housing, education, or relations with indigenous peoples, as well as charitable efforts worldwide, such as volunteer efforts or in-kind giving. A firm's CSP rating is lowered when a firm is involved in tax controversies or other negative actions that affect the community, such as plant closings that can negatively affect property values.



Chick-fil-A encourages education through their program that has provided more than \$25 million in financial aid to more than twenty-five thousand employees since 1973.

Ann Larie Valentine – [Chik-fil-A](#) – CC BY-SA 2.0.

CSP diversity strengths are scored positively when the company is known for promoting women and minorities, especially for board membership and the CEO position. Employment of the disabled and the presence of family benefits such as child or elder care would also result in a positive score by KLD. Diversity concerns include fines or civil penalties in conjunction with an affirmative action or other diversity-related controversy. Lack of representation by women on top management positions—suggesting that a glass ceiling is present at a company—would also negatively impact scoring on this dimension.

The employee relations dimension of CSP gauges potential strengths such as notable union relations, profit sharing and employee stock-option plans, favorable retirement benefits, and positive health and safety programs noted by the US Occupational Health and Safety Administration. Employee relations concerns would be evident in poor union relations, as well as fines paid due to violations of health and safety standards. Substantial workforce reductions as well as concerns about adequate funding of pension plans also warrant concern for this dimension.

The environmental dimension records strengths by examining engagement in recycling, preventing pollution, or using alternative energies. KLD would also score a firm positively if profits derived from environmental products or services were a part of the company's business. Environmental concerns such as penalties for hazardous waste, air, water, or other violations or actions such as the production of goods or services that could negatively impact the environment would reduce a firm's CSP score.

Product quality/safety strengths exist when a firm has an established and/or recognized quality program; product quality safety concerns are evident when fines related to product quality and/or safety have been discovered or when a firm has been engaged in questionable marketing practices or paid fines related to antitrust practices or price fixing.

Corporate governance strengths are evident when lower levels of compensation for top management and board members exist, or when the firm owns considerable interest in another company rated favorably by KLD; corporate

governance concerns arise when executive compensation is high or when controversies related to accounting, transparency, or political accountability exist.

Strategy at the Movies

Thank You for Smoking

Does smoking cigarettes cause lung cancer? Not necessarily, according to a fictitious lobbying group called the Academy of Tobacco Studies (ATS) depicted in *Thank You for Smoking* (2005). The ATS's ability to rebuff the critics of smoking was provided by a three-headed monster of disinformation: scientist Erhardt Von Grupten Mundt who had been able to delay finding conclusive evidence of the harms of tobacco for thirty years, lawyers drafted from Ivy League institutions to fight against tobacco legislation, and a spin control division led by the smooth-talking Nick Naylor.

The ATS was a promotional powerhouse. In just one week, the ATS and its spin doctor Naylor distracted the American public by proposing a \$50 million campaign against teen smoking, brokered a deal with a major motion picture producer to feature actors and actresses smoking after sex, and bribed a cancer-stricken advertising spokesman to keep quiet. But after the ATS's transgressions were revealed and cigarette companies were forced to settle a long-standing class-action lawsuit for \$246 billion, the ATS was shut down. Although few organizations promote a product as harmful as cigarettes, the lessons offered in *Thank You for Smoking* have wide application. In particular, the film highlights that choosing between ethical and unethical business practices is not only a moral issue, but it can also determine whether an organization prospers or dies.



In *Thank You for Smoking*, lobbyist Nick Naylor faces the difficult task of making smoking sexy in an era when the health hazards of this practice are well known.

Marco – Clef de Peau – [Smoke](#) – CC BY-NC-ND 2.0.

Key Takeaway

- The work of Lawrence Kohlberg examines how individuals can progress in their stages of moral development. Lack of such development by many CEOs led to a number of scandals, as well as legislation such as the Sarbanes-Oxley Act of 2002 that was enacted with the hope of deterring scandalous behavior in the future. Firms such as KLD provide objective measures of both positive and negative actions related to corporate social performance.

Exercises

1. How would your college or university fare if rated on the dimensions used by KLD?
2. Do you believe that executives will become more ethical based on legislation such as Sarbanes-Oxley?

References

- Kohlberg, L. 1981. *Essays in moral development: Vol. 1. The philosophy of moral development*. New York, NY: Harper & Row.
- Schectman, J. 2010. Good business. *Newsweek*, 156, 50.

10.4 Understanding Thought Patterns: A Key to Corporate Leadership?

Learning Objectives

1. Know the three major generational influences that make up the majority of the current workforce and their different perspectives and influences.
2. Understand how decision biases may impede effective decision making.

Generational Influences on Work Behavior

Psychologist Kurt Lewin, known as the “founder of social psychology,” created a well-known formula $B = f(P,E)$ that states behavior is a function of the person and their environment. One powerful environmental influence that can be seen in organizations today is based on generational differences. Currently, four generations of workers (traditionalists, baby boomers, Generation X, Generation Y) coexist in many organizations. The different backgrounds and behaviors create challenges for leading these individuals that often have similar shared experiences within their generation but different sets of values, motivations, and preferences in contrast to other generations (Table 10.8 “Managing Generational Differences”). Effective management of these four different generations involves a realization of their differences and preferred communication styles (Rathman, 2011).

The generation born between 1925 and 1946 that fought in World War II and lived through the Great Depression are referred to as **traditionalists**. The perseverance of this generation has led journalist Tom Brokaw to dub this group “The Greatest Generation.” As a reflection of a generation that was molded by contributions to World War II, members of this generation value personal communication, loyalty, hierarchy, and are resistant to change. This group now makes up roughly 5 percent of the workforce.

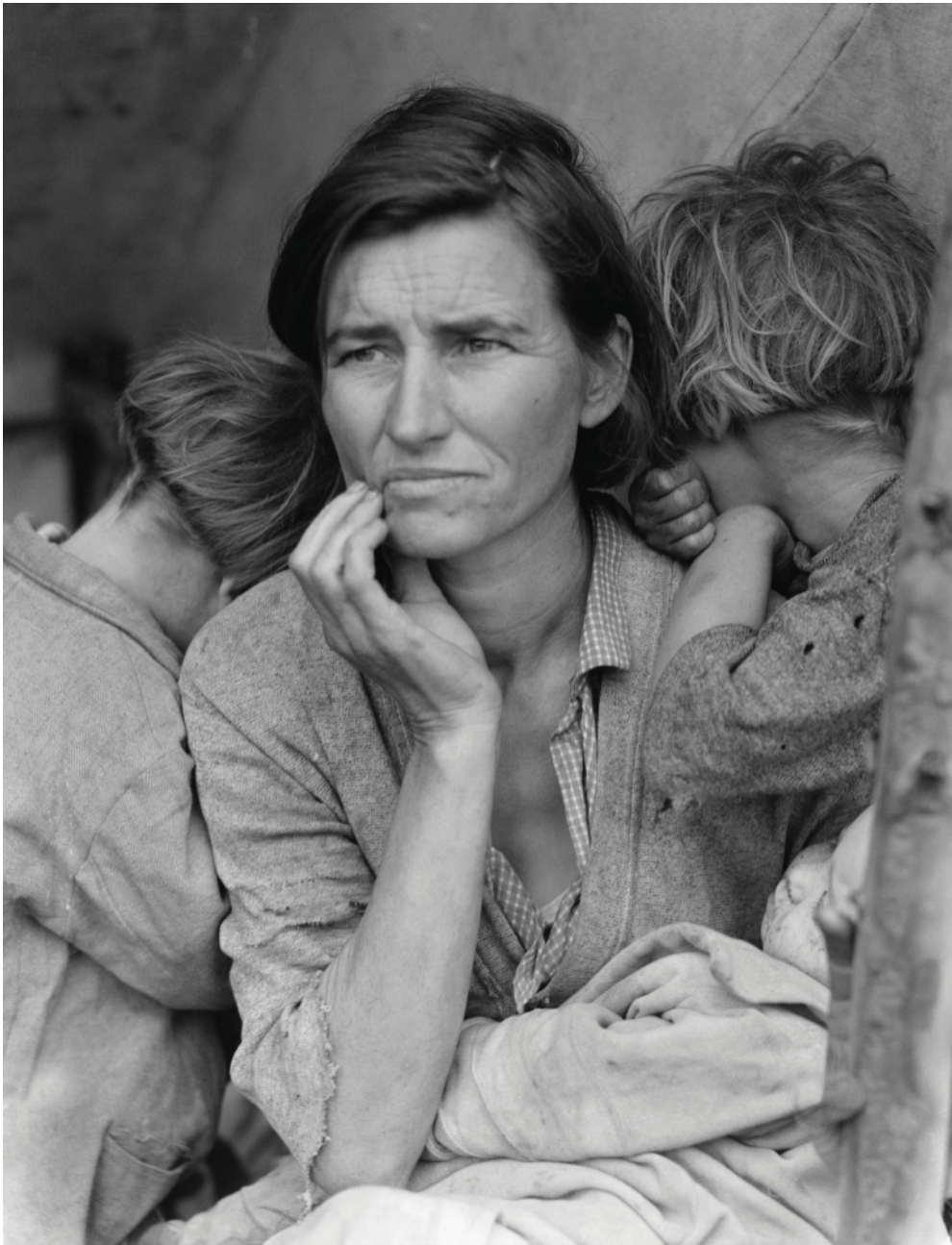

Photographer Dorothea Lange's photo *Migrant Mother*, taken in 1936, embodied the struggles of the traditionalist generation that lived during the Great Depression.

[Wikimedia Commons](#) – public domain.

The generation known as [baby boomers](#) was born between 1946 and 1964, corresponding with a population “boom” following the end of World War II. This group witnessed Beatlemania, Vietnam, and the Watergate scandal. College graduates should be aware that this group makes up the majority of the workforce and that boomer managers often view face time as an important contribution to a successful work environment (Fogg, 2008). In addition, a

realization that this generation wants to be included in office activities and values recognition is important to achieving cohesiveness between generations.

Generation X, born between 1965 and 1980, is marked by an X symbolizing their unknown nature. In contrast to the baby boomer's value on office face time, Gen X members prize flexibility in their jobs and dislike the feeling that they are being micromanaged (Burk, et. al., 2011). Because of the desire for independence as well as adaptability associated with this generation, you should try to answer the "What's in it for me?" question to avoid the risk of Gen X members moving on to other employment opportunities.

The generation that followed Generation X is known as **Generation Y** or millennials. This generation is highlighted by positive attributes such as the ability to embrace technology. More than previous generations, this group prizes job and life satisfaction highly, so making the workplace an enjoyable environment is key to managing Generation Y.

Table 10.8 Managing Generational Differences

To effectively lead today's corporations, knowledge of the firm's products and services are not enough. Executives must understand how to manage an increasingly diverse workforce. For example, navigating the differences among the three generations that currently dominate the workforce is crucial. We illustrate some of these differences below. One important caveat is that not all members of each generation fit these general descriptions.

Baby Boomers (1946-1964)	Generation X (1965-1980)	Generation Y (1981-1990)
Background: Children of the post World War II “baby boom” grew up during dramatic social events including Beatlemania, the first moon walk, the Vietnam War, and Watergate.	Background: Generation X refers to the unknown nature of this generation, who grew up amid an increasing divorce rate as well as political experiences such as the end of the Cold War and fall of the Berlin Wall.	Background: Known also as the Millennial Generation, this group is comfortable with technology, and is often associated with “helicopter” parents who are far more involved in their children’s lives than parents have been in the past. Because of the trend toward valuing participation in competitive activities rather than outcomes, this group is sometimes called the “Trophy Generation.”
General characteristics: Optimism, politically conservative, competitive.	General characteristics: Independent, cynical, adaptable.	General characteristics: Team-oriented, technologically savvy, need considerable feedback.
Communication preferences: Increased accessibility to touch phones reduces the need for interaction with this group, where a quick phone call can be effective to convey a message.	Communication preferences: The ability to reach out by mobile phone anytime is the hallmark of this generation.	Communication preferences: Pictures, personal details, and immediate access to friends and family.
What you should know to manage this group: This group makes up the majority of the work force, and this group is susceptible to burnout and stress-related illness. Be sure to not scrimp on praise and the funding of office parties for this group that values recognition and enjoys begin part of a group.	What you should know to manage this group: Because of their independence and adaptability, this group is especially prone to switching jobs to climb the career ladder. Micromanaging this group is rarely effective, but providing flexibility as well as being able to answer the question, “What’s in it for me?” can be helpful.	What you should know to manage this group: Job and life satisfaction is the key to keeping this generation’s talent so the opportunity to make work fun should not be downplayed with this group, and providing feedback is an important role in managing this generation that has often been coddled.

Wise members of this generation will also be aware of the negative attributes surrounding them. For example, millennials are associated with their “helicopter” parents who are often too comfortably involved in the lives of their children. For example, such parents have been known to show up to their children’s job orientations, often attempting to interfere with other workplace experiences such as pay and promotion discussions that may be unwelcome by older generations. In addition, this generation is viewed as needing more feedback than previous groups. Finally, the trend toward discouraging some competitive activities among individuals in this age group has led millennials to be dubbed “Trophy Kids” by more cynical writers.

Rational Decision Making

Understanding generational differences can provide valuable insight into the perspectives that shape the behaviors of individuals born at different periods of time. But such knowledge does not answer a more fundamental question of interest to students of strategic management, namely, why do CEOs make bad, unethical, or other questionable decisions with the potential to lead their firms to poor performance or firm failure? Part of the answer lies in the method by which CEOs and other individuals make decisions. Ideally, individuals would make rational decisions for important choices such as buying a car or house, or choosing a career or place to live. The process of rational decision making involves problem identification, establishment and weighing of decision criteria, generation and evaluation of alternatives, selection of the best alternative, decision implementation, and decision evaluation.



Rational Decision-Making Model

While this model provides valuable insights by providing an ideal approach by which to make decisions, there are several problems with this model when applied to many complex decisions. First, many strategic decisions are not presented in obvious ways, and many CEOs may not be aware their firms are having problems until it's too late to create a viable solution. Second, rational decision making assumes that options are clear and that a single best solution exists. Third, rational decision making assumes no time or cost constraints. Fourth, rational decision making assumes accurate information is available. Because of these challenges, some have joked that marriage is one of the least rational decisions a person can make because no one can seek out and pursue every possible alternative—even with all the online dating and social networking services in the world.

Decision Biases

In reality, decision making is not rational because there are limits on our ability to collect and process information. Because of these limitations, Nobel Prize-winner Herbert Simon argued that we can learn more by examining scenarios where individuals deviate from the ideal. These decision biases provide clues to why individuals such as CEOs make decisions that in retrospect often seem very illogical—especially when they lead to actions that damage the firm and its performance. A number of the most common biases with the potential to affect business decision making are discussed next.

Table 10.9 Decision Biases

Nobel prize winner Herbert Simon argued that we can learn much about decision making by examining where we deviate from ideal decisions. We summarize a number of the most common decision biases below.

Anchoring and adjustment bias occurs when individuals react to arbitrary or irrelevant numbers when setting financial or other numerical targets.
Availability bias occurs when more readily available information is incorrectly assessed to also be more likely.
Escalation of commitment bias occurs when individuals continue on a failing course of action even after it becomes clear that this may be a poor path to follow.
Fundamental attribution error occurs when good outcomes are attributed to personal characteristics (e.g., intelligence) but undesirable outcomes are attributed to external circumstances (e.g., the weather).
Hindsight bias occurs when mistakes seem obvious after they have already occurred.
Judgements about correlation and causality bias occurs when individuals make inaccurate attribution about the causes of events.
Misunderstandings about sampling bias occurs when individuals draw broad conclusions from small sets of observations instead of more reliable sources of information derived from large, randomly drawn samples.
Overconfidence bias occurs when individuals are more confident in their abilities to predict an event than logic suggests is actually possible.
Representativeness and framing bias occurs when the way information is presented alters the decision an individual will make.
Satisficing occurs when individuals settle for the first acceptable alternative instead of seeking the best possible (optimal) decision.

Anchoring and adjustment bias occurs when individuals react to arbitrary or irrelevant numbers when setting financial or other numerical targets. For example, it is tempting for college graduates to compare their starting salaries at their first career job to the wages earned at jobs used to fund school. Comparisons to siblings, friends, parents, and others with

different majors are also very tempting while being generally irrelevant. Instead, research the average starting salary for your background, experience, and other relevant characteristics to get a true gauge. This bias could undermine firm performance if executives make decisions about the potential value of a merger or acquisition by making comparisons to previous deals rather than based on a realistic and careful study of a move's profit potential (Table 10.9 "Decision Biases").

The **availability bias** occurs when more readily available information is incorrectly assessed to also be more likely. For example, research shows that most people think that auto accidents cause more deaths than stomach cancer because auto accidents are reported more in the media than deaths by stomach cancer at a rate of more than 100 to 1. This bias could cause trouble for executives if they focus on readily available information such as their own firm's performance figures but fail to collect meaningful data on their competitors or industry trends that suggest the need for a potential change in strategic direction.

The idea of "throwing good money after bad" illustrates the bias of **escalation of commitment**, when individuals continue on a failing course of action even after it becomes clear that this may be a poor path to follow. This can be regularly seen at Vegas casinos when individuals think the next coin must be more likely to hit the jackpot at the slots. The concept of escalation of commitment was chronicled in the 1990 book *Barbarians at the Gate: The Rise and Fall of RJR Nabisco*. The book follows the buyout of RJR Nabisco and the bidding war that took place between then CEO of RJR Nabisco F. Ross Johnson and leverage buyout pioneers Henry Kravis and George Roberts. The result of the bidding war was an extremely high sales price of the company that resulted in significant debt for the new owners.



Providing an excellent suggestion to avoid a nonrational escalation of commitment, old school comedian W. C. Fields once advised, "If at first you don't succeed, try, try again. Then quit. There's no point being a damn fool about it."

[Wikimedia Commons](#) – public domain.

Fundamental attribution error occurs when good outcomes are attributed to personal characteristics but undesirable outcomes are attributed to external circumstances. Many professors lament a common scenario that, when a student does well on a test, it's attributed to intelligence. But when a student performs poorly, the result is attributed to an unfair test or lack of adequate teaching based on the professor. In a similar vein, some CEOs are quick to take

credit when their firm performs well, but often attribute poor performance to external factors such as the state of the economy.

Hindsight bias occurs when mistakes seem obvious after they have already occurred. This bias is often seen when second-guessing failed plays on the football field and is so closely associated with watching National Football League games on Sunday that the phrase Monday morning quarterback is a part of our business and sports vernacular. The decline of firms such as Kodak as victims to the increasing popularity of digital cameras may seem obvious in retrospect. It is easy to overlook the poor quality of early digital technology and to dismiss any notion that Kodak executives had good reason not to view this new technology as a significant competitive threat when digital cameras were first introduced to the market.

Judgments about correlation and causality can lead to problems when individuals make inaccurate attributions about the causes of events. Three things are necessary to determine cause—or why one element affects another. For example, understanding how marketing spending affects firm performance involves (1) correlation (do sales increase when marketing increases), (2) temporal order (does marketing spending occur before sales increase), and (3) ruling out other potential causes (is something else causing sales to increase: better products, more employees, a recession, a competitor went bankrupt, etc.). The first two items can be tracked easily, but the third is almost impossible to isolate because there are always so many changing factors. In economics, the expression *ceteris paribus* (all things being equal or constant) is the basis of many economic models; unfortunately, the only constant in reality is change. Of course, just because determining causality is difficult and often inconclusive does not mean that firms should be slow to take strategic action. As the old business saying goes, “We know we always waste half of our marketing budget, we just don’t know which half.”

Misunderstandings about sampling may occur when individuals draw broad conclusions from small sets of observations instead of more reliable sources of information derived from large, randomly drawn samples. Many CEOs have been known to make major financial decisions based on their own instincts rather than on careful number crunching.

Overconfidence bias occurs when individuals are more confident in their abilities to predict an event than logic suggests is actually possible. For example, two-thirds of lawyers in civil cases believe their side will emerge victorious. But as the famed Yankees player/manager Yogi Berra once noted, “It’s hard to make predictions, especially about the future.” Such overconfidence is common in CEOs that have had success in the past and who often rely on their own intuition rather than on hard data and market research.

Representativeness bias occurs when managers use stereotypes of similar occurrences when making judgments or decisions. In some cases, managers may draw from previous experiences to make good decisions when changes in the environment occur. In other cases, representativeness can lead to discriminatory behaviors that may be both unethical and illegal.

Framing bias occurs when the way information is presented alters the decision an individual will make. Poor framing frequently occurs in companies because employees are often reluctant to bring bad news to CEOs. To avoid an unpleasant message, they might be tempted to frame information in a more positive light than reality, knowing that individuals react differently to news that a glass is half empty versus half full.

Satisficing occurs when individuals settle for the first acceptable alternative instead of seeking the best possible (optimal) decision. While this bias might actually be desirable when others are waiting behind you at a vending machine, research shows that CEOs commonly satisfice with major decisions such as mergers and takeovers.

Key Takeaway

- Generational differences provide powerful influences on the mind-set of employees that should be

carefully considered to effectively manage a diverse workforce. Wise managers will also be aware of the numerous decision biases that could impede effective decision making.

Exercises

1. Explain how a specific decision bias mentioned in this chapter led to poor decision making by a firm.
2. Are there negative generational tendencies in your age group that you have worked to overcome?

References

Burk, B., Olsen, H., & Messerli, E. 2011, May. Navigating the generation gap in the workplace from the perspective of Generation Y. *Parks & Recreation*, 35–36.

Fogg, P. 2008, July 18. When generations collide: Colleges try to prevent age-old culture clashes as four distinct groups meet in the workplace. *Education Digest*, 25–30.

Rathman, V. 2011. Four generations at work. *Oil & Gas*, 109, 10.

10.5 Conclusion

This chapter explains the role of boards of directors in the corporate governance of organizations such as large, publicly traded corporations. Wise boards work to manage the agency problem that creates a conflict of interest between top managers such as CEO and other groups with a stake in the firm. When boards fail to do their duties, numerous scandals may ensue. Corporate scandals became so widespread that new legislation such as the Sarbanes-Oxley Act of 2002 has been developed with the hope of impeding future actions by executives associated with unethical or illegal behavior. Finally, firms should be aware of generational influences as well as other biases that may lead to poor decisions.

Exercises

1. Divide your class into four or eight groups, depending on the size of the class. Each group should select a different industry. Find positive and negative examples of corporate social performance based on the dimensions used by KLD.
2. This chapter discussed Blake Mycoskie and TOMS Shoes. What other opportunities exist to create new organizations that serve both social and financial goals?